

FESTA[®]

PROFESSIONAL  TOOLS

20

23

24





Brand of high quality hand tools for building, workshop and garden



Brand of top quality levels



Brand of high quality levels and mason staff



Comprehensive group of battery products using quality components, the latest technologies and current trends in battery tools



Professional watering assortment with modern design, compatible with Rosa product line



Quality watering systems and garden tools



Japanese knives with a long tradition



Professional measuring tapes



Professional tile cutter



Manufacturer of quality garden shears



Professional building mixers



Professional screwdriver attachments



Brand of professional saws

FESTA

POWER X TOOLS

SHARE
20V

Li-ion
technology



CORDLESS ELECTRIC
POWER TOOLS

2 - 23



BRUSHLESS **SHARE** **20V** *Li-ion technology*

speed
0-550 min⁻¹
0-2000 min⁻¹

mass
with battery 2,0 Ah **1,8 kg**
with battery 4,0 Ah **2,1 kg**

torque
80 Nm

chuck
2 - 13 mm



- The set contains:
- hammer drill
 - 2.0 Ah battery
 - 4.0 Ah battery
 - 2.4 A charger
 - additional handle
 - suitcase



FESTA
POWER X TOOLS

HAMMER DRILL CORDLESS

max 80 Nm		I.O-8800 bpm II.O-32000 bpm	I.O-550min ⁻¹ II.O-2000min ⁻¹							
				2-13 mm				1,4 kg		

BRUSHLESS SHARE 20V *Li-ion technology*

speed
0-550 min⁻¹
0-2000 min⁻¹

mass
with battery 2,0 Ah **1,8 kg**
with battery 4,0 Ah **2,1 kg**

torque
80 Nm

chuck
2 – 13 mm

The set contains:
- hammer drill
- 2.0 Ah battery
- 2.4 A charger
- additional handle
- suitcase



mode selection
choice of torque force

additional handle

speed switch

quick release
chuck head

direction of
rotation switch

ergonomic rubberized
handle for a comfortable
and secure grip

LED lighting

hook for hanging

battery lock



HAMMER DRILL CORDLESS

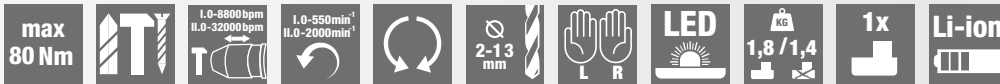

No. specifications
28001

2

BRUSHLESS SHARE 20V

speed
0-550 min⁻¹
0-2000 min⁻¹

mass
without battery
1,4 kg

torque
80 Nm

chuck
2 – 13 mm

mode selection
choice of torque force

additional handle

speed switch

quick release
chuck head

direction
of rotation switch

ergonomic rubberized
handle for a comfortable
and secure grip

LED lighting

hook for hanging

Accessories

- 28080 Battery 2,0 Ah
- 28081 Battery 4,0 Ah
- 28085 Charger 2,4 A
- 28086 Charger 4,0 A



HAMMER DRILL CORDLESS



*battery not included

No. specifications
28002

5

SHARE
20V

Li-ion
technology

speed
0-500 min⁻¹
0-1800 min⁻¹

mass
with battery **2,0 Ah**
1,7 kg

torque
45 Nm

chuck
2 – 13 mm

The set contains:

- hammer drill
- 2x 2.0 Ah Battery
- 2.4 A charger
- suitcase
- carrier and bits:

- ⊖ S5, S6 x 25 mm
- ⊕ PH1, PH2 x 25 mm
- ⊕ PZ1, PZ2 x 25 mm
- HSS drills
- 2-2.5-3-4-5-6 mm



mode selection
choice of torque force

quick release
chuck head

speed switch

direction of rotation

ergonomic rubberized
handle for a comfortable
and secure grip

LED lighting

hook for hanging

battery lock



FESTA
POWER X TOOLS

HAMMER DRILL CORDLESS

max 45 Nm		0-19200 bpm	0-500min ⁻¹ 0-1800min ⁻¹		2-13 mm		LED	1,7 / 1,3	2x	Li-ion
--------------	--	----------------	---	--	------------	--	------------	-----------	----	--------



No. specifications
28003



3

SHARE
20V

speed
0-550 min⁻¹
0-2000 min⁻¹

mass
without battery
1,4 kg

torque
80 Nm

chuck
2 – 13 mm

mode selection
choice of torque force

quick release
chuck head

speed switch

direction of rotation

ergonomic rubberized
handle for a comfortable
and secure grip

LED lighting

hook for hanging



Accessories

28080 Battery 2,0 Ah

28081 Battery 4,0 Ah

28085 Charger 2,4 A

28086 Charger 4,0 A



FESTA
POWER X TOOLS

HAMMER DRILL CORDLESS

max 45 Nm		0-19200 bpm	0-500min ⁻¹ 0-1800min ⁻¹		2-13 mm		LED	1,4
--------------	--	----------------	---	--	------------	--	------------	-----

*battery not included

No. specifications
28004



5

SHARE
20V *Li-ion*
technology

speed
0-350 min⁻¹
0-1300 min⁻¹

mass
with battery 2,0 Ah
1,3 kg

torque
28 Nm

chuck
1 - 10 mm

- The set contains:
- hammer drill
 - 2x 2.0 Ah Battery
 - 2.4 A charger
 - suitcase
 - carrier and bits:
 - ⊖ S5, S6 x 25 mm
 - ⊕ PH1, PH2 x 25 mm
 - ⊕ PZ1, PZ2 x 25 mm
 - drills HSS
 - 1,5-2,5-3-4-5-6 mm



mode selection
choice of torque force

quick release
chuck head

speed switch

direction of
rotation switch

ergonomic rubberized
handle for a comfortable
and secure grip

LED lighting

battery lock

hook for hanging



DRILL CORDLESS SCREWDRIVER

max 28 Nm		L0-350min ⁻¹ H0-1300min ⁻¹				LED		2x	Li-ion
				1-10 mm	L R		1,3 / 0,9		



No. specifications
28005

3

SHARE
20V

speed
0-350 min⁻¹
0-1300 min⁻¹

mass
without battery
0,9 kg

torque
28 Nm

chuck
1 - 10 mm

Accessories

- 28080 Battery 2,0 Ah
- 28081 Battery 4,0 Ah
- 28085 Charger 2,4 A
- 28086 Charger 4,0 A



mode selection
choice of torque force

quick release
chuck head

speed switch

direction of
rotation switch

ergonomic rubberized
handle for a comfortable
and secure grip

LED lighting

hook for hanging



DRILL CORDLESS SCREWDRIVER

max 28 Nm		L0-350min ⁻¹ H0-1300min ⁻¹				LED	
				1-10 mm	L R		0,9

*battery not included

No. specifications
28006



5

Li-ion
technology

speed
0-350 min⁻¹
0-1300 min⁻¹

mass
with battery 1,5 Ah
1 kg

torque
20 Nm

chuck
1 - 10 mm

- The set contains:
- hammer drill
 - 2x battery 12 V | 1.5 Ah
 - charger 12 V | 2.4 A
 - suitcase
 - carrier and bits:
 - ⊖ S5, S6 x 25 mm
 - ⊕ PH1, PH2 x 25 mm
 - ⊕ PZ1, PZ2 x 25 mm
 - drills HSS
1,5-2,5-3-4-5-6 mm



mode selection
choice of torque force

quick release
chuck head

speed switch

LED lighting

battery charge indicator

direction of
rotation

ergonomic rubberized
handle for a comfortable
and secure grip

battery



FESTA
POWER X TOOLS

DRILL CORDLESS SCREWDRIVER

max 20 Nm		1.0-350min ⁻¹ 0.0-1300min ⁻¹				LED		2x	Li-ion
--------------	--	---	--	--	--	-----	--	----	--------



No. specifications
28007

5

Li-ion
technology

speed
without load
200 min⁻¹

mass
with battery 1,5 Ah
0,4 kg

maximum torque
3 Nm

tool carrier
1/4" hexagon

- The set contains:
- screwdriver
 - charger 5 V | 0,5 A
 - carrier and bits:
 - ⊖ S5 x 50 mm
 - ⊕ PH1 x 50 mm
 - ⊕ PH2 x 50 mm
 - ⊕ H5 x 50 mm
 - ⊕ T20 x 50 mm

1/4 "quick-release
head with fuse

settings torque

battery charge indicator

setting lock
handle position

LED lighting

direction of
rotation switch

ergonomic rubberized
handle for a comfortable
and secure grip



LED lighting



FESTA
POWER X TOOLS

CORDLESS SCREWDRIVER

max 3 Nm	200min ⁻¹	1/4"		LED	0,4	Li-ion	3,6 V	1,5 Ah
-------------	----------------------	------	--	-----	-----	--------	-------	--------



No. specifications
28008

10

SHARE
20V

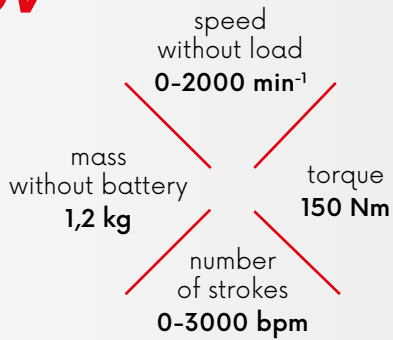

1/4 „quick-release head with fuse

selectable direction of rotation

ergonomic rubberized handle for a comfortable and secure grip

LED lighting

hook for hanging



Accessories

- 28080 Battery 2,0 Ah
- 28081 Battery 4,0 Ah
- 28085 Charger 2,4 A
- 28086 Charger 4,0 A



CORDLESS IMPACT WRENCH

max 150 Nm	0-2000min ⁻¹	0-3000bpm	1/4"	↻	L R	LED	KG 1,2
---------------	-------------------------	-----------	------	---	-----	-----	-----------

*battery not included

No. specifications
28021



SHARE
20V



depth stop

work mode switching (with / without percussion)

SDS clamping tool head

speed switch

direction of rotation switch



Accessories

- 28080 Battery 2,0 Ah
- 28081 Battery 4,0 Ah
- 28085 Charger 2,4 A
- 28086 Charger 4,0 A



CORDLESS HAMMER DRILL

IT	I.0-300 min ⁻¹ II.0-1000 min ⁻¹	0-5000 bpm	↻	SDS+	L R	KG 1,7
----	--	------------	---	------	-----	-----------

*battery not included

No. specifications
28025



SHARE
20V

frequency shooting
60-100 min⁻¹

maximum length nails / staples
30 mm hard materials

maximum length nails / staples
50 mm soft materials

mass without battery
2,7 kg



Accessories

- 28080 Battery 2,0 Ah
- 28081 Battery 4,0 Ah



- 28085 Charger 2,4 A
- 28086 Charger 4,0 A



Nails

- 23930 Nailing nail 30 mm, 2000 pcs
- 23931 Nailing nail 40 mm, 2000 pcs
- 23932 Nailing nail 50 mm, 2000 pcs

Buckle

- 23935 Nail clip 30 mm, 2000 pcs
- 23936 Nail clip 40 mm, 2000 pcs

Suitable types of nails and staples:

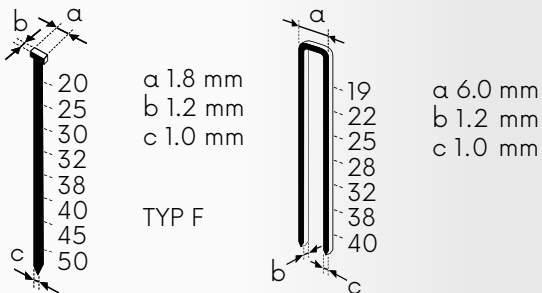

CORDLESS NAILER AND STAPLER

max 60 min⁻¹ | TYPE F | LED | 2,7 kg

*battery not included

No.	specifications
28070	



SHARE
20V

color temperature
6000 K

mass without battery
1,6 kg

LED power
30W

luminous flux
1800 lm (100%)
1000 lm (60%)
500 lm (30%)



360° swivel head adjustment

flange for mounting

setting the light intensity
30%, 60%, 100%



Accessories

- 28080 Battery 2,0 Ah
- 28081 Battery 4,0 Ah
- 28085 Charger 2,4 A
- 28086 Charger 4,0 A



LED LIGHT AKU

30W	1800 lumen	IP44	>120°
-----	------------	------	-------

*battery not included

No.	specifications
28065	



BRUSHLESS SHARE 20V

speed without load
8500 min⁻¹

mass without battery
1,6 kg

maximum thickness cut material
15 mm

maximal wheel diameter
125 mm



Accessories

- 28080 Battery 2,0 Ah
- 28081 Battery 4,0 Ah
- 28085 Charger 2,4 A
- 28086 Charger 4,0 A



CORDLESS ANGLE GRINDER

8500 min ⁻¹	max ∅ 125mm	M14		1,6 KG
------------------------	-------------------	-----	--	-----------

*battery and disc are not included

No.	specifications
28030	

SHARE 20V

speed without load
8000 min⁻¹

mass without battery
1,6 kg

maximum thickness cut material
15 mm

maximal wheel diameter
115 mm



Accessories

- 28080 Battery 2,0 Ah
- 28081 Battery 4,0 Ah
- 28085 Charger 2,4 A
- 28086 Charger 4,0 A



CORDLESS ANGLE GRINDER

8000 min ⁻¹	max ∅ 115mm	M14		1,6 KG
------------------------	-------------------	-----	--	-----------

*battery and disc are not included

No.	specifications
28032	

SHARE
20V

speed without load
10000 min⁻¹

mass without battery
1 kg

eccentricity wheels
5 mm

diameter wheels
125 mm



Accessories

- 28080 Battery 2,0 Ah
- 28081 Battery 4,0 Ah
- 28085 Charger 2,4 A
- 28086 Charger 4,0 A



BATTERY ORBITAL SANDER



*battery not included

No. specifications
28040



SHARE
20V

number of oscillations without load
5000-15000 min⁻¹

mass without battery
1 kg

speed control



Accessories

- 28080 Battery 2,0 Ah
- 28081 Battery 4,0 Ah
- 28085 Charger 2,4 A
- 28086 Charger 4,0 A



CORDLESS DEVICE MULTI-FUNCTIONAL



*battery not included

No. specifications
28045



SHARE
20V



speed without load
3650 min⁻¹

adjustable angle of inclination of the cut
45-90 degrees

max. diameter wheels
165 mm
(ø16 mm)

maximum cut
50 mm
* at an angle of 90 degrees with disc ø165 mm



Accessories

- 28080 Battery 2,0 Ah
- 28081 Battery 4,0 Ah
- 28085 Charger 2,4 A
- 28086 Charger 4,0 A



CORDLESS CIRCULAR SAW



* battery not included

No.	specifications
28035	a saw blade is part of the package ø165x16 mm 24T



SHARE
20V

ergonomic rubberized handle for a comfortable and secure grip

number of blade strokes
0-2400 min⁻¹

fuse operating switch

mass without battery
1,8 kg

max. angle bevel cut
45 degrees

max. cut profile
steel: 6 mm
wood: 80 mm

pre-oscillation setting

LED

paw slope locking

Accessories

28080 Battery 2,0 Ah

28081 Battery 4,0 Ah

28085 Charger 2,4 A

28086 Charger 4,0 A



bar locking

base

guide rail



CORDLESS JIGSAW



*battery not included

No. specifications

28050



4



bevel the cut

0°
45° 45°

SHARE
20V

number of oscillations without load
0-3000 min⁻¹

fuse operating switch

mass without battery
1,7 kg

max. cutting thickness
Wood: 100 mm
Steel: 5 mm
aluminum/ copper: 20 mm



ergonomic rubberized handle for a comfortable and secure grip

Accessories

28080 Battery 2,0 Ah

28081 Battery 4,0 Ah

28085 Charger 2,4 A

28086 Charger 4,0 A



quick release saw blade



CORDLESS RECIPROCATING SAW



*battery not included

No. specifications

28055



4

SHARE
20V *Li-ion*
technology

28004
page 6

28032
page 12

28055
page 15

DISCOUNTED
PRICE
+FREE BAG

28035
page 14

37330

28040
page 13



FESTA
POWER X TOOLS

CORDLESS SET WITH BAG SET 5+3

- 28004 - Drill Cordless with a hammer FESTA SHARE20V
- 28032 - Angle grinder Cordless FESTA SHARE20V 115 mm
- 28035 - Circular saw Cordless FESTA SHARE20V 165 mm/d 16 mm
- 28040 - Eccentric grinder Cordless FESTA SHARE20V 125 mm 8 otv.
- 28055 - Hack saw Cordless FESTA SHARE20V
- 28080 - Battery for cordless tools FESTA SHARE20V 2,0 Ah
- 28081 - Battery for cordless tools FESTA SHARE20V 4,0 Ah
- 28086 - Charger FESTA SHARE20V 4,0 A

28080
page 18



28081
page 18



28086
page 18



No. specifications

28101



1

SHARE
20V *Li-ion*
technology

BRUSHLESS

28002
page 5

28030
page 12

DISCOUNTED
PRICE
+FREE BAG

28040
page 13

BRUSHLESS

28055
page 15

37330

28035
page 14

FESTA
POWER X TOOLS

CORDLESS SET WITH BAG SET 5+3

- 28002 - Drill Cordless with a hammer FESTA SHARE20V
- 28030 - Angle grinder Cordless FESTA "BRUSHLESS" SHARE20V 125 mm
- 28035 - Circular saw Cordless FESTA SHARE20V 165 mm/d 16 mm
- 28040 - Eccentric grinder Cordless FESTA SHARE20V 125 mm 8 otv.
- 28055 - Hack saw Cordless FESTA SHARE20V
- 28080 - Battery for cordless tools FESTA SHARE20V 2,0 Ah
- 28081 - Battery for cordless tools FESTA SHARE20V 4,0 Ah
- 28086 - Charger FESTA SHARE20V 4,0 A

28080
page 18



28081
page 18



28086
page 18



No. specifications

28104



1

SHARE
20V *Li-ion*
technology

DISCOUNTED
PRICE
+FREE BAG

28004
page 6



28030
page 12



BRUSHLESS

28025
page 9



37330



FESTA
POWER X TOOLS

CORDLESS SET WITH BAG SET 3+3

- 28004 - Drill Cordless with a hammer FESTA SHARE20V
- 28025 - Drilling hammer Cordless FESTA SDS+ SHARE20V
- 28030 - Angle grinder Cordless FESTA "BRUSHLESS" SHARE20V 125 mm
- 28080 - Battery for cordless tools FESTA SHARE20V 2,0 Ah
- 28081 - Battery for cordless tools FESTA SHARE20V 4,0 Ah
- 28086 - Charger FESTA SHARE20V 4,0 A

28080
page 18



28081
page 18



28086
page 18



No. specifications

28102



1

BRUSHLESS **SHARE**
20V *Li-ion*
technology

DISCOUNTED
PRICE
+FREE BAG

28030
page 12



37330



28002
page 5



FESTA
POWER X TOOLS

CORDLESS SET WITH BAG SET 2+3

- 28002 - Drill Cordless with a hammer FESTA SHARE20V
- 28030 - Angle grinder Cordless FESTA "BRUSHLESS" SHARE20V 125 mm
- 28080 - Battery for cordless tools FESTA SHARE20V 2,0 Ah
- 28081 - Battery for cordless tools FESTA SHARE20V 4,0 Ah
- 28086 - Charger FESTA SHARE20V 4,0 A

28080
page 18



28081
page 18



28086
page 18



No. specifications

28103



1

SHARE
20V



CHARGER 20 V | 24 A

No.	specifications	
28085	220 – 240 V, 50 – 60 Hz, 70 W	20

SHARE
20V



CHARGER 20 V | 4,0 A

No.	specifications	
28086	*220 – 240 V, 50 – 60 Hz, 105 W	20

SHARE
20V *Li-ion technology*



battery charge indicator



BATTERY 20 V | 2,0 Ah

20V	2,0 Ah	Li-ion	KG 0,4
-----	--------	--------	--------

No.	specifications	
28080		20

SHARE
20V *Li-ion technology*



battery charge indicator



BATTERY 20 V | 4,0 Ah

20V	4,0 Ah	Li-ion	KG 0,7
-----	--------	--------	--------

No.	specifications	
28081		20

BRUSHLESS

the tool is powered
brushless DC motor

torque	
speed	
selectable direction of rotation	
chuck	
drilling, hammer drilling, screwing	
number of strokes per minute	
drilling, screwdriving	
mass with / without battery	
method of attachment	
method of attachment	
method of attachment	
disk eccentricity	
control of the device for right and left hand	
meets that standard	
luminous flux	
directional angle of light	
maximum firing frequency	

**SHARE
20V**

the tool is compatible
with both Battery

	suitable types of nails
	suitable types of buckles
	grinding wheel with holes
	maximum wheel diameter
	wheel diameter
	maximum cutting thickness material: wood
	maximum cutting thickness material: steel
	pre-oscillation setting
	saw attachment
	number of blade strokes
	possibility of beveled cut
	quick release of the saw blade
	number of saw oscillations
	LED lighting
	battery capacity
	battery
	charging time battery

TECHNICAL SPECIFICATIONS



PRODUCT CATALOG NUMBER	28000	28001	28002	28003	28004
Name	Hammer drill cordless	Hammer drill cordless	Hammer drill cordless	Hammer drill cordless	Hammer drill cordless
Speed without load	I.0-550 min ⁻¹ II.0-2000 min ⁻¹	I.0-550 min ⁻¹ II.0-2000 min ⁻¹	I.0-550 min ⁻¹ II.0-2000 min ⁻¹	I.0-500 min ⁻¹ II.0-1800 min ⁻¹	I.0-500 min ⁻¹ II.0-1800 min ⁻¹
Number of hits	I.0-8800min ⁻¹ II.0-32000min ⁻¹	I.0-8800min ⁻¹ II.0-32000min ⁻¹	I.0-8800min ⁻¹ II.0-32000min ⁻¹	0-19200 min ⁻¹	0-19200 min ⁻¹
Number of strokes					
Torque	80 Nm	80 Nm	80 Nm	45 Nm	45 Nm
Max. battery voltage	20V	20V	20V	20V	20V
Number of torque stages	20+1+1	20+1+1	20+1+1	19+1+1	19+1+1
Clamping head	2-13 mm	2-13 mm	2-13 mm	2-13 mm	2-13 mm
Weight without battery	1,4kg	1,4kg	1,4kg	1,3kg	1,3kg
Cover	IPX0	IPX0	IPX0	IPX0	IPX0
Sound pressure level uncertainty K	LpA=97,04dB(A) K=5dB(A)	LpA=97,04dB(A) K=5dB(A)	LpA=97,04dB(A) K=5dB(A)	LpA=79dB(A) K=5dB(A)	LpA=79dB(A) K=5dB(A)
Sound power level uncertainty K	LwA=86,04dB(A) K=5dB(A)	LwA=86,04dB(A) K=5dB(A)	LwA=86,04dB(A) K=5dB(A)	LwA=90dB(A) K=5dB(A)	LwA=90dB(A) K=5dB(A)
Vibration without hammering into the metal	$\alpha_{h,D}=3,9m/s^2$ K=1,5m/s ²	$\alpha_{h,D}=3,9m/s^2$ K=1,5m/s ²	$\alpha_{h,D}=3,9m/s^2$ K=1,5m/s ²	$\alpha_{h,D}=2,4m/s^2$ K=1,5m/s ²	$\alpha_{h,D}=2,4m/s^2$ K=1,5m/s ²
Vibration without hammering into concrete	$\alpha_{h,ID}=11,4m/s^2$ K=1,5m/s ²	$\alpha_{h,ID}=11,4m/s^2$ K=1,5m/s ²	$\alpha_{h,ID}=11,4m/s^2$ K=1,5m/s ²	$\alpha_{h,ID}=7,5m/s^2$ K=1,5m/s ²	$\alpha_{h,ID}=7,5m/s^2$ K=1,5m/s ²
Maximum vibration, uncertainty K					
Strike force					
Drilling diameter					
Vibration into the concrete -main handle					
Vibration in concrete - additional handle					
Package contents	drill, 2.4 A charger, battery 2.0 Ah, 4.0 Ah battery, additional handle, suitcase	drill, charger 2.4 A, battery 2.0 Ah, additional handle, suitcase	drill	drill, 2.4 A charger, 2x 2.0 Ah battery, 6x bit, carrier, 6x drill, suitcase	drill



28005	28006	28007	28008	28021	28025
Drill cordless screwdriver	Drill cordless screwdriver	Drill cordless screwdriver	Cordless screwdriver	Cordless impact wrench	Cordless hammer drill
1.0-350 min ⁻¹ 11.0-1300 min ⁻¹	1.0-350 min ⁻¹ 11.0-1300 min ⁻¹	1.0-350 min ⁻¹ 11.0-1300 min ⁻¹	200 min ⁻¹	0-2000 min ⁻¹	1.0-300 min ⁻¹ 11.0-1000 min ⁻¹
					0-5000bpm
				0-3000bpm	
28 Nm	28 Nm	20 Nm	3 Nm	150 Nm	
20V	20V	12V	3.6V	20V	20V
19+1	19+1	19+1	6+1		
1-10mm	1-10mm	1-10mm	1/4" hexagon	1/4" hexagon	SDS+
0,9kg	0,9kg	*1kg	*0,4kg	1,2kg	1,7kg
IPX0	IPX0	IPX0	IPX0	IPX0	IPX0
LpA=69dB(A) K=5dB(A)	LpA=69dB(A) K=5dB(A)	LpA=78dB(A) K=5dB(A)	LpA=58dB(A) K=3dB(A)	LpA=92dB(A) K=3dB(A)	LpA=82,98dB(A) K=3dB(A)
LwA=80dB(A) K=5dB(A)	LwA=80dB(A) K=5dB(A)	LwA=67dB(A) K=5dB(A)	LwA=69dB(A) K=3dB(A)	LwA=103dB(A) K=3dB(A)	LwA=93,98dB(A) K=3dB(A)
$\alpha_{h,D} < 1,9m/s^2$ K=1,5m/s ²	$\alpha_{h,D} < 1,9m/s^2$ K=1,5m/s ²	$\alpha_{h,D} = 2,1m/s^2$ K=1,5m/s ²			
$\alpha_{h,D} = 10,1m/s^2$ K=1,5m/s ²	$\alpha_{h,D} = 10,1m/s^2$ K=1,5m/s ²	$\alpha_{h,D} = 7,5m/s^2$ K=1,5m/s ²			
			$\alpha_h < 2,5m/s^2$ K=1,5m/s ²	$\alpha_{h,D} = 15,9m/s^2$ K=1,5m/s ²	
					1,2J
					Steel: 10mm concrete: 20mm Wood: 20mm
					$\alpha_{h,(HD)} = 5,582m/s^2$ K=1,5m/s ²
					$\alpha_{h,(HD)} = 5,523m/s^2$ K=1,5m/s ²
drill, 2.4 A charger, 2x 2.0 Ah battery, 6x bit, carrier, 6x drill, suitcase	drill	drill, 2.4 A charger, 2x 1.5 Ah Battery, 6x bits, carrier, 6x drill, suitcase	screwdriver, charger 0.5 A, 1.5 Ah battery, 5x bit	tightener	drilling hammer, additional handle, depth stop

* weight is stated including battery

TECHNICAL SPECIFICATIONS



PRODUCT CATALOG NUMBER	28030	28032	28035	28040
Name	Cordless angle grinder	Cordless angle grinder	Cordless circular saw	Battery orbital sander
No-load speed	8500 min ⁻¹	8000 min ⁻¹	3650 min ⁻¹	10.000 min ⁻¹
Number of oscillations without load				
Forward				
Number of pre-oscillation degrees				
Number of blades of the saw blade				
Maximum cut profile				
Maximum wheel diameter	125 mm	115 mm		
Support disc				125 mm
8 suction holes on the circle				65 mm
Eccentricity of the wheel				5 mm
Spindle thread size	M14	M14		
Maximum thickness of cut material	15 mm	15 mm		
Max. battery voltage	20V	20V	20V	20V
Adjustable cutting angle			0-45°	
Cut at an angle of 45 °			35 mm	
Cut at an angle of 90 °			50 mm	
Oscillation angle				
Dimension of delta grinding Base				
Vibration speed control				
Attaching the saw blade				
Stroke of the saw blade				
Base plate size			28 cm x 13,3 cm	
Weight without battery	1,6kg	1,6kg	2,7kg	1kg
Wheel diameter			165 mm	
Wheel body thickness			1,4 mm ± 5% mm	
Thickness SK of the blade blade			2,0 ± 5% mm	
Cutting width			2,3 ± 5% mm	
Diameter of the wheel hole after clamping			16 mm	
Number of disc teeth			24	
Cover	IPX0	IPX0	IPX0	IPX0
Nails-type, height x width x thickness				
Buckles-span x height x width x thickness				
Max. length of nails / clips into soft mats.				
Max. length of nails / clips into hard matt.				
Average / max. shooting frequency				
Operating time (4 AH battery, fully charged)				
Nail / staple magazine capacity				
Sound pressure level uncertainty K	LpA=87,1dB(A) K=3dB(A)	LpA=76,67dB(A) K=3dB(A)	LpA=84dB(A) K=3dB(A)	LpA=76dB(A) K=3dB(A)
Sound power level uncertainty K	LwA=98,1dB(A) K=3dB(A)	LwA=87,67dB(A) K=3dB(A)	LwA=95dB(A) K=3dB(A)	LwA=87dB(A) K=3dB(A)
Vibration when grinding the surface	$\alpha_{h,AG}=8,363m/s^2$ K=1,5m/s ²	$\alpha_{h,AG}=5,324m/s^2$ K=1,5m/s ²		
Vibration for cutting the board				
Vibration for sheet metal cutting				
Vibration for cutting Wood:en frames				
Maximum vibration, uncertainty K			$\alpha_h < 2,5m/s^2$ K=1,5m/s ²	$\alpha_h = 9,5m/s^2$ K=1,5m/s ²
Package contents	grinder, wheel cover, additional handle, wrench	grinder, wheel cover, additional handle, wrench	saw, depth stop, saw blade	grinder, dust collection bag



28045	28050	28055	28070
Cordless device multi-functional	Cordless jigsaw	Cordless reciprocating saw	Cordless nailer and stapler
5000-15000 min ⁻¹		0-3000 min ⁻¹	
	3+0	1°	
	0-2400 min ⁻¹		
	Steel: 6mm, Wood: 80mm	Wood: 100 mm, Steel: 5 mm, aluminum / copper: 20 mm	
20V		20V	20V
	bevel cut max. 45 °		
3°			
90 mm			
YES			
universal		universal	
		20 mm	
1kg	1,8kg	1,7kg	2,7kg
IPX0	IPX0	IPX0	IPX0
			F, 20-50mm x 1,2mm x 1,0 mm
			6,0mm x 19-40mm x 1,2mm x 1,0mm
			50 mm
			30 mm
			60/100 min ⁻¹
			1 hour
			100 pieces
LpA=78dB(A) K=3dB(A)	LpA=88,1dB(A) K=5dB(A)	LpA=87,33dB(A) K=5dB(A)	LpA=79,9dB(A) K=3dB(A)
LwA=89dB(A) K=3dB(A)	LwA=99,1dB(A) K=5dB(A)	LwA=98,33dB(A) K=5dB(A)	LwA=90,9dB(A) K=3dB(A)
	$\alpha_{h,B}=3,3m/s^2$ $K=1,5m/s^2$ $\alpha_{h,M}=4m/s^2$ $K=1,5m/s^2$	$\alpha_{h,B}=21,10m/s^2$ $K=1,5m/s^2$	
		$\alpha_{h,WB}=21,98m/s^2$ $K=1,5m/s^2$	
$\alpha_h=2,8m/s^2$ $K=1,5m/s^2$			$\alpha_h=1,39m/s^2$ $K=1,5m/s^2$
grinder, attachments (saw, scraper, carrier), 3x sandpaper P80	saw, guide rail, suction attachment, 2x saw blade	saw, 2x saw blade	nailer / stapler, 200x nails, 200x staples



MEASURING TOOLS

24 - 57



26

MEASURING TAPE
KOMELON



28

MEASURING TAPE FESTA



31

LONG MEASURING TAPE



32

FOLDING RULE



34

WORKSHOP CALIPER



35

RULES AND SQUARES



38

SPIRIT AND SCREEDING
LEVELS HORIZONT



43

SPIRIT LEVEL NIVELA



45

DIGITAL LEVEL AND
SQUARE



46

LASER MEASURING
DEVICE



50

PENCILS AND MARKERS



56

SPRAYERS



· HIGHLY PRECIOUS AND QUALITY MEASUREMENTS

KOMELON®

- II. class accuracy reg. ČSN 251104, EEC 755345
- nylon coating of the blade DURA NY Coat™ guarantees 10x higher resistant of the measuring blade

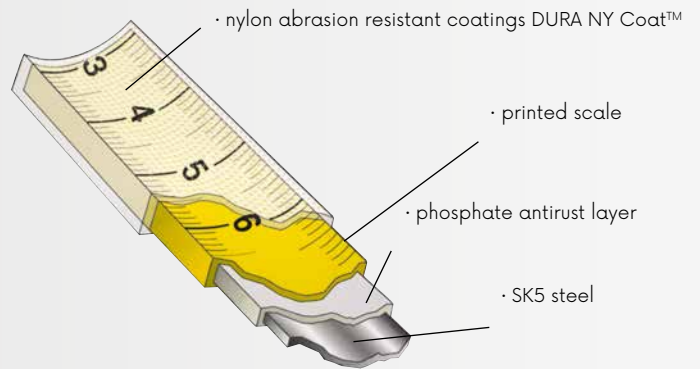

KOMELON® MEASURING TAPE

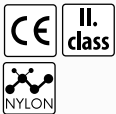

No.	specification	
10002	2 m · 16 mm	10
10003	3 m · 16 mm	10
10005	5 m · 19 mm	10
10008	8 m · 25 mm	10

KOMELON® MEASURING TAPE

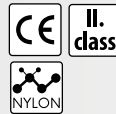

No.	specification	
10025	5 m · 25 mm	10

KOMELON® MEASURING TAPE

- automatic break
- anti-slip rubber coating

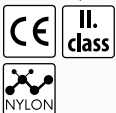

No.	specification	
10033	3 m · 16 mm	6
10035	5 m · 19 mm	6

KOMELON® MEASURING TAPE



No.	specification	
10043	3 m · 16 mm	30
10045	5 m · 19 mm	30
10048	8 m · 25 mm	12

KOMELON®
LONG STEEL TAPE



No.	specification	
10110	10 m · 10 mm	6
10120	20 m · 10 mm	6
10130	30 m · 10 mm	6

KOMELON®
FIBERGLASS TAPE

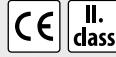

No.	specification	
10330	10 m · 13 mm	6
10332	20 m · 13 mm	6
10334	30 m · 13 mm	6
10336	50 m · 13 mm	6

KOMELON®
FIBERGLASS TAPE



No.	specification	
10430	30 m · 13 mm	1
10450	50 m · 13 mm	1
10490	100 m · 13 mm	1

KOMELON®
PROMOTIONAL STAND

· items in stand 10996



- 10003 · 5 pcs
- 10005 · 4 pcs
- 10008 · 1 pcs
- 10033 · 2 pcs
- 10035 · 3 pcs
- 10045 · 2 pcs
- 10025 · 3 pcs
- 10110 · 1 pcs
- 10120 · 1 pcs
- 10130 · 1 pcs
- 10430 · 1 pcs
- 10330 · 1 pcs
- 10332 · 1 pcs
- 10334 · 1 pcs
- 10336 · 1 pcs

· illustration photo

No.	specification	
10999	promotional stand for measuring tapes	1
10996	stand filled with items	1



· Information about the tape



- A** · length of tape
- B** · accuracy class
- C** · declaration of conformity - CE
- D** · year of manufacture
- E** · the number of the accredited certification office issuing the certificate
- F** · producer
- G** · special tape adjustment
- H** · the temperature at which the test was performed

PROMOTIONAL STAND



· illustration photo

No.	specification	
10998		1

FESTA[®]



FESTA[®]

MEASURING TAPE

- scale with big numerals
- anti-slip rubber coating
- nylon coat



No.	specification	
11353	3 m · 19 mm	12
11355	5 m · 19 mm	12
11356	5 m · 25 mm	12
11358	8 m · 25 mm	6
11360	10 m · 25 mm	6



FESTA[®]

MEASURING TAPE



No.	specification	
11343	3 m · 16 mm	6
11345	5 m · 19 mm	6
11347	7,5 m · 25 mm	6



FESTA[®]

MEASURING TAPE - MAGNET

- 3 x break
- magnetic hook
- lock up
- anti-slip rubber coating



No.	specification	
11323	3 m · 16 mm	10
11325	5 m · 19 mm	10
11327	7,5 m · 25 mm	6



FESTA[®]

MEASURING TAPE COMPACT

- small size of measuring tape
- nylon coat



No.	specification	
11220	3 m · 16 mm	12
11221	5 m · 19 mm	12



FESTA[®]

MEASURING TAPE

- scale with big numerals



No.	specification	
11226	2 m · 16 mm	10
11239	3 m · 19 mm	10
11259	5 m · 19 mm	10
11260	7,5 m · 25 mm	10

FESTA

MEASURING TAPE MAGNETIC

- magnetic hook
- anti-slip rubber coating
- fluorescent tape
- scale with big numerals



No.	specification	
11102	2 m · 16 mm	10
11103	3 m · 16 mm	10
11105	5 m · 19 mm	12
11106	5 m · 25 mm	12
11107	7,5 m · 25 mm	10
11110	10 m · 25 mm	6



FESTA

MEASURING TAPE

- automatic break
- anti-slip rubber coating



No.	specification	
11333	3 m · 16 mm	12
11335	5 m · 19 mm	12
11337	7,5 m · 25 mm	12
11338	10 m · 25 mm	12



Johnney

MEASURING TAPE

- matt adjustment of tape



No.	specification	
11002	2 m · 13 mm	12
11003	3 m · 13 mm	12
11005	5 m · 13 mm	12
11006	5 m · 19 mm	12
11007	7,5 m · 19 mm	12
11008	10 m · 25 mm	12



MEASURING TAPE - ERGO

- lock up
- anti-slip rubber coating



No.	specification	
11082	2 m · 16 mm	12
11083	3 m · 16 mm	12
11085	5 m · 19 mm	12



MEASURING TAPE

- metric and inch scale
- anti-slip rubber coating



No.	specification	
11416	5 m · 19 mm	10

MEASURING TAPE

- lock up



No.	specification	
11200	2 m · 13 mm	24
11201	2 m · 16 mm	24
11202	2 m · 19 mm	24
11204	3 m · 13 mm	24
11205	3 m · 16 mm	24
11206	3 m · 19 mm	24
11207	5 m · 19 mm	12
11208	5 m · 25 mm	12
11209	7,5 m · 25 mm	12
11210	10 m · 25 mm	12



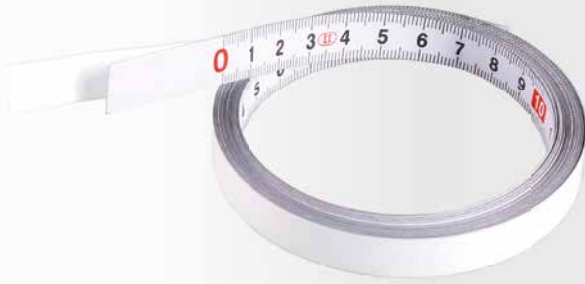

FLAT SELF ADHESIVE METAL MEASURING TAPE

II. class



No.	specification	
11311	1 m · 12,5 mm	30
11312	2 m · 12,5 mm	30
11313	3 m · 16 mm	30
11314	5 m · 19 mm	30

MEASURING TAPE WITH PRINTED NAME, 3M · 16 MM

CE II. class



No.	name	No.	name	No.	name
13500	JIRÍ	13512	MICHAL	13524	ROMAN
13501	PETR	13513	MILAN	13525	ŠIKULA
13502	JOSEF	13514	KAREL	13526	RADEK
13503	TOMÁŠ	13515	VLADIMÍR	13527	MISTR
13504	JAN	13516	DĚDEČEK	13528	ONDŘEJ
13505	MARTIN	13517	MŮJ METR	13529	MAREK
13506	JAROSLAV	13518	VÁCLAV	13530	STANISLAV
13507	FRANTIŠEK	13519	JAKUB	13531	BOREC
13508	PAVEL	13520	LUKÁŠ	13532	TATÍNEK
13509	MIROSLAV	13521	2X MĚŘ	13533	ANTONÍN
13510	BIG BOSS	13522	LADISLAV	13534	ALEŠ
13511	ZDENĚK	13523	DAVID		



FESTA

MEASURING TAPE - KEYCHAIN

- scale with big numerals
- properties of classical measuring tape

II. class

MOQ 12

No.	specification	
11410	2 m · 16 mm 6 colour	12

MEASURING TAPE - KEYCHAIN

No.	specification	
11420	1 m · 6 mm orange	24



MEASURING TAPE KEYCHAIN

No.	specification	
11444	1 m · 6 mm white	20

MEASURING TAPE KEYCHAIN

No.	specification	
11425	1 m · 6 mm	25

LIBELA - KEYCHAIN

No.	specification	
11445		100



FESTA

LONG STEEL TAPE

· loop



No.	specification	
12010	10 m · 10 mm	1
12020	20 m · 10 mm	1
12030	30 m · 10 mm	1
12050	50 m · 10 mm	6



FESTA

FIBERGLASS TAPE

· loop



No.	specification	
12110	10 m · 13 mm	6
12120	20 m · 13 mm	1
12130	30 m · 13 mm	1
12150	50 m · 13 mm	1



FESTA

LONG STEEL TAPE

· loop + hook



No.	specification	
12210	10 m · 10 mm	6
12220	20 m · 10 mm	6
12230	30 m · 10 mm	6
12250	50 m · 10 mm	6



FESTA

LONG STEEL TAPE

· loop



No.	specification	
12433	30 m · 12,5 mm	20
12435	50 m · 12,5 mm	10



MEASURING WHEEL

- resistant, light and compact
- counter attribute when moving forward and subtract when moving back
- built-in lighting - 2 x AAA batteries in handle
- with bag



No.	specification	
15989	max. 10 km	2



FESTA

TELESCOPIC MEASURING POLE

· with bag

No.	specification	
15983	0,7 - 3 m	10
15985	1,1 - 5 m	10
15988	1,6 - 8 m	5

FOLDING RULE

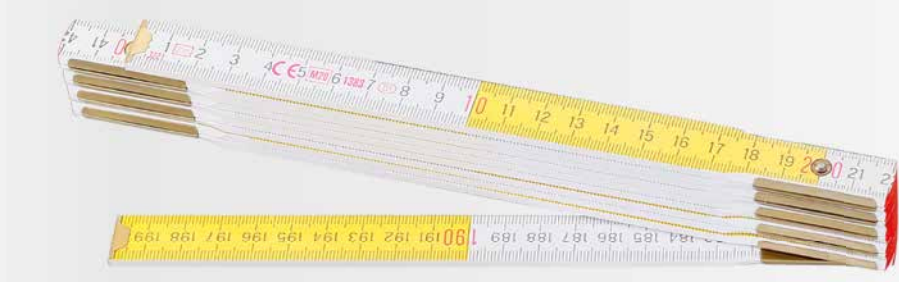
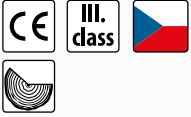

No.	specification	
13010	1 m · white	20
13020	2 m · white	10
13021	1 m · yellow	20
13022	2 m · yellow	10
13023	2 m · white - yellow	10

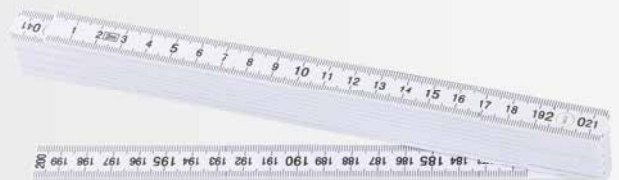
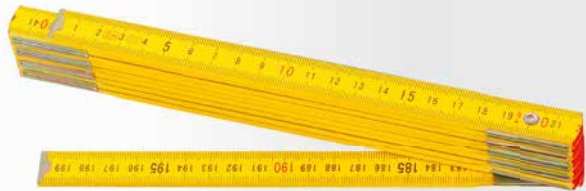

FOLDING RULE



No.	specification	
13111	1 m · yellow	10
13120	2 m · yellow	5

FOLDING RULE



No.	specification	
13210	1 m · mini	10
13211	1 m	1
13220	2 m	1



FOLDING RULE WITH NAME



No.	name	No.	name	No.	name
13401	JIŘÍ	13426	DANIEL	13451	JANA
13402	JAN	13427	ANTONÍN	13452	EVA
13403	PETR	13428	VOJTĚCH	13453	PETRA
13404	JOSEF	13429	FILIP	13454	MAJKA
13405	PAVEL	13430	ADAM	13455	HANA
13406	MARTIN	13431	MILOSLAV	13456	ANNA
13407	JAROSLAV	13432	MATĚJ	13457	LENKA
13408	TOMÁŠ	13433	ALEŠ	13458	KATKA
13409	MIROSLAV	13434	JAROMÍR	13459	LUCIE
13410	ZDENĚK	13435	LIBOR	13460	ALENA
13411	FRANTIŠEK	13436	DOMINIK	13461	VERONIKA
13412	VÁCLAV	13437	PATRIK	13462	MARTINA
13413	MICHAL	13438	VLASTIMIL	13463	JITKA
13414	MILAN	13439	JINDŘICH	13464	BIG BOSS
13415	KAREL	13440	MILOŠ	13465	2 x MĚŘ
13416	JAKUB	13441	JÁN	13466	TATÍNEK
13417	DAVID	13442	PETER	13467	DĚDEČEK
13418	LUKÁŠ	13443	ONDREJ	13468	ŠIKULA
13419	VLADIMÍR	13444	JOZEF	13469	MISTR
13420	LADISLAV	13445	PAVOL	13470	MACHR
13421	ONDŘEJ	13446	L'UBOMÍR	13471	BOREC
13422	ROMAN	13447	KAROL	13472	UŽ JE MŮJ
13423	STANISLAV	13448	RADOSLAV	13473	MŮJ METR
13424	MAREK	13449	VOJTĚCH		
13425	RADEK	13450	ZDENKO		



FESTA

WORKSHOP CALIPER DIGITAL

INOX



No.	specification	
14007	150 0,01 mm	10
14008	200 0,01 mm	10
14009	300 0,01 mm	10



WORKSHOP CALIPER DIGITAL FIBERGLASS

· accuracy 0.2 mm, resolution 0.1 mm

No.	specification	
14013	150 0,2 mm	10



FESTA

WORKSHOP CALIPER

INOX



No.	specification	
14001	150 0,02 mm	10
14002	200 0,02 mm	10
14003	300 0,02 mm	10

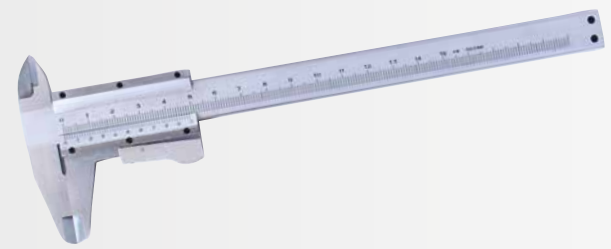

FESTA

WORKSHOP CALIPER

INOX



No.	specification	
14004	150 0,02 mm	10



FESTA

OUTSIDE MIKROMETER

No.	specification	
14040	0 - 0,25 0,01 mm	10
14045	25 - 50 0,01 mm	10



WORKSHOP CALIPER

HOBBY



No.	specification	
14006	150 mm	50



FESTA

DIAL INDICATOR

INOX



No.	specification	
14035	0 - 10mm 0,01 mm	10



FEELER GAGES

· 20 leaves

No.	specification	
14080	0,05 - 1 mm	10



FESTA

PROTRACTOR

· with case

INOX

No.	specification	
14060	0° - 180° · 150 x 200 mm	5
14070	0° - 180° · 300 x 500 mm	7

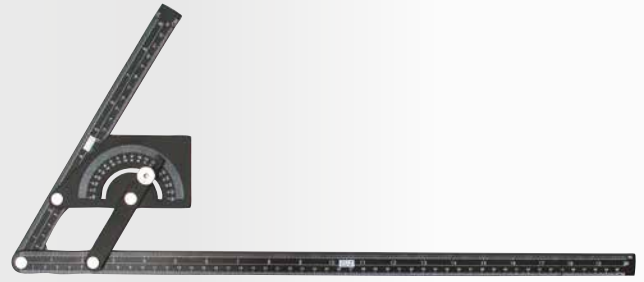

PROTRACTOR

HOBBY

No.	specification	
14075	0° - 180° · 230 x 500 mm	30

NEW



MULTIPURPOSE FOLDING RULER



No.	Specification	
14077		1



MULTIPURPOSE RULE

PLASTIC

No.	specification	
14480	250 x 120 mm	1



CONTOUR DUPLICATOR TEMPLATE

PLASTIC

No.	specification	
14090	125 x 30 mm	1
14091	250 x 30 mm	1



FESTA
MULTIFUNCTION
SQUARE

ALU

No.	specification	
14420	180 mm	10
14421	300 mm	10

NEW

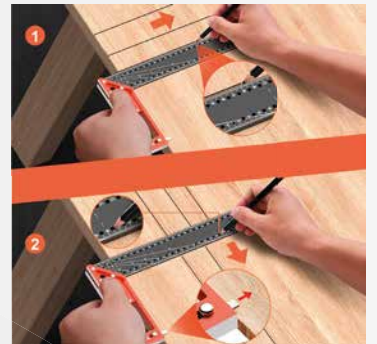
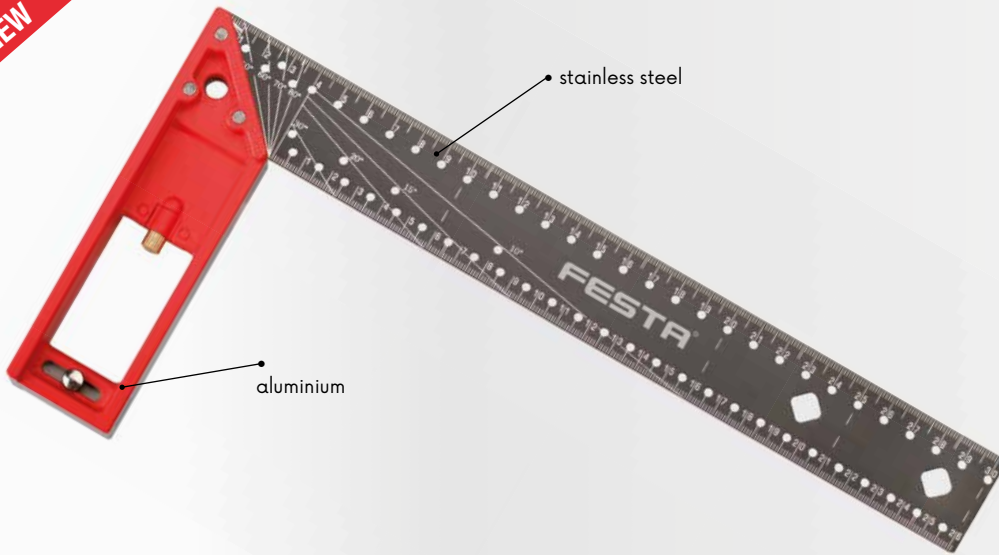

FESTA
MULTIFUNCTION SQUARE

INOX ALU

No.	Specification	
14415	300 mm	6
14417	400 mm	6



FESTA
SQUARE

MADE IN EU

No.	specification	
14220	200 x 125 mm	10
14225	250 x 135 mm	10
14230	300 x 135 mm	10



FESTA
SQUARE

MADE IN EU

No.	specification	
14350	500 x 235 mm	10
14360	600 x 300 mm	10
14370	700 x 300 mm	10

No.	specification	
14380	800 x 320 mm	10
14399	1000 x 360 mm	10



FESTA
SQUARE

ALU



No.	specification	
14450	190 x 355 mm	6
14451	200 x 405 mm	6

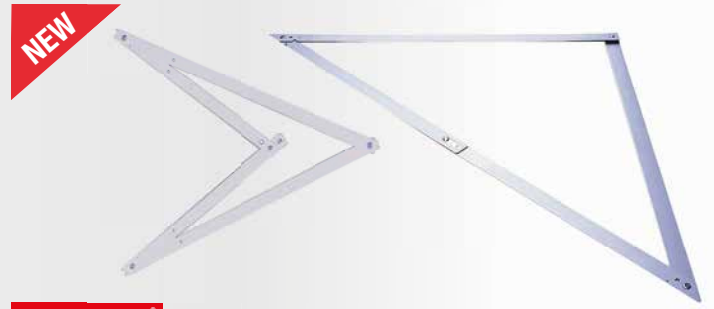

FESTA
SQUARE - FOLDABLE

ALU

No.	specification	
14445	600 x 600 mm	1
14446	1200 x 1200 mm	1



SQUARE

No.	specification	
14410	300 x 200 mm	50
14411	600 x 400 mm	36

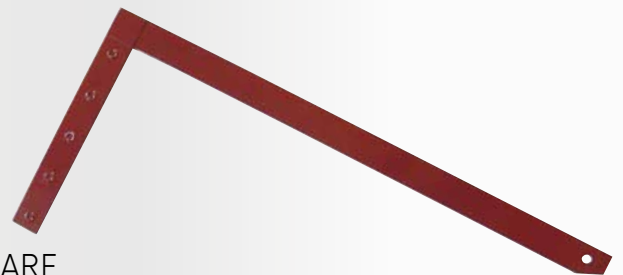

SQUARE

No.	specification		No.	specification	
14455	300 x 200 mm	50	14457	700 x 300 mm	40
14456	500 x 250 mm	50	14458	1000 x 450 mm	30



SQUARE FLAT

Zn

No.	specification	
14471	150 x 100 mm	25
14472	250 x 125 mm	25
14473	400 x 200 mm	30
14474	600 x 300 mm	25



SQUARE

Zn

No.	specification	
14490	100 x 50 mm	10
14491	150 x 75 mm	10
14492	250 x 125 mm	10
14493	400 x 200 mm	10
14494	600 x 300 mm	10



TRY SQUARE

ALU

HOBBY

No.	specification	
14425	250 x 130 mm	12
14430	300 x 130 mm	12
14435	350 x 156 mm	12
14440	400 x 156 mm	12

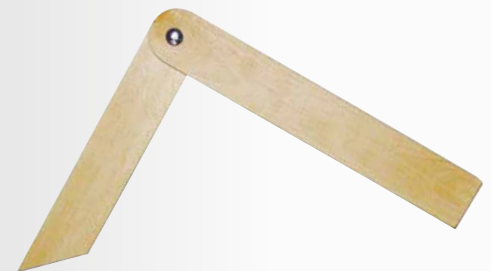

BEVEL SQUARE WOODEN

MADE IN EU



No.	specification	
14025	255 x 285 mm	1

HORIZONT[®] EXACTA

Precise levels
with highest measuring accuracy

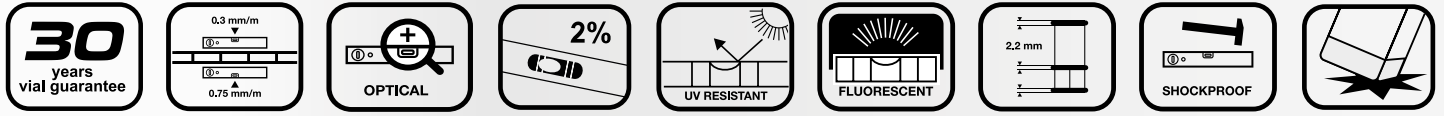

Every piece is electronically tested and has its evidence number, the producer is the holder of certificate ISO 90001



HORIZONT
LEVEL EXACTA, 2 VIALS

ALU		
No.	specification	
15033	60 cm	10



HORIZONT
LEVEL EXACTA, 3 VIALS

ALU		
No.	specification	
15034	80 cm	10
15035	100 cm	10



HORIZONT
LEVEL EXACTA, 3 VIALS, 2 HANDLES

ALU		
No.	specification	
15036	120 cm	10
15037	150 cm	10
15039	200 cm	10

HORIZONT®

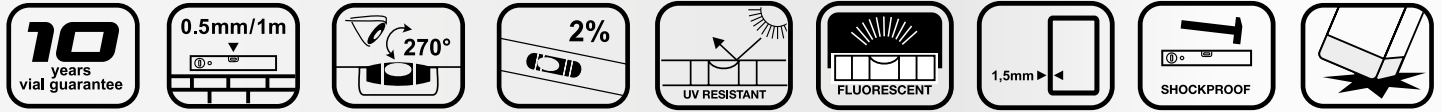

Every piece is electronically tested and has its evidence number, the producer is the holder of certificate ISO 9001



HORIZONT® LEVEL, 2 VIALS



No.	specification	
15003	30 cm	30
15004	40 cm	30
15005	50 cm	30
15006	60 cm	30
15008	80 cm	30
15010	100 cm	30
15012	120 cm	10
15015	150 cm	10
15018	180 cm	10
15020	200 cm	10



HORIZONT® LEVEL, 3 VIALS



No.	specification	
15103	30 cm	30
15104	40 cm	30
15105	50 cm	30
15106	60 cm	30
15108	80 cm	30
15110	100 cm	30
15112	120 cm	10
15115	150 cm	10
15118	180 cm	10
15120	200 cm	10



HORIZONT.
LEVEL, 2 VIALS + MAGNET



No.	specification	
15204	40 cm	30
15205	50 cm	30
15206	60 cm	30
15208	80 cm	30
15210	100 cm	30
15212	120 cm	10
15215	150 cm	10
15218	180 cm	10
15220	200 cm	10



HORIZONT.
GRADIENT LEVEL, 4 VIALS



No.	specification	
15230	80 cm	10



HORIZONT.
GRADIENT LEVEL, 1 VIAL



No.	specification	
15235	60 cm	1



HORIZONT.
MASON STAFF



No.	specification	
15310	100 cm	10
15315	150 cm	10
15318	180 cm	10
15320	200 cm	10
15325	250 cm	10
15330	300 cm	10
15335	350 cm	10
15340	400 cm	10



HORIZONT
MASON STAFF, 1 VIAL

ALU

No.	specification	
15415	150 cm	10
15418	180 cm	10
15420	200 cm	10
15425	250 cm	10
15430	300 cm	10



HORIZONT
MASON STAFF, 2 VIALS

ALU

No.	specification	
15510	100 cm	10
15515	150 cm	10
15518	180 cm	10
15520	200 cm	10
15525	250 cm	10
15530	300 cm	10
15535	350 cm	10
15540	400 cm	5

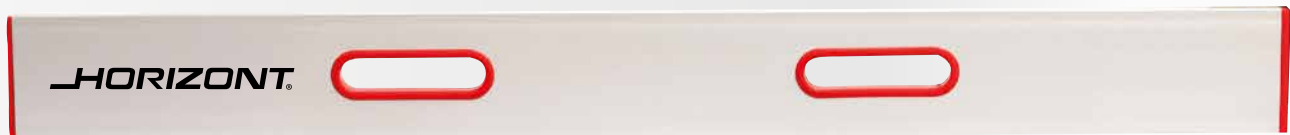

HORIZONT
MASON STAFF, 2 HANDLES, WITHOUT VIALS

ALU

No.	specification	
15615	150 cm	10
15620	200 cm	10
15625	250 cm	10
15630	300 cm	10



HORIZONT
MASON STAFF, 2 VIALS, 2 HANDLES

ALU

No.	specification	
15710	100 cm	10
15715	150 cm	10
15720	200 cm	10
15725	250 cm	10
15730	300 cm	10
15735	350 cm	10
15740	400 cm	5

NEW

HORIZONT.
SQUARE

ALU

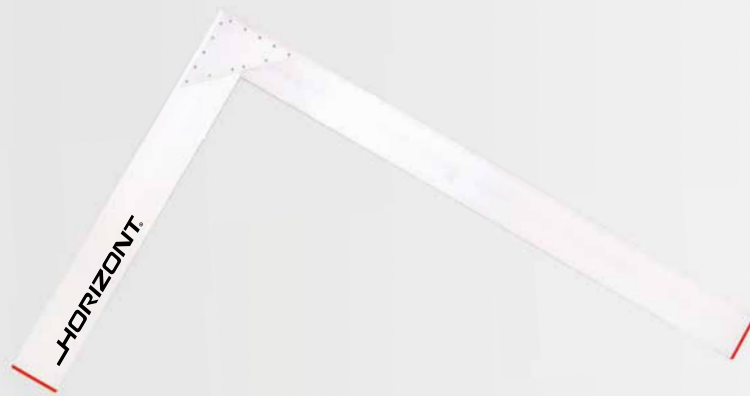

No.	specification	
14485	800 x 1200 mm	1
14486	1000 x 1500 mm	1



HORIZONT.
MASON STAFF, TRAPEZ

PROFILE TRAPEZOIDAL
 · trapezoidal profile for finer surface finishes
 · suitable for stuccoers and facades
 · suitable for thin-film plasters

ALU

No.	specification	
15810	100 cm	10
15812	120 cm	10
15815	150 cm	10
15818	180 cm	10
15820	200 cm	10
15825	250 cm	10
15830	300 cm	10



HORIZONT.
MASON STAFF, "h" PROFIL

PROFILE "h"
 · "h" profile for finer surface finishes
 · suitable for stuccoers and facades
 · suitable for stucco plastering

ALU

No.	specification	
15850	100 cm	10
15853	150 cm	10
15855	180 cm	10
15860	200 cm	10
15870	250 cm	10
15880	300 cm	10

HORIZONT.
STAND FOR LEVEL HORIZONT

· items in stand 15998

- 15003 · 5 pcs
- 15004 · 5 pcs
- 15005 · 5 pcs
- 15006 · 5 pcs
- 15008 · 5 pcs
- 15010 · 5 pcs
- 15012 · 5 pcs
- 15015 · 3 pcs
- 15018 · 3 pcs
- 15020 · 3 pcs
- 15108 · 3 pcs
- 15206 · 3 pcs
- 15210 · 3 pcs

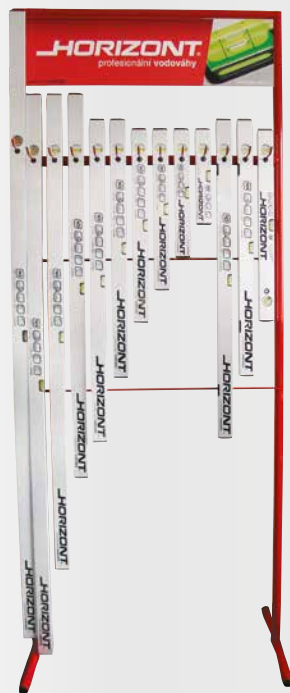

No.	specification	
15999	85 x 210 x 50 cm	1
15998	85 x 210 x 50 cm filled with items	1

HORIZONT.
STAND FOR LEVEL AND MASONRY STAFF HORIZONT

· items in stand 15996

- 15004 · 5 pcs
- 15005 · 5 pcs
- 15006 · 5 pcs
- 15008 · 5 pcs
- 15010 · 5 pcs
- 15012 · 5 pcs
- 15015 · 5 pcs
- 15018 · 5 pcs
- 15020 · 5 pcs
- 15315 · 2 pcs
- 15320 · 2 pcs
- 15325 · 3 pcs
- 15515 · 2 pcs
- 15520 · 2 pcs
- 15525 · 3 pcs



No.	specification	
15997	55 x 75 x 40 cm	1
15996	55 x 75 x 40 cm filled with items	1

- Accuracy 0,5 mm | 1 m (in the basic position)
- UV stable vials
- Shockproof rubber ends
- Profile thickness 2,4 mm



NIVELA

NIVELA LEVEL - 2 VIALS

• rubber ending



No.	specification	
15904	40 cm	30
15906	60 cm	30
15908	80 cm	30
15910	100 cm	30
15912	120 cm	20
15915	150 cm	10
15920	200 cm	20



NIVELA LEVEL - 3 VIALS



No.	specification	
15954	40 cm	60
15956	60 cm	60
15958	80 cm	60
15960	100 cm	30
15962	120 cm	30
15965	150 cm	30
15970	200 cm	30



DIGITAL LEVEL

- accuracy 0,5 mm /m,
- resolution 0,1°
- HOLD function for measured value storing
- profile 1,8 mm



No.	specification	
26215	600 mm	1



LEVEL TO HANG ON TWINE

PLASTIC LEVEL, 3 VIALS+MAGNET



No.	specification	
15981		1



No.	specification	
15980	230 mm	1



SPIRIT LEVEL FOR POLES

- 3 vials, magnets, fastening belt



No.	specification	
26028		12



GLASSPIPES WITH HOSE



No.	specification	
15992	glass pipes - hose 10 m	1
15993	glass pipes - hose 15 m	1
15990	glass pipes	50
15991	plastic pipes	50

FESTA

DIGITAL INCLINOMETER

- 0° - 360°
- accuracy $\pm 0,1^\circ$
- resolution $0,1^\circ$
- auto-off function
- HOLD function for measured value storing
- backlight display
- dimensions 60x60x25 mm
- battery 1xAAA



· bag

· magnetic bottom side



No. specification

26218



1

FESTA

DIGITAL PROTRACTOR

- LCD display
- measuring range $0^\circ - 360^\circ$
- resolution $0,1^\circ$
- accuracy $\pm 0,3$



No. specification

26217 200 mm



1

FESTA

DIGITAL PROTRACTOR

- LCD display
- measuring range $0^\circ - 225^\circ$
- resolution $0,1^\circ$
- accuracy $\pm 0,3$



No. specification

26216 300 mm



1

NEW



FESTA

CROSS-LINE GREEN LASER 3D

- 1x horizontal plane+2x vertical plane(green beam)
- self-levelling range $\pm 4^\circ$
- accuracy 0,2 mm/m
- indoor: 30 m, outdoor with detector 50 m
- pulse mode – recommended accessory receiver 26209
- inclusive: carrying case, 4xAA alkaline batteries, laser target, goggles, 2600 mAh Li-ion battery, professional bracket, charger, cradle of Li-ion battery

No. Specification
26204

1

NEW



FESTA

CROSS-LINE GREEN LASER

- 1x horizontal plane+1x vertical plane(green beam)
- self-levelling range $\pm 3^\circ$
- accuracy 0,2 mm/m
- indoor: 20 m, outdoor with detector 50 m
- pulse mode – recommended accessory receiver 26209
- inclusive: carrying case, 2xAA alkaline batteries, bracket

No. Specification
26201

1

NEW



FESTA

LASER RECEIVER

- for use with pulsed laser devices to extend the range then 50 m
- inclusive: 9 V battery, bracket
- for 26201, 26204



No.	Specification
26209	range: 50 m



NEW



FESTA

RANGE-FINDER

- measuring range 0,05 - 50 m
- measuring accuracy ± 2 mm, measuring unit mm/in/ft
- continuous measurement, area measurement, volume measurement, triangle leg measurement, LCD FSTN, addition/subtraction, max./min. measurement, max storage 100 units, backlight, laser class 630-670 nm class 2
- operating temperature 0 - 40°C
- size 112 x 50 x 25 mm, weight 90 g
- inclusive: carrying case, 2xAAA alkaline batteries



No.	Specification
26211	



Laserliner®

LUXTEST-MASTER

Professional lighting intensity measuring instrument

- Measurement of lighting intensity in workplaces, offices, public buildings and industry
- Sensitive photodiode with cosine correction for wide-angle light measurement
- Relative measurement function for reference and comparison measurement
- Peak function for registering fast changes in light levels
- Hold function
- Automatic and manual range changeover
- Zeroing function
- Measurement variables: Lux (lm | m²), foot candle (lm | ft²)
- Min | Max displayj
- 1 | 4" tripod connection



No.	specification
	Measuring range : 20 Lux ... 200000 Lux
26520	Lux accuracy: ± 3% (reference light bulb at 2854 K)
	Cosine angular deviation: ± 2% (30°), ± 6% (60°)



specification
Inclusive: battery, carrying case

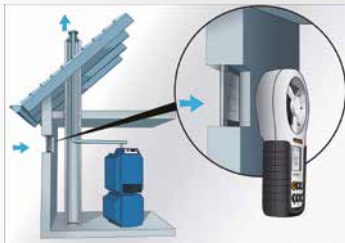

Laserliner®

AIRFLOWTEST-MASTER

Professional anemometer for measuring air flow, volumetric flow and wind speed

- Integrated sensor for measuring ambient temperature, relative humidity and dew point calculation
- USB interface for saving measured data
- PC software for real-time logging
- Large impeller: 65 mm
- Min | Max display
- 1 | 4" tripod connection for long-term measurement
- Illuminated, clearly arranged display with permanently visible ambient temperature and relative humidity



No.	specification
	Flow rate: 0.80...30 m s ± 2%
26521	Ambient temperature: -10...60°C ± 1.5°C
	Relative humidity: 20%...80% ± 3%
	Airflow: 0...99990 CMM



specification
Inclusive: PC software, USB Cable, batteries, carrying case



RECORDING ON A PC

Laserliner®

CONDENSESPOT PLUS

Infrared thermometer for locating thermal bridges and condensation moisture

- 8-point laser circle pinpoints the measuring zone exactly
- Measurement of surface |dew point temperature
- Localisation of condensation in thermal bridge mode with dew point display
- Localisation of thermal bridges and condensation water issues in thermal bridge mode with dew point display
- Temperature measurement range (-40°C...365°C)
- Emission ratio: 0.01...1.0 (adjustable)
- Colour alarm function: Thermal bridge warning with colour display
- Quick selection of 5 emissivity defaults with Fast Preset or exact setting by entering numerical value
- Bar graph condense water indicator
- Lens 12:1, illuminated display

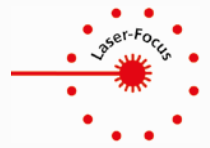

1



No.	specification
	Measuring range of infrared ray: -40°C ... 365°C
	Accuracy: ± -40°C ... 0°C (± 1°C + 0,1°C 1°C)) 0°C ... 30°C (± 1°C or ± 1%, depending on the higher value) >30°C (± 2°C or ± 2%, depending on the higher value)
26528	Ambient temperature: -20°C...65°C Accuracy: ± 1°C (0°C...50°C) ± 2,5°C (<0°C and >50°C)
	Air humidity (relative): 1%...99% Accuracy: ± 3% (20%...80%) ± 5% (<20% and >80%)
	Inclusive: batteries



Laserliner®

COMPACTCROSS - LASER PLUS

The automatic cross-line laser for aligning tiles, wall studding, windows, doors etc.

- The slope-mode feature is an extra that permits gradients to be laid out.
- RX-ready: integrated hand-held receiver mode
- Bluetooth® interface for remote control of the device
- Automatic levelling range 4°, Accuracy 0,35 mm |m



No.	specification
26037	Inclusive: battery



1



FESTA

STEEL PENCIL WITH CLIP HB



No.	specification	
13262	150 mm	20



FESTA

PENCIL WITH REMOVABLE GRAPHITE HB



No.	specification	
13279	pencil + graphite HB	24
13284	spare graphite 5 pcs	20

NEW



FESTA

COLORED PENCILS FOR CARPENTER PENCIL

pro | for 13262



No.	Specification	
13267	● 2x yellow ● 2x red ● 2x blue	1



FESTA

BLACK PENCILS HB FOR CARPENTER PENCIL

for 13262



No.	Specification	
13263	● 6x black	1



FESTA

CARPENTER PENCILS HB



No.	specification	
13270	HB · 180 mm	96
13271	HB · 180 mm · sada 3 ks	32
13265	HB · 250 mm	96



FESTA

CARPENTER PENCIL HB



No.	specification	
13269	HB · 180 mm	50
13266	HB · 250 mm	50

MOQ 50



FESTA
CARPENTER PENCIL HB



MOQ
12

No.	specification	
13272	HB · 250 mm	96
13264	HB · 250 mm · without print	96



FESTA
CARPENTER PENCIL HB

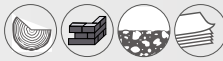

MOQ
50

No.	specification	
13268	250 mm	50



FESTA
TRIANGULAR PENCIL HB



MOQ
12

No.	specification	
13278	250 mm	96



FESTA
CARPENTER PENCIL HB



MOQ
12

No.	specification	
13280	180 mm	96



FESTA
PENCIL 6H



MOQ
12

No.	specification	
13275	6H · 250 mm	96



FESTA
PENCIL FOR GLASS, CERAMICS



MOQ
12

No.	specification	
13273	175 mm red graphite - glass, ceramics	144



FESTA

PENCILS WITH COLORFULL GRAPHITE

MOQ
12

No.	specification
13274	175 mm, red - blue

PENCILS WITH RED GRAPHITE

MOQ
12

No.	specification
13276	175 mm



· sanding paper

PENCIL SHARPENER

No.
13261

MOQ
12



PERMANENT MARKER



- extra strong tip
- for marking even on greasy and wet surfaces



MOQ
12

No.	specification	
13216	red	12
13217	black	12
13218	blue	12
13219	green	12



PERMANENT MARKER



- 2 types of markers tip
- for marking even on greasy and wet surfaces



No.	specification	
13227	white ALU pen body	40
13222	white PVC pen body	12
13228	red ALU pen body	40
13229	black ALU pen body	40
13230	blue ALU pen body	12
13231	green ALU pen body	12



PERMANENT MARKER



MOQ
12



No.	specification	
13214	white	12
13225	red	12
13226	black	12
13223	blue	12
13224	green	12



PERMANENT MARKER



MOQ
12



No.	specification	
13235	red	12
13236	black	12
13237	blue	12
13238	green	12



NEW



NEW



TWO SIDED PERMANENT MARKER - DIFFERENT THICKNESS



MOQ
12



No.	Specification	
13206	○ white	12



FESTA

PERMANENT MARKER

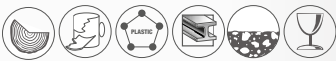

No.	Specification	
13246	● black	10

NEW

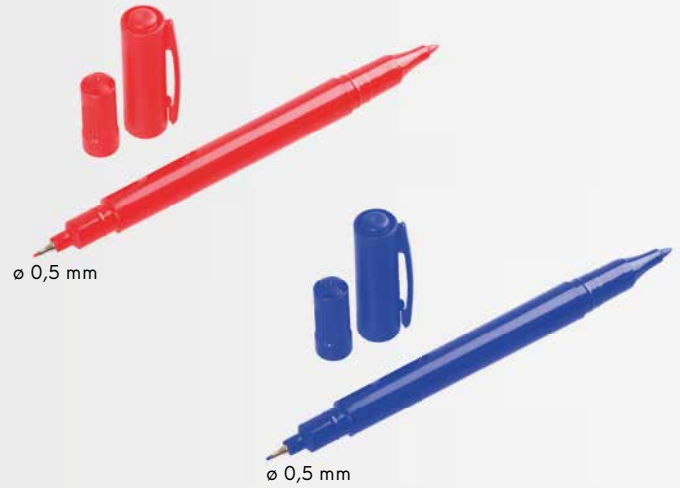

TWO SIDED PERMANENT MARKER - DIFFERENT THICKNESS



MOQ
12



No.	Specification	
13207	● red	12
13208	● blue	12



PERMANENT MARKER MINI



· length of marker 9 cm



MOQ
72



No.	specification	
13205	● ● ● ●	72



TWO SIDED PERMANENT MARKER - DIFFERENT THICKNESS



MOQ
12



No.	specification	
13212	black	12



FESTA

MARKING TOOL



No.	specification	
13281	150 mm	50



DRAWING-COMPASS



No.	specification	
13285	200 mm	10



FESTA

MARKING TOOL



No.	specification	
13282	200 mm	50



WHITE CHALK

12x



No.	specification	
13260	12 x 12 x 80 mm	46



FESTA

UNIVERSAL MARKER SET 5 PCS

· Ø 13 x 110 mm

5x



No.	specification		No.	specification	
13240	5 colour	20	13243	yellow	20
13241	red	20	13244	green	20
13242	black	20	13245	white	20



WAX CRAYON SET 6 PCS

6x



No.	specification	
13277	● ● ○ ● ● ●	88

SPRAY FLUORESCENT TRACKMARKER 500 ML

- High visibility due to fluorescent pigment
- Safety cap
- Quick drying 10 min.
- Durability 3 months
- Use - Concrete, Asphalt, Grass, Gravel, Sand, Stone, Wood

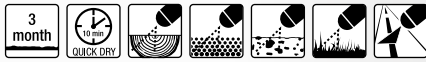

No.	specification	
13250	● yellow	12
13251	● red	12
13252	● orange	12
13253	● green	12
13254	● pink	12
13249	● blue	12



SPRAY FLUORESCENT MARK 6M FLUO 500 ML

- High visibility due to fluorescent pigment
- Safety cap
- Quick drying 10 min.
- Durability 6 months
- Use - Concrete, Asphalt, Grass, Gravel, Sand, Stone, Wood, Glass



No.	specification	
13360	● yellow	12
13361	● red	12
13362	● orange	12
13363	● green	12
13364	● pink	12
13365	○ white	12



SPRAY FLUORESCENT FLUO 500 ML

- High visibility due to fluorescent pigment
- Safety cap
- Quick drying 10 min.
- Durability 12 months
- Use - Concrete, Asphalt, Grass, Gravel, Sand, Stone, Wood, Glass



No.	specification	
13350	● yellow	12
13351	● red	12
13352	● orange	12
13353	● green	12
13354	● pink	12
13355	○ white	12



SPREY FLUORESCENT IDEAL 500 ML

- High visibility due to fluorescent pigment
- Safety cap
- Quick drying 10 min.
- Durability 12 months
- Use - Concrete, Asphalt, Grass, Gravel, Sand, Stone, Wood



No.	specification	
13255	● yellow	12
13256	● red	12
13257	● orange	12
13258	● green	12
13259	● pink	12



MOBILE SPREY HOLDER FOR SPRAY SOPPEC

- For spray trackmarker and Fluo



No.	specification	
13296		1

PISTOL SPREY HOLDER FOR SPRAY SOPPEC

- For spray trackmarker and Fluo



No.	specification	
13295		1



60

PLIERS



66

WRENCHES



68

BOLT CUTTER



70

TINSMITH PLIERS



73

GOLA SETS AND RATCHETS



82

HEADS, EXTENSIONS, ADAPTERS



87

SPANNERS



93

SCREWDRIVERS



101

BITS



110

HEX KEY SETS



115

HAMMERS, MALLETS



120

RUBBER MALLETS



122

AXES



125

CHISELS



126

CHISELS

WORKSHOP TOOLS 58 - 159



129

STAPLE GUNS



131

CLAMPS AND VICES



134

WORK BENCHES



136

RIVETERS



140

WELDING



143

THREAD RODS, WASHER, NUTS



144

COMPRESSOR, BLOW AND SPRAY GUNS



149

SAFETY EQUIPMENTS



155

MOUNTING BELTS,BAGS AND CASES

FESTA®



ERGONOMIC handle



FESTA

COMBINATION PLIERS



No.	specification	
17101	160 mm	6
17102	180 mm	6
17103	200 mm	6



FESTA

SIDE CUTTING PLIERS



No.	specification	
17148	180 mm	6

FESTA

SIDE CUTTING PLIERS



No.	specification	
17104	160 mm	6
17105	180 mm	6



FESTA

RADIAL PLIERS STRAIGHT



No.	specification	
17140	160 mm	6
17142	200 mm	6

FESTA

BENT NOSE PLIERS



No.	specification	
17145	160 mm	6
17146	200 mm	6



FESTA

COMBINATION PLIERS

DIN 5746				
No.	specification			
17001	160 mm	6		
17002	180 mm	6		
17003	200 mm	6		



FESTA

SIDE CUTTING PLIERS

DIN 5749				
No.	specification			
17004	160 mm	6		
17005	180 mm	6		



FESTA

SIDE CUTTING PLIERS

DIN 5749				
No.	specification			
17108	180 mm	6		



FESTA

CUTTING FRONT PLIERS

DIN 5749				
No.	specification			
17110	160 mm	6		



FESTA

RADIAL PLIERS STRAIGHT

DIN 5745				
No.	specification			
17006	160 mm	6		
17011	200 mm	6		



FESTA

PLIERS BENT NOSE

DIN 5745				
No.	specification			
17007	160 mm	6		
17008	200 mm	6		



FESTA

FLAT NOSE PLIERS

DIN 5746				
No.	specification			
17009	160 mm	6		



FESTA

ROUND NOSE PLIERS

DIN 5745				
No.	specification			
17010	160 mm	6		



FESTA

WIRE STRIPER PLIERS

DIN 5744			
No.	specification		
17024	160 mm	6	



COMBINATION PLIERS

DIN 5746		
No.	specification	
17094	160 mm	6
17095	180 mm	6
17096	200 mm	6



SIDE CUTTING PLIERS

DIN 5749		
No.	specification	
17097	160 mm	6
17098	180 mm	6



RADIAL PLIERS STRAIGHT

DIN 5745		
No.	specification	
17099	160 mm	6
17100	200 mm	6



FESTA

VDE COMBINATION PLIERS

△ 1000 V IEC/EN60900:2004

DIN 5746 CrV HRC 58-62



No.	specification	
17125	160 mm	6
17126	180 mm	6
17127	200 mm	6



FESTA

VDE SIDE CUTTING PLIERS

△ 1000 V IEC/EN60900:2004

DIN 5749 CrV HRC 58-62



No.	specification	
17128	160 mm	6



FESTA

VDE CABLE/WIRE CUTTERS

△ 1000 V IEC/EN60900:2004

CrV HRC 58-62



No.	specification	
17130	160 mm	6



FESTA

VDE RADIAL PLIERS STRAIGHT

△ 1000 V IEC/EN60900:2004

DIN 5745 CrV HRC 58-62



No.	specification	
17133	160 mm	6



FESTA

VDE BENT NOSE PLIERS

△ 1000 V IEC/EN60900:2004

DIN 5745 CrV HRC 58-62



No.	specification	
17135	160 mm	6



FESTA

VDE ROUND NOSE PLIERS

△ 1000 V IEC/EN60900:2004

DIN 5745 CrV HRC 58-62



No.	specification	
17137	160 mm	6



FESTA

VDE WIRE STRIPPER

△ 1000 V IEC/EN60900:2004

CrV DIN 5744



No.	specification	
17138	160 mm	6



CABLE STRIPPER AND CUTTER

No.	specification	
17180	∅ 0,75 - 2,5 mm	12



CABLE STRIPPER AND CUTTER

No.	specification	
17181	∅ 0,60 - 2,6 mm	10

NEW

FESTA

UNIVERSAL STRIPPING TOOL

AWG	mm ²
10	6,0
12	4,0
14	2,5
16	1,5
18	1,0
20	0,5

- coaxial cable RG6/59
- low voltage cable ∅ 8 - 13 mm

No.	specification	
16202	125 mm	



10

NEW



FESTA

ELECTRONICS DIAGONAL CUTTER

max Ø 0,2 - 2,1 mm

CrV

No.	Specification	
17047	140 mm	10

FESTA

COMBINATION PLIERS

No.	specification	
17041	110 mm	12



FESTA

SIDE CUTTING PLIERS MINI

No.	specification	
17042	110 mm	12

FESTA

END CUTTING PLIERS MINI

No.	specification	
17043	100 mm	12

FESTA

LONG NOSE PLIERS MINI

No.	specification	
17044	120 mm	12



FESTA

ROUND NOSE PLIERS MINI

No.	specification	
17045	120 mm	12

FESTA

PLIERS SET

4x

No.	specification	
17040		6



FESTA

RING PLIERS

No.	specification	
17190	180 mm inward	6
17191	180 mm outward	6

FESTA

RING PLIERS

No.	specification	
17192	180 mm inward	15
17193	180 mm outward	15

RING PLIERS

No.	specification	
17025	set	10



FESTA

MULTIFUNCTION PLIERS

- 9 functions
- bag

CrV

No.	specification
16232	



12



FESTA

MULTIFUNCTION FENCE PLIER

- for fence

CrV

No.	specification
17109	270 mm



4



QUICK GRIP WRENCH

No.	specification
17034	220 mm



5



QUICK GRIP WRENCH

No.	specification
17036	260 mm



5



QUICK GRIP WRENCH

No.	specification
17035	220 mm



10



QUICK GRIP WRENCH

No.	specification
17023	220 mm



6



FESTA
WATER PUMP PLIERS

CrV

No.	specification	range of jaw	
17059	180 mm	0 - 30 mm	6
17061	250 mm	0 - 30 mm	6
17062	300 mm	0 - 40 mm	6
17080	400 mm	0 - 84 mm	4



FESTA
WATER PUMP PLIERS

CrV

No.	specification	range of jaw	
17084	250 mm	0 - 30 mm	6



FESTA
WATER PUMP PLIERS

CrV

• large range of jaws

No.	specification	range of jaw	
17086	250 mm	0 - 50 mm	6



FESTA
WATER PUMP PLIERS

CrV

No.	specification	range of jaw	
17081	180 mm	0 - 30 mm	6
17014	250 mm	0 - 30 mm	6
17082	300 mm	0 - 50 mm	6



FESTA
WATER PUMP PLIERS
SELF ADJUSTABLE

CrV

No.	specification	range of jaw	
17079	250 mm	0 - 50 mm	6



FESTA
WATER PUMP PLIERS

CrV

No.	specification	range of jaw	
17012	250 mm	0 - 40 mm	6
17060	300 mm	0 - 50 mm	10



FESTA
WATER PUMP PLIERS

No.	specification	range of jaw	
17013	250 mm	0 - 30 mm	6
17033	300 mm	0 - 50 mm	6



**PLASTIC JAW
PROTECTOR FOR PLIERS**

• suitable for 17061, 17079, 17086

No.	specification	
17085	1 pair	1



FESTA

WRENCH 45°, S

CrV



No.	specification	
17067	1" 330 mm	1
17068	1,5" 420 mm	1
17069	2" 540 mm	1



FESTA

PIPE WRENCH 90°

CrV



No.	specification	
17075	1" 330 mm	1
17076	1,5" 420 mm	1
17077	2" 540 mm	1



FESTA

WRENCH 90°

CrV



No.	specification	
17070	2,5" 355 mm	12
17071	3" 455 mm	8
17072	3,5" 610 mm	10



FESTA

ADJUSTABLE WRENCH

CrV

No.	specification	
17063	230 mm	6
17064	300 mm	6

WRENCH

No.	specification	
17065	260 mm	36
17066	300 mm	36

FESTA

CUTTING PLIERS

- steel wires
- ACSR cables
- aircraft cable

CrV

max. Ø
12 mm



No.	specification	8
17039	24' 610 mm	



FESTA

CUTTING PLIERS FOR WIRE ROPES

- steel wires
- ACSR cables
- aircraft cable

CrV

max. Ø
6 mm



No.	specification	6
17029	200 mm	



FESTA

BOLT CUTTER PROFESSIONAL

- jaws for cables and wires

Cr-Mo

HRC 58-62



No.	specification	max. Ø drátu	max. Ø lanka	max. Ø kabelu	1
17055	14' 360 mm	max. 5 mm < 45 HRC	max. 3,5 mm	max. 8 mm	1
17056	18' 460 mm	max. 6 mm < 45 HRC	max. 5 mm	max. 10 mm	1
17057	24' 610 mm	max. 8 mm < 45 HRC	max. 7 mm	max. 12 mm	1
17058	30' 760 mm	max. 10 mm < 45 HRC	max. 9 mm	max. 14 mm	1
17046	35' 900 mm	max. 12 mm < 45 HRC	max. 10 mm	max. 16 mm	1



FESTA

BOLT CUTTER PROFESSIONAL

Cr-Mo

HRC 58-62

No.	specification	max. Ø drátu	1
17051	14' 360 mm	max. 5 mm < 45 HRC	1
17052	18' 450 mm	max. 6 mm < 45 HRC	1
17053	24' 610 mm	max. 8 mm < 45 HRC	1
17054	30' 760 mm	max. 10 mm < 45 HRC	1
17048	36' 910 mm	max. 12 mm < 45 HRC	1



BOLT CUTTER

No.	specification	max. Ø drátu	30
17028	14' 350 mm	max. 5 mm < 30 HRC	30
17020	18' 450 mm	max. 6 mm < 30 HRC	6
17021	24' 610 mm	max. 8 mm < 30 HRC	10
17022	30' 760 mm	max. 10 mm < 30 HRC	5



NEW



FESTA

BOLT CUTTER

- soft wire: Ø 6 mm
- medium wire: Ø 5 mm
- hard wire: Ø 4 mm

CrV

No.	Specification	
17078	200 mm	12



BOLT CUTTER

max. Ø
5 mm

No.	specification	
17038	8' 210 mm	10



FESTA

CARPENTER PINCERS

CrV

No.	specification	
17300	160 mm	1
17301	180 mm	10
17302	200 mm	6
17303 NEW	250 mm	1



FESTA

RABIT PINCERS

CrV

No.	specification	
17305	220 mm	5
17306 NEW	250 mm	1
17304	275 mm	6



CARPENTER PINCERS

No.	specification	
17015	160 mm	6
17016	180 mm	6
17017	200 mm	6



RABIT PINCERS

No.	specification	
17019	220 mm	6
17083	275 mm	6



FESTA

TINSMITH PLIER

No.	specification	
17089	150 x 215 mm	2



FESTA

TINSMITH PLIER

No.	specification	
17093	95 x 270 mm	6



FESTA

TINSMITH PLIER

No.	specification	
17090	60 x 280 mm	10



FESTA

TINSMITH PLIER 45°

No.	specification	
17091	60 x 280 mm	10



FESTA

TINSMITH PLIER 90°

No.	specification	
17092	60 x 260 mm	10



FESTA

TINMAN'S SNIPS PLIERS

No.	specification	
17112	straight 40 260 mm	6
17117	right 40 260 mm	6
17122	left 40 260 mm	6



FESTA

TINMAN'S SNIPS

No.	specification	
17111	straight 40 250 mm	6
17116	right 40 250 mm	6
17121	left 40 250 mm	6



FESTA

SNIPS

CrV



No.	specification	
17170	50 250 mm	6



FESTA

SNIPS

CrV



No.	specification	
17156	60 245 mm	6



FESTA

SNIPS

CrV



No.	specification	
17155	70 260 mm	6



SNIPS

CrV

No.	specification	
17167	70 300 mm	5



SNIPS

CrV

No.	specification	
17165	60 250 mm	5



SNIPS

CrV

No.	specification	
17169	35 250 mm	5



HAND NIBBLER

max 0,8 mm

No.	specification	
17186	265 mm	6

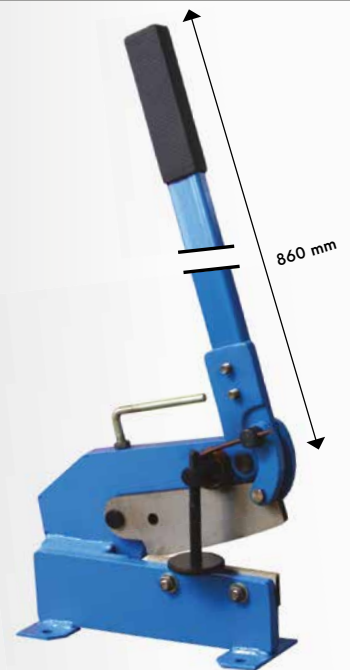

LEVER SHEARS

	17175	17177
	max. 4mm	5mm
	max. \varnothing 10mm	\varnothing 12mm
	max. 8x8mm	10x10mm

No.	specification	
17175	150 mm	1
17177	250 mm	1

ADAPTER FOR CUTTING PLATE - NIBBLER

Max plate thickness:

- 1,8 mm - steel
- 1,2 mm - stainless
- 2 mm - plastic, aluminium, copper



No.	specification	
20363		5



FESTA

PUNCHING TONGS



FESTA

PLIERS FOR THE PROFILE

· Use for: plinths, profiles, tubes



No.	specification	
17185	Ø 2; 2,5; 3; 3,5;4; 4,5 mm	12

No.	specification	
17050	60 220 mm ø 17 mm, ø 20 mm, ø 27 mm	8



SCISSORS

INOX



No.	specification	
16420	60 200 mm	12

SCISSORS

INOX



No.	specification	
17159	65 220 mm	12



SCISSORS

INOX



No.	specification	
17158	50 150 mm	10

SCISSORS SET

INOX

3x



No.	specification	
16401	3 pcs	48



SCISSORS

INOX



No.	specification	
17160	70 210 mm	12

SCISSORS

INOX

No.	specification	
16405	14 cm	24
16406	17 cm	24
16407	19 cm	24
16408	21,5 cm	12

FESTA®

10 years
guarantee

- for industry and services
- high quality Chrom Vanadium steel
- ratchet with 72 teeth for the most precise work
- all components according to DIN norm
- knurled heads for better grip
- strong plastic or metal case

made by

HONITON

FESTA made by **HONITON**

SOCKET SET

- 1/2" · 72 T
- 1/2" · 125 mm
- 1/2" · 8-9-10-11-12-13-14-15-17-19-22 mm

CrV **1/2"** **13x**

No. specification
17210



10 years
guarantee



1

FESTA made by **HONITON**

SOCKET SET

- 1/4" · 72 T
- 1/4" · 50 mm, 100 mm
- 1/4" · 4-4,5-5-5,5-6-7-8-9-10-11-12-13 mm

CrV **1/4"** **17x**

No. specification
17211









10 years
guarantee

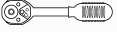

1

FESTA made by **HONITON**

SOCKET SET

-  1/2"
-  1/2" · 125 mm, 250 mm
-  1/2"
-  16 mm, 21 mm
-  1/2"
-  1/2" · 10-11-12-13-14-15-16-17-18-19-20-21-22-23-24-27-30-32 mm

CrV **1/2"** **25x**









No. specification
17212

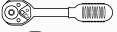

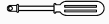
4

FESTA made by **HONITON**

SOCKET SET

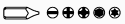
-  1/2", 1/4" · 72 T
-  1/2", 1/4"
-  1/4" · 150 mm
-  1/4" · 100 mm
-  1/2", 1/4"
-  1/2" · 125 mm, 250 mm
-  1/4" · 4-4,5-5-5,5-6-7-8-9-10-11-12-13 mm
-  1/2" · 10-11-12-13-14-15-17-19-21-22-24-27-30-32 mm
-  16 mm, 21 mm
-  18x

Inbus 3x
CrV **1/2"** **1/4"** **59x**







No. specification
17214



4

FESTA made by **HONITON**

SOCKET SET

-  1/2" · 72 T
-  1/2" · 125 mm, 250 mm
-  1/2"
-  16 mm, 21 mm
-  1/2"
-  1/2"
-  1/2" · 8-9-10-11-12-13-14-15-16-17-18-19-20-21-22-23-24-27-30-32 mm

CrV **1/2"** **28x**





No. specification
17213



4

FESTA made by **HONITON**

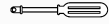
SOCKET SET

-  1/4" · 72 T
-  1/4" · 50 mm
-  1/4"
-  1/4"
-  1/4" · 4-4,5-5-5,5-6-7-8-9-10-11-12-13 mm

CrV **1/4"** **16x**

No. specification
17215



1

FESTA made by **HONLITON**

SOCKET SET

- 1/2" · 72 T
- 1/2" · 125 mm, 250 mm
- 1/2"
- 16 mm, 21 mm
- 1/2"
- 1/2" · 10-11-12-13-14-15-16-17-18-19-20-21-22-23-24-27-30-32 mm

CrV 1/2" 25x



10 years guarantee



No. specification
17216

10

FESTA made by **HONLITON**

SOCKET SET

- 1/4" · 72 T
- 1/4" · 50 mm
- 1/4"
- 1/4"
- 1/4"
- 1/4" · 4-4,5-5-5,5-6-7-8-9-10-11-12-13 mm
- 12x
- Inbus 3x

CrV 1/4" 32x



10 years guarantee



No. specification
17217

1

FESTA made by **HONLITON**

SOCKET SET

- 1/2", 1/4" · 72 T
- 1/2", 1/4"
- 1/4" 150 mm
- 1/4" 100 mm
- 1/2", 1/4"
- 1/2" · 125 mm, 250 mm
- 1/4" · 4-4,5-5-5,5-6-7-8-9-10-11-12-13 mm
- 1/2" · 10-11-12-13-14-15-17-19-21-22-24-27-30-32 mm
- 16 mm, 21 mm
- 16x
- Inbus 3x

CrV 1/4" 1/2" 56x



10 years guarantee



No. specification
17218

4

FESTA made by **HONLITON**

SOCKET SET

- 1/2", 1/4" · 72 T
- 1/2", 1/4"
- 1/4"
- 1/4" · 50 mm, 100 mm
- 1/2", 1/4"
- 1/2", 1/4"
- 1/2" 125 mm, 250 mm
- 1/4" · 4-4,5-5-5,5-6-7-8-9-10-11-12-13-14 mm
- 1/2" · 10-11-12-13-14-15-17-19-21-22-24-27-30-32 mm
- 1/4" · 6-7-8-9-10-11-12-13 mm
- 1/2" · 14-15-17-19-22 mm
- 16 mm, 21 mm
- 34x
- Inbus 3x

CrV 1/4" 1/2" 94x



10 years guarantee









No. specification
17219

3

FESTA made by **HONITON**

SOCKET SET

-  1/2" · 72 T
-  1/2" · 125 mm, 250 mm
-  1/2"
-  16 mm, 21 mm
-  1/2"
-  1/2" · 8-9-10-11-12-13-14-15-16-17-18-19-20-21-22-23-24-27-30-32 mm

CrV **1/2"** **27x**

No. specification
17225







10 years guarantee



4

FESTA made by **HONITON**

SOCKET SET

-  3/4" · 72 T
-  3/4" · 100 mm, 200 mm
-  3/4" · 460 mm
-  3/4" · 22-24-27-30-32-36-38-41-46-50 mm

CrV **3/4"** **14x**

No. specification
17226





10 years guarantee



1

FESTA made by **HONITON**

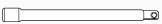
SOCKET SET

-  3/4" · 72 T
-  3/4" · 100 mm, 200 mm, 400 mm
-  3/4" · 460 mm
-  3/4" · 19-21-22-23-24-26-27-29-30-32-35-36-38-41-46-50 mm

CrV **3/4"** **21x**

No. specification
17227



10 years guarantee



1



FESTA made by **HONITON**

SET OF SOCKET BITS HEX

-  1/2" HEX · 4-5-6-7-8-10-12-14-17 mm

CrV **1/2"** **9x**

No. specification
17345

10 years guarantee



1



FESTA made by **HONITON**

SET OF SOCKET BITS TORX

-  T20-T25-T27-T30-T40-T45-T50-T55-T60 mm

CrV **1/2"** **9x**

No. specification
17346

10 years guarantee



1



FESTA made by **HONITON**

SET OF SOCKET

Cr-Mo 1/2" 3x

No.	specification	
17336	17 mm	5
17337	19 mm	5
17338	21 mm	5



FESTA made by **HONITON**

SET OF SOCKET

1/2" · 17-19-21 mm

Cr-Mo 1/2" 3x

No.	specification	
17335		1



FESTA made by **HONITON**

RATCHET

CrV

No.	specification	
17220	1/4" 36 teeth	20
17222	3/8" 36 teeth	10
17224	1/2" 36 teeth	6
17208	1/2" 72 teeth	6



SOCKET HEAD SET DRIVELOCK

4-5-5,5-6-7-8-9-10-11-12-13 mm

CrV 1/4" 12x

No.	specification	
17250		10



SOCKET HEAD SET TORX

1/4" · 5-6-7-8-10

1/2" · 12-14-16-18

CrV 1/2" 1/4" 9x

No.	specification	
17255		4



FESTA®

10 years
guarantee



Cr-Mo

- for use in industry and services
- high quality Chrom Vanadium steel
- ratchet with 72 teeth for the most precise work
- all components by DIN norm
- knurled heads for better grip
- strong case with steel lockers and steel hinges



FESTA

SET OF TOOLS

- | | |
|--|--|
| 1/2", 1/4" | 1/4" S 4 · 5.5 · 6.5 |
| 1/4" · 4-5-6-7-8-9mm | 1/4" PH 1 · 2 · 3 |
| 1/2" · 10-12-13-14-17-19mm | 1/4" PZ 2 · 3 |
| 1/4" · 4-4.5-5-5.5-6-7-8-9-10-11-12-13-14mm | 1/4" H 3 · 4 · 5 · 6 |
| 1/2" · 12-13-14-15-16-17-18-19-20-21-22-24mm | 1/4" T 8 · 10 · 15 · 20 · 25 |
| 1/2", 1/4" | 1/4" TTa 10 · 15 · 20 · 25 · 40 |
| 1/4" 1/4" → A/A4 | 2 · 2.5 · 3 · 4 · 5 · 6 · 7 · 8 · 10mm |
| 1/4" · 150mm | 8-9-10-11-12-13-14-15-16-17-18-19mm |
| 1/2" · 254mm | S 4x100 · 6.5x150 |
| 1/2", 1/4" | PH 2x100 · 3x150 |
| 1/2" · 16-21mm | 180mm |
| 1/4" · 150mm | 160mm |
| 1/2" · E10-E12-E14-E16-E18-E20-E22-E24 | 160mm |
| 1/4" S 3 · 4 · 5 · 6 | 250mm |
| 1/4" PH 0 · 1 · 2 | 300g |
| 1/4" PZ 0 · 1 · 2 | |



CrV S2 1/4" 1/2" 72T 122x ERGO HANDLE

No.	specification
17238	122 pcs



1

FESTA

SOCKET SET

- 1/2" · 72T
- 1/2" · 125 mm
- 1/2" · 10-11-12-13-14-15-17-19-22-24 mm

CrV 1/2" 72T 12x ERGO HANDLE

No.	specification
17245	15

10 years
guarantee



15

FESTA

SOCKET SET

- 1/2" · 72T
- 1/2" · 125 mm
- 1/2" · 10-11-12-13-14-15-17-19-22-24 mm

CrV 1/2" 72T 12x ERGO HANDLE

No.	specification
17229	8

10 years
guarantee



8





FESTA

SOCKET SET

- 1/2" · 72 T
- 1/2" · 75, 125 mm
- 1/2"
- 1/2" · 10-11-12-13-14-15-16-17-18-19-22-24 mm
- 1/2" · 17mm, 19mm
- 3 way adapter
- 16mm, 21mm



No. specification

17230



4

FESTA

SOCKET SET

- 1/4" · 72 T
- 1/4" · 50, 100 mm
- 1/4"
- 1/4" · 4-5-5,5-6-7-8-10-11-12-13 mm
- 1/4" · 6-7-8-10-12-13 mm
- 3 way adapter
- 4 x
- 11x
- 1x



No. specification

17231



10

FESTA

SOCKET SET

- 1/4"
- 1/4"
- 1/4" · 4-4,5-5-5,5-6-7-8-9-10-11-12-13-14 mm
- 1/4" · 50 mm, 100 mm
- 1/4"
- 1/4"
- 21 x
- 1/4"
- L 1/4"

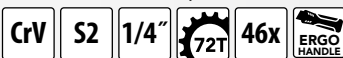

No. specification

17233



10

FESTA

SOCKET SET

- 1/2", 1/4" · 72T
- 1/4"
- 16 mm, 21 mm
- 1/4" · 10-11-12-13-14-15-16-17-18-19-20-21-22-23-24-27 mm
- 1/4" · 100 mm
- 1/2" · 125 mm, 250 mm
- 1/2"
- 1 x
- 1/4" · 4-5-5,5-6-7-8-10-11-12-13 mm
- 33 x

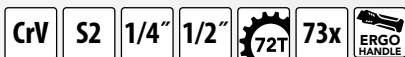

No. specification

17234



4

FESTA

SOCKET SET

- 1/2", 1/4" · 72T
- 1/4"
- 16 mm, 21 mm
- 1/4" · 4 -4,5-5-5,5-6-7-8-9-10-11-12-13-14 mm
- 1/2" · 10-11-12-13-14-15-16-17-18-19-20-21-22-23-24-27-30-32 mm
- 1/4" · 6-7-8-9-10-11-12-13 mm
- 1/2" · 14-15-17-19 mm
- 1/4" · 50 mm, 100 mm
- 1/2" · 125 mm, 250 mm
- 1/4"
- 5/16" bit holder
- 17x
- 15x
- 3 way adapter
- 3 x
- 1/4"
- L 1/4"
- 1/2", 1/4"

CrV S2 1/4" 1/2" 72T 94x ERGO HANDLE

No. specification

17235



10 years guarantee



4

FESTA

SOCKET SET

- 1/2", 1/4" · 72T
- 150 mm
- 16 mm, 21 mm
- 1/4" · 4 -4,5-5-5,5-6-7-8-9-10-11-12-13-14 mm
- 1/2" · 10-11-12-13-14-15-16-17-18-19-20-21-22-24-27-30-32 mm
- 1/4" · 6-7-8-9-10-11-12-13 mm
- 1/2" · 14-15-17-19-22 mm
- 1/4" · 50 mm, 100 mm
- 1/2" · 125 mm, 250 mm
- E · 4-5-6-7-8-10-11-12-14-16-18-20-24-27-30-32 mm
- 1/2", 1/4"
- 5/16" bit holder
- 18 x
- 17 x
- 3 way adapter
- 4 x
- 1/4"
- L 1/4"

CrV S2 1/4" 1/2" 72T 110x ERGO HANDLE

No. specification

17236



10 years guarantee



4

FESTA

SOCKET SET

- 1/2", 1/4", 3/8"
- 1/4" · 4-5-6-7-8-9-10mm
- 3/8" · 10-11-12-13-14-15mm
- 1/2" · 16-17-18-19-22mm
- 1/4" · 4-4,5-5-5,5-6-7-8-9-10-11-12-13-14mm
- 3/8" · 10-11-12-13-14-15-16-17-18-19mm
- 1/2" · 10-11-12-13-14-15-16-17-18-19-20-21-22-24-27-30-32mm
- 1/4" · E4-E5-E6-E7-E8
- 3/8" · E10-E11-E12-E14-E16-E18
- 1/2" · E20-E24
- 1/2" · 24x
- 1/4" · 20x
- 1/4" · 30x
- 1/4" · 50 mm, 100 mm
- 1/2" · 125 mm, 250 mm
- 3/8" · 150 mm
- 1/2", 1/4", 3/8" bit holder
- 1/2", 1/4", 3/8"
- 1/4" · 150mm
- 1/4" · 115mm
- Inbus 7X

CrV S2 1/4" 1/2" 3/8" 72T 171x ERGO HANDLE

No. specification

17237



10 years guarantee



2

FESTA®



- ratchet is made from the best quality ChromVanadium steel
- ratchet with 72 teeth for most precise work
- quality ergonomic, two-component handle made of softened TPE rubber
- SYSTEM QUICK RELEASE for quick and easy changing of socket heads



FESTA®

RATCHET



No.	specification	length	
17297	1/4"	155 mm	6
17298	3/8"	210 mm	5
17299	1/2"	255 mm	4

FESTA®

RATCHET



No.	specification	length	
17240	1/4"	155 mm	10
17241	3/8"	200 mm	10
17242	1/2"	250 mm	5



FESTA®

RATCHET



No.	specification	length	
17294	1/4"	155 mm	6
17295	3/8"	205 mm	10
17296	1/2"	255 mm	4

FESTA®

REVERSIBLE RATCHET 1/4"



No.	specification	
17292	1/4"	1



RATCHET



No.	specification	
17243	1/4"	25
17244	1/2"	25

FESTA®

ADAPTER FOR SOCKETS

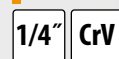

No.	specification	
18603	1/4" 150 mm	10

NEW



UNIVERSAL SOCKET HEAD



No.	Specification	
17812	10 - 19 mm	1



UNIVERSAL SOCKET HEAD



No.	Specification	
17810	for screws 7 - 19mm • 52mm x ø26mm	1



UNIVERSAL SOCKET HEAD



No.	Specification	
17811	for screws 11 - 32mm • 83mm x ø43mm	5

FESTA

SOCKET HEAD DEEP LONG 1/4"



No.	Specification		No.	Specification	
17860	4 mm • 50 mm	10	17866	10 mm • 50 mm	10
17861	5 mm • 50 mm	10	17867	11 mm • 50 mm	10
17862	6 mm • 50 mm	10	17868	12 mm • 50 mm	10
17863	7 mm • 50 mm	10	17869	13 mm • 50 mm	10
17864	8 mm • 50 mm	10	17870	14 mm • 50 mm	10
17865	9 mm • 50 mm	10			



FESTA

SOCKET HEAD 1/4"



No.	Specification		No.	Specification	
17820	4 mm • 25 mm	10	17827	9 mm • 25 mm	10
17821	4,5 mm • 25 mm	10	17828	10 mm • 25 mm	10
17822	5 mm • 25 mm	10	17829	11 mm • 25 mm	10
17823	5,5 mm • 25 mm	10	17830	12 mm • 25 mm	10
17824	6 mm • 25 mm	10	17831	13 mm • 25 mm	10
17825	7 mm • 25 mm	10	17832	14 mm • 25 mm	10
17826	8 mm • 25 mm	10			



FESTA

SOCKET HEAD DEEP (LONG) 1/2"



No.	Specification		No.	Specification	
17871	10 mm • 70 mm	10	17882	21 mm • 70 mm	10
17872	11 mm • 70 mm	10	17883	22 mm • 70 mm	10
17873	12 mm • 70 mm	10	17884	23 mm • 70 mm	10
17874	13mm • 70 mm	10	17885	24 mm • 70 mm	10
17875	14 mm • 70 mm	10	17886	25 mm • 70 mm	10
17876	15 mm • 70 mm	10	17887	26 mm • 70 mm	10
17877	16 mm • 70 mm	10	17888	27 mm • 70 mm	10
17878	17 mm • 70 mm	10	17889	28 mm • 70 mm	10
17879	18 mm • 70 mm	10	17890	30 mm • 70 mm	10
17880	19 mm • 70 mm	10	17891	32 mm • 70 mm	10
17881	20 mm • 70 mm	10	17892	34 mm • 70 mm	10



FESTA

SOCKET HEAD 1/2"



No.	Specification		No.	Specification	
17308	8 mm • 38 mm	10	17319	19 mm • 38 mm	10
17309	9 mm • 38 mm	10	17320	20 mm • 38 mm	10
17310	10 mm • 38 mm	10	17321	21 mm • 38 mm	10
17311	11 mm • 38 mm	10	17322	22 mm • 38 mm	10
17312	12 mm • 38 mm	10	17324	24 mm • 38 mm	10
17313	13 mm • 38 mm	10	17327	27 mm • 42 mm	20
17314	14 mm • 38 mm	10	17330	30 mm • 42 mm	25
17315	15 mm • 38 mm	10	17332	32 mm • 42 mm	20
17316	16 mm • 38 mm	10	17333	34 mm • 42 mm	20
17317	17 mm • 38 mm	10	17334	36 mm • 42 mm	20
17318	18 mm • 38 mm	10			





FESTA

SOCKET HEAD 3/4"



No.	specification	
17835	17 mm · 48 mm	10
17836	18 mm · 48 mm	10
17837	19 mm · 48 mm	10
17838	21 mm · 48 mm	10
17839	22 mm · 48 mm	10
17840	24 mm · 48 mm	10
17841	26 mm · 48 mm	10
17842	27 mm · 52 mm	10
17843	28 mm · 52 mm	10
17844	30 mm · 52 mm	10
17845	32 mm · 52 mm	10

No.	specification	
17846	33 mm · 55 mm	10
17847	36 mm · 60 mm	10
17848	38 mm · 60 mm	10
17849	41 mm · 65 mm	10
17850	46 mm · 65 mm	10
17851	50 mm · 70 mm	10
17852	55 mm · 75 mm	10
17853	60 mm · 78 mm	10
17854	65 mm · 82 mm	10
17855	70 mm · 82 mm	10
17856	75 mm · 88 mm	10



FESTA

SOCKET HEAD - MULTIDRIVE 1/4"



No.	specification	
17895	4 mm · 25 mm	10
17896	4,5 mm · 25 mm	10
17897	5 mm · 25 mm	10
17898	5,5 mm · 25 mm	10

No.	specification	
17902	9 mm · 25 mm	10
17904	11 mm · 25 mm	10
17905	12 mm · 25 mm	10
17907	14 mm · 25 mm	10



FESTA

SOCKET HEAD - MULTIDRIVE 1/2"



No.	specification	
17910	8 mm · 38 mm	10
17912	10 mm · 38 mm	10
17913	11 mm · 38 mm	10
17914	12 mm · 38 mm	10
17916	14 mm · 38 mm	10

No.	specification	
17922	21 mm · 38 mm	10
17924	24 mm · 38 mm	10
17925	27 mm · 38 mm	10
17926	30 mm · 38 mm	10
17927	32 mm · 38 mm	10



FESTA

TORX SOCKET 1/4"



No.	specification	
17930	E4	10
17931	E5	10
17932	E6	10

No.	specification	
17933	E7	10
17934	E8	10
17935	E10	10



FESTA

TORX SOCKET 1/2"



No.	specification	
17943	E22	10
17944	E24	10



FESTA

SLOTTED SOCKET BIT 1/4"

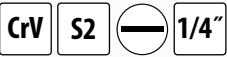

No.	specification	
18920	S 4 mm	10
18921	S 5,5 mm	10
18922	S 7 mm	10



FESTA

PHILIPS SOCKET BIT 1/4"

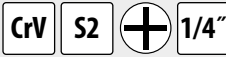

No.	specification	
18925	PH 1	10
18926	PH 2	10
18927	PH 3	10



FESTA

POZIDRIVE SOCKET BIT 1/4"



No.	specification	
18928	PZ 0	10
18929	PZ 1	10
18930	PZ 2	10
18931	PZ 3	10



FESTA

XZN SOCKET BIT 1/2"



No.	specification	
18971	M 16	10



FESTA

HEX SOCKET BIT 1/4"



No.	specification	
18934	3 mm	10
18937	6 mm	10
18939	8 mm	10



FESTA

HEX SOCKET BIT 1/2"



No.	specification	
18944	12 mm	10
18945	14 mm	10



FESTA

TORX SOCKET BIT 1/4"



No.	specification	
18948	T 5	10
18950	T 8	10
18951	T 10	10



FESTA

TORX SOCKET BIT 1/2"



No.	specification		No.	specification	
18954	T 10	10	18960	T 40	10
18955	T 15	10	18961	T 45	10
18956	T 20	10	18963	T 55	10
18957	T 25	10			



FESTA
ADAPTER

CrV

No.	specification	
17410	A - 1/4" B - 3/8"	10
17411	A - 3/8" B - 1/4"	10
17412	A - 3/8" B - 1/2"	10
17413	A - 1/2" B - 3/8"	10



FESTA
UNIVERSAL JOIN

CrV

No.	specification	
17405	1/4" · 39 mm	10
17406	1/2" · 71 mm	10
17407	3/4" · 105 mm	10



FESTA
T-M HEAD FOR SLIDING BAR

CrV

No.	specification	
17420	1/4"	1
17421	1/2"	1
17422	3/4"	1



FESTA
SLIDING „T“ BAR

CrV

No.	specification	
17382	1/4" · 115 mm	1
17383	3/8" · 190 mm	1
17384	1/2" · 250 mm	1
17385	3/4" · 460 mm	1
17386	1' · 640 mm	1



FESTA
EXTENSION WRENCH WITH SOCKET

CrV

No.	specification	
17401	1/4" · 250 mm	1
17402	1/2" · 400 mm	1



FESTA
SWIVEL HANDLE

CrV

No.	specification	
17380	1/2" · 350 mm	1
17381	3/4" · 500 mm	1



FESTA
L HANDLE

CrV 1/2"

No.	specification	
17427	1/2" · 60 x 320 mm	1





FESTA

EXTENSION BAR

CrV

No.	specification	
17390	1/4" · 50 mm	1
17391	1/4" · 100 mm	1
17392	1/4" · 150 mm	1
17393	1/2" · 75 mm	1
17394	1/2" · 125 mm	1



FESTA

FLEXIBLE EXTENSION BAR

CrV 1/4"

No.	specification	
17400	1/4" · 150 mm	1



Stahlberg

ADAPTER RATCHET 1/4" - BIT

CrV

1/4" ↔ 1/4"



No.	specification	
18619		5



SET OF ADAPTERS

CrV 1/4" 3x

No.	specification	
18604	1/4", 3/8", 1/2"	10



NEW

RADIATOR BLEED KEY WITH WATER TANK



No.	specification	
17459	50 ml	1

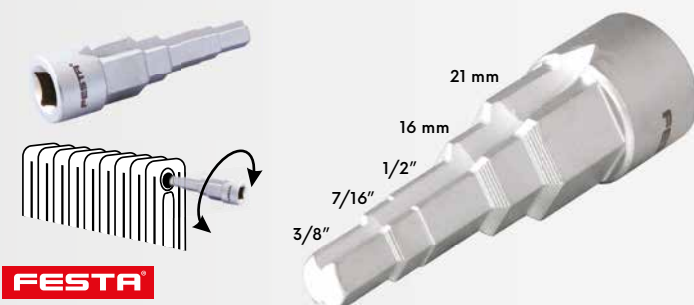

FESTA

UNIVERSAL SPUD WRENCH

CrV 1/2"

No.	specification	
17455	for ratchet 1/2"	10



NEW

FESTA

UNIVERSAL KEY FOR SWITCH CABINET

8-9 mm
 6 mm
 8 mm
 6-9 mm
 1,0 x 7 mm
 PH2



No.	Specification	
17458		1



FESTA

UNIVERSAL KEY FOR SWITCH CABINET

D 11-12
 A 7-8
 A 6-7
 D 3-5
 1,0 x 7 mm
 PH2

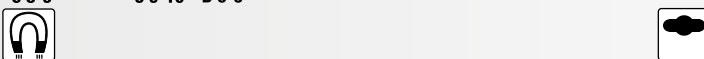

No.	specification	
17456		50

FESTA®

- forged keys made of CrV grade steel
- made according to DIN standards
- chrome coating



FESTA®

DOUBLE OPEN SPANNER

CrV **DIN 3110**



No.	specification	
17550	6 x 7 mm	10
17551	8 x 9 mm	10
17552	8 x 10 mm	10
17553	10 x 11 mm	10
17590	10 x 13 mm	10
17554	12 x 13 mm	10
17555	14 x 15 mm	10
17556	13 x 16 mm	10
17557	13 x 17 mm	10
17591	14 x 17 mm	10
17558	16 x 17 mm	10
17559	17 x 19 mm	10
17560	18 x 19 mm	10

No.	specification	
17592	19 x 22 mm	10
17593	19 x 24 mm	10
17561	20 x 22 mm	10
17569	21 x 23 mm	10
17548	22 x 24 mm	10
17562	24 x 27 mm	10
17549	24 x 30 mm	10
17563	30 x 32 mm	10
17564	30 x 34 mm	10
17565	32 x 36 mm	10
17566	36 x 41 mm	10
17567	46 x 50 mm	10
17568	50 x 55 mm	3

FESTA®

COMBINATION SPANNER

CrV **DIN 3113**



No.	specification	
17487	6 mm	10
17570	7 mm	10
17571	8 mm	10
17572	9 mm	10
17573	10 mm	10
17574	11 mm	10
17575	12 mm	10
17576	13 mm	10
17577	14 mm	10
17578	15 mm	10
17579	16 mm	10
17580	17 mm	10
17581	18 mm	10
17582	19 mm	10
17488	20 mm	10

No.	specification	
17489	21 mm	10
17583	22 mm	10
17490	23 mm	10
17584	24 mm	10
17491	25 mm	10
17492	26 mm	10
17585	27 mm	10
17493	28 mm	10
17494	29 mm	10
17586	30 mm	10
17587	32 mm	10
17495	33 mm	10
17496	34 mm	10
17589	36 mm	10



FESTA®

RATCHET SWIVEL SPANNER

CrV **72T**



No.	specification	
17628	8 mm	10
17622	10 mm	10
17623	13 mm	10
17624	14 mm	10
17629	15 mm	10
17630	16 mm	5

No.	specification	
17625	17 mm	10
17631	18 mm	10
17626	19 mm	10
17632	21 mm	5
17633	22 mm	5

FESTA®

RATCHET SPANNER

CrV **72T**



No.	specification	
17660	6 mm	10
17676	7 mm	10
17661	8 mm	10
17662	9 mm	10
17663	10 mm	10
17664	11 mm	10
17665	12 mm	10
17666	13 mm	10
17667	14 mm	10
17668	15 mm	10

No.	specification	
17669	16 mm	10
17670	17 mm	10
17671	18 mm	10
17672	19 mm	10
17674	21 mm	5
17675	22 mm	5
17677	24 mm	5
17678	27 mm	5
17679	30 mm	5
17683	32 mm	5



FESTA

RING SPANNER

CrV DIN 838

No.	specification	
17605	6 x 7 mm	10
17606	8 x 9 mm	10
17607	8 x 10 mm	10
17608	10 x 11 mm	10
17609	12 x 13 mm	10
17611	13 x 16 mm	10
17612	13 x 17 mm	10

No.	specification	
17610	14 x 15 mm	10
17613	16 x 17 mm	10
17614	18 x 19 mm	10
17615	20 x 22 mm	10
17616	24 x 27 mm	10
17617	30 x 32 mm	10



FESTA

DOUBLEOPEN SPANNER DIN 895

DIN 895



No.	specification	
17460	6 x 7 mm	10
17461	8 x 9 mm	10
17462	8 x 10 mm	10
17463	10 x 11 mm	10
17481	10 x 13 mm	10
17464	12 x 13 mm	10
17465	14 x 15 mm	10
17466	13 x 16 mm	10
17467	13 x 17 mm	10
17482	14 x 17 mm	10
17468	16 x 17 mm	10

No.	specification	
17469	17 x 19 mm	10
17470	18 x 19 mm	10
17483	19 x 22 mm	10
17484	19 x 24 mm	10
17471	20 x 22 mm	10
17472	24 x 27 mm	10
17486	21 x 23 mm	10
17480	28 x 30 mm	10
17473	30 x 32 mm	10
17485	36 x 41 mm	10



FESTA

DOUBLEOPEN SPANNER

CrV DIN 3110



No.	specification	
17761	14 x 15 mm	10
17769	20 x 22 mm	10

FESTA

COMBINATION SPANNER

CrV DIN 3113



No.	specification	
17788	14 mm	10
17789	15 mm	10

No.	specification	
17795	21 mm	10
17806	33 mm	10



12-13-14-15 mm

16-17-18-19 mm

SOCKET WRENCH

Cr-Mo



No.	specification	
17685	12-13-14-15-16-17-18-19 mm	1



FESTA

ADJUSTABLE WRENCH

CrV



No.	range	length	
17197	0 - 29 mm	200 mm	1
17198	0 - 33 mm	250 mm	1
17199	0 - 38 mm	300 mm	1

ADJUSTABLE WRENCH

No.	range	length	
17200	0 - 24 mm	200 mm	6
17201	0 - 30 mm	250 mm	6
17202	0 - 34 mm	300 mm	6



FESTA

OPEN - END WRENCH SET

CrV

DIN 3110



No.	specification	
17506	6 pcs · 6 x 7, 8 x 9, 10 x 11, 12 x 13, 14 x 15, 16 x 17	1
17508	8 pcs · 6 x 7, 8 x 9, 10 x 11, 12 x 13, 14 x 15, 16 x 17, 18 x 19, 20 x 22	1



FESTA

COMBINATION SPANNER SET

CrV

DIN 3113



No.	specification	
17526	6 pcs · 10 x 10, 11 x 11, 13 x 13, 14 x 14, 16 x 16, 17 x 17	1
17528	8 pcs · 8 x 8, 10 x 10, 11 x 11, 13 x 13, 14 x 14, 16 x 16, 17 x 17, 19 x 19	1



FESTA

RINGSPANNER SET

CrV

DIN 838

8x



No.	specification	
17539	6 x 7, 8 x 9, 10 x 11, 12 x 13, 14 x 15, 16 x 17, 18 x 19, 20 x 22	1



FESTA

OPEN - END WRENCH SETS

CrV

DIN 3110

12x



No.	specification	
17512	6 x 7, 8 x 9, 10 x 11, 12 x 13, 14 x 15, 16 x 17, 18 x 19, 20 x 22, 21 x 23, 24 x 27, 25 x 28, 30 x 32	1



FESTA

COMBINATION SPANNER SETS

CrV

DIN 3113



No.	specification	
17532	12 pcs · 8 x 8, 9 x 9, 10 x 10, 11 x 11, 13 x 13, 14 x 14, 16 x 16, 17 x 17, 18 x 18, 19 x 19, 21 x 21, 22 x 22	10
17533	18 pcs · 6 x 6, 7 x 7, 8 x 8, 9 x 9, 10 x 10, 11 x 11, 12 x 12, 13 x 13, 14 x 14, 15 x 15, 16 x 16, 17 x 17, 18 x 18, 19 x 19, 20 x 20, 21 x 21, 22 x 22, 24 x 24	1
17534	25 pcs · 6 x 6, 7 x 7, 8 x 8, 9 x 9, 10 x 10, 11 x 11, 12 x 12, 13 x 13, 14 x 14, 15 x 15, 16 x 16, 17 x 17, 18 x 18, 19 x 19, 20 x 20, 21 x 21, 22 x 22, 23 x 23, 24 x 24, 25 x 25, 26 x 26, 27 x 27, 28 x 28, 30 x 30, 32 x 32	4



FESTA

OPEN END SPANNER SETS DIN 895

DIN 895



No.	specification	
17475	8 pcs · 6 x 7, 8 x 9, 10 x 11, 12 x 13, 14 x 15, 16 x 17, 18 x 19, 20 x 22	5
17476	12 pcs · 6 x 7, 8 x 9, 10 x 11, 12 x 13, 14 x 15, 16 x 17, 18 x 19, 20 x 22, 21 x 23, 24 x 27, 28 x 30, 30 x 32	3



FESTA

RATCHET SPANNER SET

CrV 72T 7x

No.	specification	
17620	8, 10, 12, 13, 14, 17, 19	5



FESTA

RATCHET SWIVEL SPANNER SET

CrV 72T 7x

No.	specification	
17621	10, 12, 13, 14, 15, 17, 19	5



FESTA

TUBULAR SPANNER SET

CrV 7x



No.	specification	
17501	6 x 7, 8 x 9, 10 x 11, 12 x 13, 14 x 15, 16 x 17, 18 x 19	20
17640	tommy bar · 135 mm	50



FESTA

HOOK SPANNER

CrV



No.	specification	
17680	19 - 51 mm 165 mm	5
17681	32 - 76 mm 216 mm	5
17682	51 - 121 mm 267 mm	5

FESTA

TUBULAR SPANNER

CrV



No.	specification		No.	specification	
17650	6 x 7 mm	10	17655	16 x 17 mm	10
17651	8 x 9 mm	10	17645	16 x 18 mm	10
17642	8 x 10 mm	10	17653	16 x 21 mm	10
17652	10 x 11 mm	10	17656	18 x 19 mm	10
17643	12 x 13 mm	10	17657	19 x 22 mm	10
17654	14 x 15 mm	10	17659	22 x 24 mm	10
17644	14 x 17 mm	10	17658	24 x 27 mm	10



KEY FOR ANGLE GRINDER ADJUSTABLE



No.	specification	
20967	200 mm	15

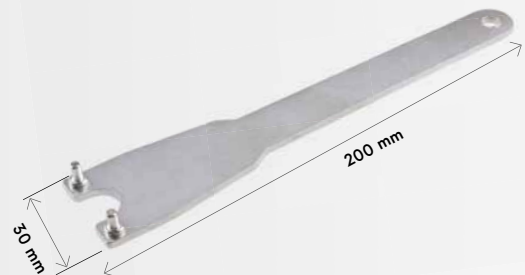

WRENCH FOR ANGLE GRINDER



No.	specification	
20968	200 mm	1



FESTA

TORQUE WRENCH

No.	specification		
17203	1/4" 5 - 25 Nm		1
17204	1/2" 19 - 110 Nm		1
17205	1/2" 42 - 210 Nm		1
17206	3/4" 140 - 700 Nm		1



FESTA

SCAFFOLDING RATCHET

No.	specification		
17451	18 mm		10
17450	19 mm		10



WHEEL SPANNER, CROSS



No.	specification		
17600	17, 19, 22 mm, 13/16"		16



WHEEL SPANNER, CROSS



No.	specification		
17601	17, 19, 21 mm		20



TELESCOPIC WHEEL SPANNER



No.	specification		
17603	17 x 19 mm, 21 x 23 mm		20



SOCKET WRENCH WITH JOINT



No.	specification		
17261	16 mm		1
17262	21 mm		1



FESTA

MAGNETIC TOOL HOLDER



No. specification

70098

12



FESTA

MAGNETIC TELESCOPE PICK UPPER - LED LIGHT



No. specification

13294

6

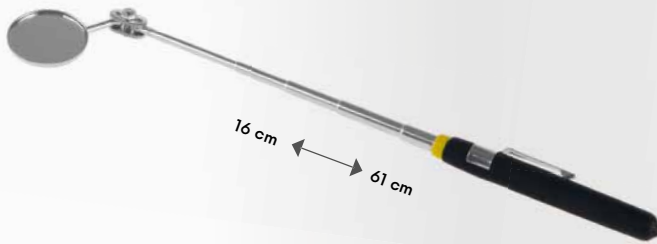

INSPECTION MIRROR TELESCOPE



No. specification

13290

20

No. specification

13293

20

MAGNETIC TELESCOPE PICK UPPER

FESTA[®]

- shaft made of quality S2 steel
- magnetic ending
- ergonomic two-component with softened TPE rubber



FESTA
SCREWDRIVER

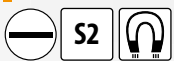

No.	specification	
18113	3 x 75 mm	12
18114	4 x 100 mm	12
18115	5,5 x 125 mm	12
18116	6,5 x 150 mm	12
18118	8 x 175 mm	6
18120	10 x 200 mm	6



FESTA
SCREWDRIVER SHORT

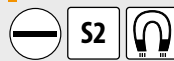

No.	specification	
18124	5,5 x 38 mm	12
18125	6,5 x 38 mm	12



FESTA
PHILIPS SCREWDRIVER



No.	specification	
18210	0 x 75 mm	12
18211	1 x 75 mm	12
18212	2 x 100 mm	12



FESTA
PHILIPS SCREWDRIVER SHORT

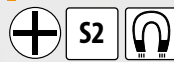

No.	specification	
18215	1 x 38 mm	12
18216	2 x 38 mm	12



FESTA
POZIDRIVE SCREWDRIVER

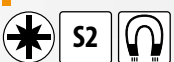

No.	specification	
18310	0 x 75 mm	12
18311	1 x 100 mm	12
18312	2 x 100 mm	12
18313	3 x 150 mm	6



FESTA
POZIDRIVE SCREWDRIVER SHORT

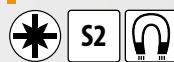

No.	specification	
18321	1 x 38 mm	12
18322	2 x 38 mm	12



FESTA

TORX SCREWDRIVER



No.	specification	
18350	T6	12
18351	T7	12
18352	T8	12
18353	T9	12
18354	T10	12
18355	T15	12



FESTA

SOCKET SCREWDRIVER



No.	specification	
18455	6 mm	12
18456	7 mm	12
18460	13 mm	12



FESTA

IMPACT SCREWDRIVER



No.	specification		No.	specification	
18062	5,5 x 100 mm	12	18065	10 x 175 mm	6
18063	7 x 125 mm	6	18066	10 x 200 mm	6
18064	8 x 150 mm	8	18067	10 x 250 mm	6



FESTA

VDE SCREWDRIVER



No.	specification	
18088	3 x 75 mm S2	12
18089	4 x 100 mm CrV	12
18090	5,5 x 125 mm CrV	12
18091	6,5 x 150 mm CrV	12
18092	8 x 175 mm CrV	12



FESTA

PHILIPS IMPACT SCREWDRIVER



No.	specification	
18070	PH 1 x 80 mm	8
18071	PH 2 x 100 mm	12
18072	PH 3 x 150 mm	6



FESTA

PHILIPS VDE SCREWDRIVER



No.	specification	
18080	PH 0 x 60 mm S2	12
18081	PH 1 x 80 mm CrV	12
18082	PH 2 x 100 mm CrV	12
18083	PH 3 x 150 mm CrV	12



FESTA

POZIDRIVE IMPACT SCREWDRIVER



No.	specification	
18075	PZ 1 x 80 mm	12
18076	PZ 2 x 100 mm	12
18077	PZ 3 x 150 mm	6



FESTA

POZIDRIVE VDE SCREWDRIVER



No.	specification	
18084	PZ 0 x 60 mm S2	12
18085	PZ 1 x 80 mm CrV	12
18086	PZ 2 x 100 mm CrV	12
18087	PZ 3 x 150 mm CrV	12





FESTA

SCREWDRIVER SET

⊖ S 3x75 · 5x100 · 6x175mm

⊕ PH 0 · 1 · 2 · 3



No. specification
18402

6



FESTA

SCREWDRIVER SET

⊖ S 3 x 75 · 4x100 · 5,5x125 · 6,5 x 150mm

⊕ PH 1 x 100 · 2 x 100mm

○ adapter 1/4"

bits: ⊖ S 4 · 5 · 6 · 7

⊕ PH 1 · 2 · 3

⊛ PZ 1 · 2 · 3

⊛ T 10 · 15 · 20 · 25 · 30

● H 2 · 3 · 4 · 5 · 6



No. specification
18422 27 pcs

6



FESTA

SCREWDRIVER SET

⊖ S 3x75 · 5x100 · 6x150mm

⊕ PH 0 · 1 · 2



No. specification
18403

6



FESTA

SCREWDRIVER SET

⊖ S 3x60 · 6x100 · 6x125mm

⊛ PZ 0 · 1 · 2



No. specification
18404

6



FESTA

SCREWDRIVER SET

⊖ S 6x38 · 5x75 · 6x100 · 8x150mm
2,5x50 · S 3x50mm

⊕ PH 2x38 · 1x75 · 2x100 · 3x150mm
0x50 · 00x50mm

⊛ T 5x50 · 6x50 · 7x50 · 8x50 · 9x50 · 10x50mm



No. specification
18424

6



FESTA

SCREWDRIVER SET TORX

⊛ T 10 · 15 · 20 · 25 · 30



No. specification
18340

6



FESTA

SCREWDRIVER SET

- ⊖ S 5 · 6 · 8 mm
- ⊕ PH 1 · 2 · 3

CrV **6x**



No. specification
18423

10



FESTA

ELECTRO SCREWDRIVER SET

- ⊖ S 4x100 · 5,5x125 mm · voltage detector 0 - 250 V
- ⊕ PH 0x60 · 1x80 · 2x100 mm

⊖ ⊕ **6x**

No. specification
18413

6



FESTA

SCREWDRIVER + 6 BITS

- ⊖ S 7 x 35 · 8 x 35 · 8 x 70 mm
- ⊕ PH 2 x 35 · 3 x 35 · 3 x 70 mm

CrV **6x**



No. specification
18411

1



FESTA

ELECTRO SCREWDRIVER SET

- ⊖ S 4x100 · 5,5x125 · 6,5x150 mm · voltage detector 0 - 250 V
- ⊕ PH 0x75 · 1x100 · 2x100 mm

⊖ ⊕ **7x**

No. specification
18410

40



FESTA

BOTTLE OPENER



No. specification
18437

5



VOLTAGE DETECTOR

DIN VDE 0680
73/23 EEC



No. specification
18426 0 - 250 V

1



SCREWDRIVER



No.	specification	
18101	4 x 75 mm	10
18102	4 x 100 mm	10
18103	5,5 x 100 mm	10
18104	5,5 x 125 mm	10
18105	6,5 x 100 mm	10
18106	6,5 x 125 mm	10
18107	8 x 160 mm	10
18108	10 x 160 mm	10



SCREWDRIVER AND BIT SET

- ⊖ S 3x75 · 4x75 · 6x100 · 8x150 mm
- ⊕ PH 1x75 · 2x100 mm
- ⊙ adapter 1/4"

- bits:
- ⊖ S 4 · 5 · 6 · 7 mm
 - ⊕ PH 1 · 2 · 3
 - ⊕ PZ 1 · 2 · 3
 - ⊕ T 10 · 15 · 20
 - ⊙ ↔ ⊕ adapter



No.	specification	
18418		10



PHILIPS SCREWDRIVER



No.	specification	
18201	0 x 75 mm	10
18202	1 x 75 mm	10
18203	2 x 100 mm	10
18204	3 x 150 mm	10



PHILIPS SCREWDRIVER

- ⊖ S 3x60 · 4x75 · 6x100 · 6x125 mm
- ⊕ PH 0x60 · 1x75 · 2x100 mm



No.	specification	
18400		10



POZIDRIVE SCREWDRIVER



No.	specification	
18301	0 x 75 mm	10
18302	1 x 75 mm	10
18303	2 x 100 mm	10
18304	3 x 150 mm	10



PHILIPS SCREWDRIVER

- ⊖ S 3x60 · 6x100 · 6x125 mm
- ⊕ PH 1x75 · 2x100 mm



No.	specification	
18401		1



FESTA

T SCREWDRIVER FOR BITS WITH RATCHET

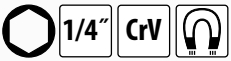

No. specification
18608

6



FESTA

SCREWDRIVER FOR BITS WITH RATCHET

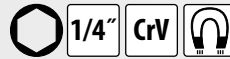

No. specification
18433

6



FESTA

SCREWDRIVER FOR BITS



No. specification
18110

12



FESTA

FLEXI SCREWDRIVER FOR HOSE CLAMPS



No. specification
18451

12



FESTA

SCREWDRIVER FOR BITS + 7 BITS

- ⊖ S 5 · 6 mm
- ⊕ PH 1 · 2 · 3
- ★ T 15 · 20

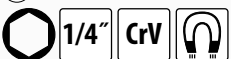

No. specification
18425

10



FESTA

FLEXI SCREWDRIVER FOR HOSE CLAMPS



No. specification
18450 7 mm

6



FESTA

SCREWDRIVER RATCHET + BITS

1/4" ↔ 1/4"

- S 3 · 4 · 5 · 6 · 7 · 5 L
- PH 1 · 2 · 3 · 1 L · 2 L
- PZ 1 · 2 · 3 · 1 L · 2 L
- H 2 · 2.5 · 3 · 4 · 5 · 6
- T 10 · 15 · 20 · 25 · 27 · 30
- SQ 0 · 1 · 2 · 3
- 1/4" 5 · 6 · 7 · 8 · 9 · 10 · 11 · 12 · 13 mm

1/4" 45x

No.	specification	
18419		6



FESTA

PRECISION SCREWDRIVER SET

- S 1,5x50 · 2x50 · 2,5x50 mm
- PH 000x50 · 00x50 · 0x50 mm

6x

No.	specification	
18416		6



FESTA

PRECISION ELECTRO SCREWDRIVER SET

- S 2,4 · 3,0 mm
- PH 0 · 1
- T 6 · 8

6x

No.	specification	
18415		10



FESTA

SCREWDRIVER + 20 BITS

- S 3 · 4 · 5 · 6 · 8 mm
- PH 0 · 1 · 2 · 3
- adapter + 5 · 6 · 7 · 8 · 9 · 10 · 11 · 12 · 13 mm

1/4" 20x

No.	specification	
18420		5



FESTA

PRECISION SCREWDRIVER SET TORX

- T 4 · 5 · 6 · 7 · 8 · 9 · 10x50 mm

7x

No.	specification	
18417		6



FESTA

SCREWDRIVER WITH PRECISION BITS

- S 1.5 · 2 · 2.5 · 3 · 3.5 mm
- PH 000 · 00 · 0 · 1
- PZ 0 · 1
- T 5 · 6 · 7 · 8 · 9 · 10 · 15 · 20
- H 0.9 · 1.3 · 2.0 · 2.5 · 3.0 · 4.0

50x

No.	specification	
18431		6



PRECIZION SCREWDRIVER SET

⊖ S 1,4 · 2,0 · 2,4 · 3,0 mm

⊕ PH 0 · 1

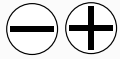

6x HOBBY



10

PRECIZION SCREWDRIVER SET

⊖ S 1,0 · 1,2 · 1,4 · 1,8 · 2,4 · 3,0 mm

⊕ PH 00 · 0 · 1

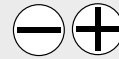

11x HOBBY



48

No.	specification
18408	10

No.	specification
18409	48



ANGLE ADAPTER FOR BITS 90°



18910



25

No.	specification
18910	25



BIT RATCHET



18435 93 mm



1

No.	specification
18435	93 mm

Stahlberg





bits – professional screwing attachments of high alloyed material S2

STAHLBERG producer

A trademark of world producer of screwing attachments with long-lasting experience in a field and with customers all over the world. During the production the latest technologies, uptill now the best developed materials and surfacings are used.

Forged attachments

cross-headed and flat bits are made by special technology of precise forging. It enables acheiving of high accuracy in shape, together with increasing in hardness in comparison with the bits by 20 %.



TiN layer

double applied on the surface of screwing spikes, it maximally increases the hardness, wipe resistance and frictional qualities prevent slipping out of the meshing.



Diamond grains

on the surface of the spike they really "bite" into the head of the wood screw or screw and enable to transfer maximum tightening torque. They are the best guarantee for staying in the meshing.



Nonskid grooves

on the working surfaces of the spikes made by forging are another very effective protection against the slipping out of the meshing.



NEW

Stahlberg
BIT PH

+

S2

2x

No.	specification	
18632A	PH2 x 25 mm	1
18633A	PH3 x 25 mm	1

NEW

Stahlberg
BIT PZ

*

S2

2x

No.	specification	
18636A	PZ1 x 25 mm	1
18637A	PZ2 x 25 mm	1
18638A	PZ3 x 25 mm	1

NEW

Stahlberg
BIT T

*

S2

2x

No.	specification	
18827A	T20 x 25 mm	1
18828A	T25 x 25 mm	1
18830A	T30 x 25 mm	1
18831A	T40 x 25 mm	1



Stahlberg

BIT PH DIAMANT



DIN 3128



MOQ 5



No.	specification	
18770	PH1 x 25 mm	5
18771	PH2 x 25 mm	5
18772	PH3 x 25 mm	5

Stahlberg

BIT PZ DIAMANT



DIN 3128



MOQ 5



No.	specification	
18775	PZ1 x 25 mm	5
18776	PZ2 x 25 mm	5
18777	PZ3 x 25 mm	5

Stahlberg

BIT S



S2



MOQ 5



No.	specification	
18620	S 3 x 25 mm	5
18621	S 4 x 25 mm	5
18623	S 5 x 25 mm	5
18625	S 6 x 25 mm	5
18627	S 7 x 25 mm	5
18628	S 8 x 25 mm	5

Stahlberg

BIT PH



S2



MOQ 5



No.	specification	
18630	PH0 x 25 mm	5
18631	PH1 x 25 mm	5
18632	PH2 x 25 mm	5
18633	PH3 x 25 mm	5
18634	PH4 x 25 mm	5

Stahlberg

BIT PZ



S2



MOQ 5



No.	specification	
18635	PZ0 x 25 mm	5
18636	PZ1 x 25 mm	5
18637	PZ2 x 25 mm	5
18638	PZ3 x 25 mm	5
18639	PZ4 x 25 mm	5

Stahlberg

BIT PH



S2



MOQ 25



No.	specification	
18685	PH2 x 25 mm	25

Stahlberg

BIT PZ



S2



MOQ 25



No.	specification	
18680	PZ2 x 25 mm	25

Stahlberg

BIT PH



S2



MOQ 10



No.	specification	
18640	PH1 x 70 mm	10
18641	PH2 x 70 mm	10

Stahlberg

BIT PZ



S2



MOQ 10



No.	specification	
18645	PZ1 x 70 mm	10
18646	PZ2 x 70 mm	10

Stahlberg

BIT PH



S2 TiN



MOQ 5



No.	specification	
18760	PH0 x 25 mm	5
18761	PH1 x 25 mm	5
18762	PH2 x 25 mm	5
18763	PH3 x 25 mm	5
18764	PH4 x 25 mm	5

Stahlberg

BIT PZ



S2 TiN



MOQ 5



No.	specification	
18765	PZ0 x 25 mm	5
18766	PZ1 x 25 mm	5
18767	PZ2 x 25 mm	5
18768	PZ3 x 25 mm	5
18769	PZ4 x 25 mm	5

Stahlberg

BIT S



S2 TiN



MOQ 5



No.	specification	
18750	S 3 x 25 mm	5
18751	S 4 x 25 mm	5
18753	S 5 x 25 mm	5
18755	S 6 x 25 mm	5

Stahlberg

BIT H



S2



MOQ 5



No.	specification	
18800	H 1,5 x 25 mm	5
18801	H 2,0 x 25 mm	5
18802	H 2,5 x 25 mm	5
18803	H 3,0 x 25 mm	5
18804	H 4,0 x 25 mm	5
18805	H 5,0 x 25 mm	5
18806	H 5,5 x 25 mm	5
18807	H 6,0 x 25 mm	5

Stahlberg

BIT TTA



S2



MOQ 5



No.	specification	
18835	TTa 5 x 25 mm	10
18836	TTa 6 x 25 mm	5
18837	TTa 7 x 25 mm	5
18838	TTa 8 x 25 mm	5
18839	TTa 9 x 25 mm	5
18840	TTa 10 x 25 mm	5
18841	TTa 15 x 25 mm	5
18842	TTa 20 x 25 mm	5
18843	TTa 25 x 25 mm	5
18844	TTa 27 x 25 mm	5
18845	TTa 30 x 25 mm	5
18846	TTa 40 x 25 mm	5
18847	TTa 45 x 25 mm	5

Stahlberg

BIT T



S2



MOQ 5



No.	specification	
18820	T5 x 25 mm	5
18821	T6 x 25 mm	5
18822	T7 x 25 mm	5
18823	T8 x 25 mm	5
18824	T9 x 25 mm	5
18825	T10 x 25 mm	5
18826	T15 x 25 mm	5
18827	T20 x 25 mm	5
18828	T25 x 25 mm	5
18829	T27 x 25 mm	5
18830	T30 x 25 mm	5
18831	T40 x 25 mm	5
18832	T45 x 25 mm	5

Stahlberg

BIT HTA



S2



MOQ 5



No.	specification	
18810	HTa 1,5 x 25 mm	5
18811	HTa 2,0 x 25 mm	5
18812	HTa 2,5 x 25 mm	5
18813	HTa 3,0 x 25 mm	5
18814	HTa 4,0 x 25 mm	5
18815	HTa 5,0 x 25 mm	5
18816	HTa 5,5 x 25 mm	5
18817	HTa 6,0 x 25 mm	5

Stahlberg

BIT T



S2



MOQ 3



No.	specification	
17980	T30 x 35 mm	3
17981	T40 x 35 mm	3

No.	specification	
17982	T45 x 35 mm	3
17983	T50 x 35 mm	3

Stahlberg

BIT SQ



S2



MOQ 5



No.	specification	
18850	SQ 0 x 25 mm	5
18851	SQ 1 x 25 mm	5
18852	SQ 2 x 25 mm	5
18853	SQ 3 x 25 mm	5

Stahlberg

BIT T



S2



MOQ 3



No.	specification	
17970	T20 x 75 mm	3
17971	T25 x 75 mm	3
17972	T30 x 75 mm	3
17973	T40 x 75 mm	3

No.	specification	
17974	T45 x 75 mm	3
17975	T50 x 75 mm	3
17976	T55 x 75 mm	3

Stahlberg

BIT SD



S2



MOQ 5



No.	specification	
18855	SD 6 x 25 mm	5
18856	SD 8 x 25 mm	5

Stahlberg

BIT TS



S2



MOQ 5



No.	specification	
18864	TS 4 x 25 mm	5
18865	TS 6 x 25 mm	5

Stahlberg

BIT



S2



MOQ 5



No.	specification	
18866	5/32 x 25 mm	5
18867	3/16 x 25 mm	5

Stahlberg

BIT TW



S2



MOQ 5



No.	specification	
18860	TW 1 x 25 mm	5
18861	TW 2 x 25 mm	5
18862	TW 3 x 25 mm	5
18863	TW 4 x 25 mm	5



Stahlberg
BIT XZN



No.	specification	MOQ
18870	M4 x 25 mm	5
18871	M5 x 25 mm	5
18872	M6 x 25 mm	5
18873	M8 x 25 mm	5
18874	M10 x 25 mm	5



Stahlberg
DRY WALL BIT



2x

No.	specification	MOQ
18795	PH 2 x 25 mm	24



Stahlberg
DRY WALL BIT



2x

No.	specification	MOQ
18796	PH 2 x 55 mm	24



Stahlberg
BIT ADAPTER

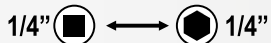

No.	specification	MOQ
18868	25 mm	5



Stahlberg
BIT ADAPTER

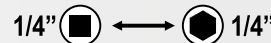

No.	specification	MOQ
18869	50 mm	5



Stahlberg
ADAPTER RATCHET 1/4' - BIT

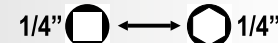

No.	specification	MOQ
18619		5



Stahlberg
MAGNETIC BIT HOLDER



No.	specification	MOQ
18600	1/4' x 60 mm	5



Stahlberg
MAGNETIC BIT HOLDER



No.	specification	MOQ
18797	1/4' x 60 mm	1



Stahlberg
MAGNETIC BIT HOLDER

· quick coupler

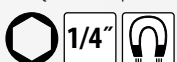

No.	specification	MOQ
18601	1/4' x 60 mm	5



Stahlberg
MAGNETIC BIT HOLDER

· quick coupler

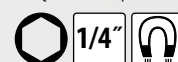

No.	specification	MOQ
18798	1/4' x 60 mm	1



Stahlberg

MAGNETIC BIT HOLDER

· with depth stop



No.	specification	MOQ
18602	1/4" x 60 mm	5



Stahlberg

MAGNETIC BIT HOLDER

· with depth stop



No.	specification	MOQ
18799	1/4" x 60 mm	1

NEW



Stahlberg

MAGNETIC BIT HOLDER



No.	specification	MOQ
18605	150 mm	25

NEW



FESTA

ADAPTER SDS+ FOR BIT 1/4"



No.	specification	MOQ
20743	75 mm	1



SLIDING BIT HOLDER



No.	specification	MOQ
18607	80 mm	25



Stahlberg

ADAPTER 1/4'

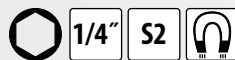

No.	specification	MOQ
18610	6 mm	5
18611	7 mm	5
18612	8 mm	5
18613	10 mm	5
18614	12 mm	5
18615	13 mm	5

ADAPTER - SADA

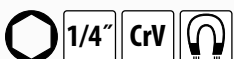

8x

No.	specification	MOQ
18618	6, 7, 8, 9, 10, 11, 12, 13 mm	12





BIT SET AND ADAPTERS

- 10x ⊕ 18630 PH0
- 10x ⊕ 18631 PH1
- 10x ⊕ 18632 PH2
- 10x ⊕ 18633 PH3
- 10x ⊕ 18635 PZ0
- 10x ⊕ 18636 PZ1
- 10x ⊕ 18637 PZ2
- 10x ⊕ 18638 PZ3
- 10x ⊕ 18761 PH1 TiN
- 10x ⊕ 18762 PH2 TiN
- 10x ⊕ 18763 PH3 TiN
- 10x ⊕ 18766 PZ1 TiN
- 10x ⊕ 18767 PZ2 TiN
- 10x ⊕ 18768 PZ3 TiN
- 10x ⊕ 18770 PH1 DIAMANT
- 10x ⊕ 18771 PH2 DIAMANT
- 10x ⊕ 18775 PZ1 DIAMANT
- 10x ⊕ 18776 PZ2 DIAMANT
- 10x ⊙ 18814 4,0HTa
- 10x ⊙ 18815 5,0HTa
- 10x ⊙ 18842 20TTa
- 10x ⊙ 18845 30TTa
- 10x ⊕ 18795 drywall bit
- 5x 18612 adapter 1/4" 8mm
- 5x 18613 adapter 1/4" 10mm
- 5x 18600 magnetic bit holder 1/4" 60mm
- 5x 18601 magnetic quick release bit holder 1/4" 60mm
- 5x 18602 magnetic bit holder - screwcap 1/4" 65mm



No. 18993 specification

1



BIT SET

- 10x ⊕ 18631 PH1
- 10x ⊕ 18632 PH2
- 10x ⊕ 18633 PH3
- 10x ⊕ 18636 PZ1
- 10x ⊕ 18637 PZ2
- 10x ⊕ 18638 PZ3
- 10x ⊕ 18761 PH1 TiN
- 10x ⊕ 18762 PH2 TiN
- 10x ⊕ 18763 PH3 TiN
- 10x ⊕ 18766 PZ1 TiN
- 10x ⊕ 18767 PZ2 TiN
- 10x ⊕ 18768 PZ3 TiN
- 10x ⊙ 18804 H 4
- 10x ⊙ 18805 H 5
- 10x ⊙ 18825 T 10
- 10x ⊙ 18826 T 15
- 10x ⊙ 18827 T 20
- 10x ⊙ 18828 T 25
- 10x ⊙ 18830 T 30
- 10x ⊙ 18831 T 40

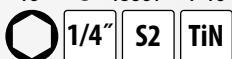

No. 18994 specification

1

FESTA

BIT SET



- ⊖ S 3 · 4 · 5 · 6
 - ⊕ PH 1 · 2 · 3
 - ✱ PZ 1 · 2 · 3
 - H 3 · 4 · 5 · 6
 - ★ T 10 · 15 · 20 · 25 · 27 · 30 · 40
 - ⊗ TTa 10 · 15 · 20 · 25 · 27 · 30 · 40
- magnetic quick release bit holder

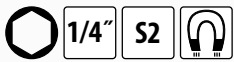

32x



No. specification

18905

10

FESTA

BIT SET



- ⊖ S 4 · 5 · 6
 - ⊕ PH 1 · 2 · 3
 - ✱ PZ 1 · 2 · 3
 - H 3 · 4 · 5 · 6
 - ★ T 10 · 15 · 20 · 25 · 27 · 30 · 40
 - ⊗ TTa 10 · 15 · 20 · 25 · 27 · 30 · 40
- magnetic quick release bit holder

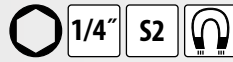

57x



No. specification

18906

6

FESTA

BIT SET

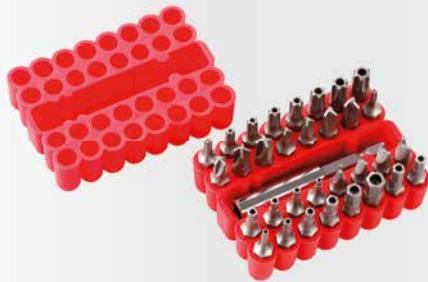

- ⊗ HTa 2 · 2.5 · 3 · 4 · 5 · 6
 - 5/32" · 9/64" · 1/8"
 - 7/64" · 3/32" · 5/64"
 - ⊙ SD 4 · 6 · 8 · 10
 - ⊕ TS 6 · 8 · 10
 - ⊖ TW 1 · 2 · 3 · 4
 - ⊗ TTa 8 · 10 · 15 · 20 · 25 · 27 · 30 · 35 · 40
- magnetic bit holder

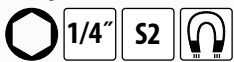

33x



No. specification

18900

10

FESTA

BIT SET



- ⊖ S 3 · 4 · 4.5 · 5 · 5.5 · 6 · 6.5 · 7 · 8
 - ⊕ PH 0 · 1 · 2 · 3
 - ✱ PZ 0 · 1 · 2 · 3
 - ⊖ SQ 0 · 1 · 2 · 3
 - ★ T 8 · 10 · 15 · 20 · 25 · 27 · 30 · 40 · 45
 - ⊗ TTa 8 · 10 · 15 · 20 · 25 · 27 · 30 · 35 · 40
 - H 1.5 · 2 · 2.5 · 3 · 4 · 5 · 5.5 · 6 · 8 mm
 - 1/16" · 5/64" · 3/32" · 7/64" · 1/8" · 9/64"
 - 5/32" · 3/16" · 7/32" · 1/4"
 - ⊙ HTa 2 · 2.5 · 3 · 4 · 5 · 6 mm
 - 5/64" · 3/32" · 7/64" · 1/8" · 9/64" · 5/32"
 - ⊙ SD 4 · 6 · 8 · 10
 - ⊕ TS 6 · 8 · 10
 - ⊖ TW 1 · 2 · 3 · 4
 - Ⓜ 2-wing 1 · 2 · 3
 - XZN 5 · 6 · 8
- magnetic bit holder
 „Y" holder
 1/4" DR screwdriver bit holder
 1/4" bit adapter: 25mm, 50mm

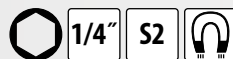

100x



No. specification

18909

24

FESTA

BIT SET

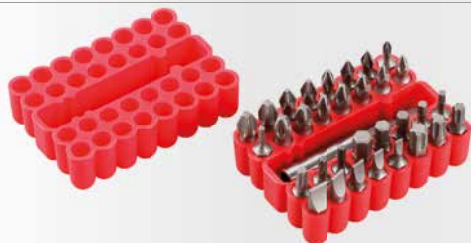

- ⊖ S 3 · 4 · 5 · 6 · 7
 - ⊕ PH 0 · 1 · 2 · 3
 - ✱ PZ 1 · 2 · 3
 - H 2 · 2.5 · 3 · 4 · 5 · 6
 - ★ T 10 · 15 · 20 · 25 · 30 · 40
- magnetic bit holder

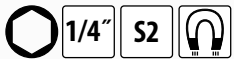

33x



No. specification

18901

10

BIT SET



- ⊖ S 4 · 5 · 6 · 7
- ⊕ PH 1 · 2 · 3
- ✱ PZ 1 · 2 · 3
- H 4 · 5 · 6
- ★ T 10 · 15 · 20 · 25
- SQ 1 · 2 · 3

S2

20x



BIT SET

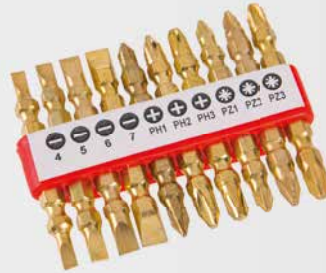

- ⊖ S 4 · 5 · 6 · 7
- ⊕ PH 1 · 2 · 3
- ✱ PZ 1 · 2 · 3

CrV TiN

10x



BIT SET



- ⊖ S 3 · 5 · 7
- ⊕ PH 1 · 2 · 3

magnetic bit holder

HOBBY

7x



No.	specification
18907	10

No.	specification
18440	10

No.	specification
18430	20



BIT SET

- ⊖ S 3 · 4 · 4,5 · 5 · 5,5 · 6 · 7
- ⊕ PH 1 · 2 · 3
- ✱ PZ 1 · 2 · 3
- H 2 · 3 · 4 · 5
- ★ T 20 · 30
- 1/4" 4 · 4,5 · 5 · 5,5 · 6 · 7 · 8 · 9 · 10
5/32" · 3/16" · 7/32" · 1/4" · 9/32" · 5/16" · 11/32" · 3/8" · 7/16"

magnetic screwdriver
bit holder
2 pcs adapter

1/4" CrV

41x



BIT SET

- ⊖ S 3 · 3,5 · 4 · 5,5
- ⊕ PH 0 · 1 · 2 · 3
- ✱ PZ 0 · 1 · 2 · 3
- H 3 · 4
- ★ T 10 · 15 · 20 · 25 · 27 · 30
- 1/4" 4 · 4,5 · 5 · 5,5 · 6 · 7 · 8 · 9 · 10 · 11 · 13

screwdriver holder 1/4"
magnetic bit holder

CrV 1/4"

40x



No.	specification
18916	10

No.	specification
18915	10

SET OF TOOLS

- ⊖ S 5 · 6 mm
- ⊕ PH 1 · 2
- H 3 · 4 · 5 · 6
- ★ T 15 · 20 · 25 · 30
- 1/4" 4 · 5 · 6 · 7 · 8 · 9 · 10 · 12 · 13 mm

75 mm 1/4" 1/4" 1/4"

1/4" CrV

23x



No.	specification
18421	10

SET OF TOOLS

- 120mm
- 125mm
- 115mm
- 150mm max. 19mm
- 9mm
- 1/4" 160mm
- 5 · 6 · 7 · 8 · 9 · 10 · 11 mm
- 1/4"
- 1/4"
- S 4 · 6 mm
- PH 1 · 2 · 3
- PZ 1 · 2
- H 4 · 5 · 6



35x

No. specification
17260



10

FESTA

SET OF TOOLS

- 1/2", 1/4"
- 1/4" · 4-5-6-7-8-9mm
- 1/2" · 10-12-13-14-17-19mm
- 1/4" · 4-4.5-5-5.5-6-7-8-9-10-11-12-13-14mm
- 1/2" · 12-13-14-15-16-17-18-19-20-21-22-24mm
- 1/2", 1/4"
- 1/4" · 1/4"
- 1/4" · 150mm
- 1/2" · 254mm
- 1/2", 1/4"
- 1/2" · 16-21mm
- 1/4" · 150mm
- 1/2" · E10-E12-E14-E16-E18-E20-E22-E24
- 1/4" · S 3 · 4 · 5 · 6
- 1/4" · PH 0 · 1 · 2
- 1/4" · PZ 0 · 1 · 2
- 1/4" · S 4 · 5,5 · 6,5
- 1/4" · PH 1 · 2 · 3
- 1/4" · PZ 2 · 3
- 1/4" · H 3 · 4 · 5 · 6
- 1/4" · T 8 · 10 · 15 · 20 · 25
- 1/4" · Tα 10 · 15 · 20 · 25 · 40
- 2 · 2,5 · 3 · 4 · 5 · 6 · 7 · 8 · 10mm
- 8-9-10-11-12-13-14-15-16-17-18-19mm
- S 4x100 · 6,5x150
- PH 2x100 · 3x150
- 180mm
- 160mm
- 160mm
- 250mm
- 300g



CrV S2 1/4" 1/2" 72T

122x

No. specification
17238 122 pcs



1

SET OF TOOLS

- 160 mm
- 160 mm
- 300 g
- 1/4" 45T
- 4 · 5 · 6 · 7 · 8 · 9 · 10 · 11 · 12 · 13 mm
- 1/4" 75 mm
- 1,5 · 2 · 2,5 · 3 · 4 · 5 · 6 · 8 · 10 mm
- S 3 · 4 · 5 · 6 mm
- PH 0 · 1 · 2 · 3
- PZ 0 · 1 · 2 · 3
- T 10 · 15 · 20 · 25
- H 3 · 4 · 5 · 6
- S 5x100 mm
- PH 1x100 · 2x100 mm
- S 2,5x50 mm
- PH 00x50 · 0x50 mm
- AC 100-250 V
- 200 mm max. 22 mm
- 10x11 · 12x13 · 14x15 · 16x17 mm
- 18 mm
- 2 m 13 mm



60x

No. specification

17259



5

SET OF TOOLS

- 1/4" 5 · 6 · 7 · 8 · 9 · 10 · 11 · 12 mm
- 1/4"
- 1/4"
- AC 230 V
- PH 0, SL 3
- 9x 1,5-10 mm
- 160 mm
- S 3 · 4 · 5 · 6 mm
- PH 0 · 1 · 2 · 3
- H 4 · 5
- PH 2x100, S 6x100
- 18 mm
- 1 m
- 300 g



32x

No. specification

17247



10

FESTA

HEX KEY SET

- H 1,5 mm
- H 2 mm
- H 2,5 mm
- H 3 mm
- H 4 mm
- H 5 mm
- H 6 mm
- H 8 mm
- H 10 mm



9x



No.	specification
18496	5

FESTA

HEAD HEX KEY SET

- H 1,5 mm
- H 2 mm
- H 2,5 mm
- H 3 mm
- H 4 mm
- H 5 mm
- H 6 mm
- H 8 mm
- H 10 mm



9x



No.	specification
18500	5

FESTA

HEX KEY SET - LONG

- H 1,5 mm
- H 2 mm
- H 2,5 mm
- H 3 mm
- H 4 mm
- H 5 mm
- H 6 mm
- H 8 mm
- H 10 mm



9x



No.	specification
18490	5

FESTA

HEAD HEX KEY SET

- H 1,5 mm
- H 2 mm
- H 2,5 mm
- H 3 mm
- H 4 mm
- H 5 mm
- H 6 mm
- H 8 mm
- H 10 mm



9x



No.	specification
18498	5

FESTA

HEAD HEX KEY SET

- 1/16"
- 5/64"
- 3/32"
- 1/8"
- 5/32"
- 3/16"
- 1/4"
- 5/16"
- 3/8"



9x



No.	specification
18493	6

FESTA

TORX SET

- T 10 mm
- T 15 mm
- T 20 mm
- T 25 mm
- T 27 mm
- T 30 mm
- T 40 mm
- T 45 mm
- T 50 mm



9x



No.	specification
18497	5

FESTA

HEAD HEX KEY SET - LONG

- H 1,5 mm
- H 2 mm
- H 2,5 mm
- H 3 mm
- H 4 mm
- H 5 mm
- H 6 mm
- H 8 mm
- H 10 mm



9x



No.	specification
18492	10

FESTA

TORX SET - LONG

- T 10 mm
- T 15 mm
- T 20 mm
- T 25 mm
- T 27 mm
- T 30 mm
- T 40 mm
- T 45 mm
- T 50 mm



9x

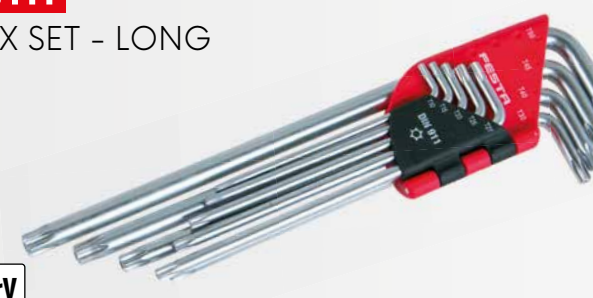

No.	specification
18491	5



FESTA

HEX KEY



No.	specification		
18548	8 mm	36 x 100 mm	1
18559	19 mm	70 x 180 mm	1
18562	22 mm	80 x 200 mm	1
18567	27 mm	100 x 250 mm	1
18572	32 mm	125 x 315 mm	1



FESTA

HEAD HEX KEY - LONG



No.	specification		
18575	1,5 mm	15 x 75 mm	1
18576	2 mm	17 x 81 mm	1
18577	2,5 mm	18 x 87 mm	1
18578	3 mm	20 x 96 mm	1
18579	4 mm	24 x 107 mm	1
18580	5 mm	30 x 120 mm	1
18581	6 mm	33 x 136 mm	1
18582	7 mm	34 x 144 mm	1
18583	8 mm	36 x 153 mm	1
18584	9 mm	38 x 155 mm	1
18585	10 mm	40 x 171 mm	1
18586	11 mm	40 x 230 mm	1
18587	12 mm	42 x 250 mm	1
18588	13 mm	45 x 260 mm	1
18589	14 mm	56 x 280 mm	1
18593	17 mm	61 x 290 mm	1



FESTA

HEX KEY - LONG



No.	specification		
18510	1,5 mm	15 x 75 mm	1
18511	2 mm	17 x 81 mm	1
18512	2,5 mm	18 x 87 mm	1
18513	3 mm	20 x 96 mm	1
18514	4 mm	24 x 107 mm	1
18515	5 mm	30 x 120 mm	1
18516	6 mm	33 x 136 mm	1
18518	8 mm	36 x 153 mm	1
18519	9 mm	38 x 155 mm	1
18520	10 mm	40 x 171 mm	1
18521	11 mm	40 x 230 mm	1
18522	12 mm	42 x 250 mm	1
18523	13 mm	45 x 260 mm	1
18524	14 mm	56 x 280 mm	1
18527	17 mm	61 x 290 mm	1



FESTA

TORX KEY



No.	specification	
18466	T7	1
18468	T9	1
18476	T45	1
18477	T50	1



FESTA

HEX KEY SET



No.	specification	
18508	1,5 · 2 · 2,5 · 3 · 4 · 5 · 6 mm	1



FESTA

T HANDLE INBUS KEY HEXAGONAL - SET

- 2 mm
- 2,5 mm
- 3 mm
- 4 mm
- 5 mm
- 6 mm
- 7 mm
- 8 mm
- 10 mm



9x



No.	specification	
18494		6



FESTA

T HANDLE KEY TORX - SET

- T 10
- T 15
- T 20
- T 25
- T 27
- T 30
- T 40
- T 45
- T 50



9x



No.	specification	
18495		6



HEX KEY SET



8x

No.	specification	
18499	2 · 2,5 · 3 · 4 · 5 · 6 · 8 · 10 mm	1



FESTA

T HANDLE KEY TORX



No.	specification		No.	specification	
17350	T 7	10	17357	T 27	10
17351	T 8	10	17359	T 40	10
17352	T 9	10	17360	T 45	10
17353	T 10	10	17361	T 50	10



HAMMERS and MALLETS



FESTA

HAMMER

· ash handle

DIN 1041

No.	specification	
19081	100 g	1
19082	200 g	1
19083	300 g	1
19084	400 g	1
19085	500 g	1
19086	600 g	1
19088	800 g	1
19090	1000 g	1
19092	1500 g	1
19095	2000 g	1



FESTA

MALLET

· ash handle

DIN 1041

No.	specification	
19096	3000 g	1
19097	4000 g	1
19098	5000 g	1
19106	6000 g	1
19108	8000 g	1
19109	10000 g	1

NEW



FESTA

MALLET

· ash handle

DIN 6475

No.	specification	
19041	1000 g	1
19042	1250 g	1
19043	1500 g	1
19044	2000 g	1



FESTA

MALLET

· ash handle

DIN 6475

No.	specification	
19045 NEW	3000 g	1
19046 NEW	4000 g	1
19074	5000 g	1
19075	6000 g	1
19076	8000 g	1
19077	10000 g	1



FESTA

HAMMER FIBERGLASS

· fiberglass handle

No.	specification		No.	specification	
19021	100 g	12	19026	600 g	6
19022	200 g	12	19028	800 g	6
19023	300 g	12	19030	1000 g	6
19024	400 g	12	19031	1500 g	6
19025	500 g	12	19032	2000 g	1



FESTA

MALETT FIBERGLASS

· circular wedge

No.	specification	
19034	3000 g	4
19036	4000 g	4



FESTA

MALETT FIBERGLASS

· fiberglass handle

DIN 6475

No.	specification	
19066	1000 g	4
19067	1250 g	4
19068	1500 g	4
19069	2000 g	2



FESTA

MALLET FIBERGLASS

DIN 6475

No.	specification	
19070	3000 g	4
19071	4000 g	4
19058	5000 g	4
19059	6000 g	2



HAMMER

· fiberglass handle

DIN 1041

No.	specification	
19001	100 g	12
19002	200 g	12
19003	300 g	6
19004	400 g	6
19005	500 g	6
19006	600 g	6
19008	800 g	6
19010	1000 g	6
19015	1500 g	6
19020	2000 g	6



MALETT

· circular wedge

DIN 6475

No.	specification	
19053	1000 g	6
19050	1250 g	6
19054	1500 g	6
19055	2000 g	6



MALETT

· circular wedge

DIN 6475

No.	specification	
19056	3000 g	6
19057	4000 g	6



FESTA

CLAW HAMMER FIBERGLASS

· fiberglass handle

No.	specification	
19064	450 g	6



FESTA

ROOF HAMMER FIBERGLASS

· fiberglass handle



No.	specification	
19061	600 g	6



FESTA

MASONRY HAMMER FIBERGLASS

· fiberglass handle

No.	specification	
19151	600 g	6



FESTA

CLAW HAMMER MONOLIT

No.	specification	
19063	450 g	6



FESTA

ROOF HAMMER MONOLIT



No.	specification	
19062	600 g	6



FESTA

MASONRY HAMMER MONOLIT

No.	specification	
19150	600 g	6



ROOF HAMMER



No.	specification	
19100	600 g	6



FESTA
CLAW HAMMER

No.	specification	
19065	600 g	6



FESTA
ROOF HAMMER



No.	specification	
19060	600 g	6



FESTA
MALETT

No.	specification	
19051	1000 g	6
19052	1500 g	6



FESTA
HAMMER - AXE

No.	specification	
19303	600 g	6



FESTA
MASONRY HAMMER

ash handle

No.	specification	
19149	44 mm	1



FESTA
MASONRY HAMMER

ash handle

No.	specification	
19124	24 mm	1
19136	36 mm	1
19148	48 mm	1



WELDING HAMMER



No.	specification	
19115	300 g	1



FESTA
ASH HANDLE FOR HAMMER

No.	specification	
61240	handle	1



ASH HANDLE FOR HAMMER



No.	specification	for axe	
61320	26 cm	19081	10
61321	28 cm	19082	10
61322	30 cm	19083	10
61323	31 cm	19084	10
61324	32 cm	19085	10



ASH HANDLE FOR MALETT



No.	specification	for malett	
61330	80 cm	19074, 19075	10
61331	90 cm	19076, 19077	10



CONICAL CIRCULAR WEDGE

No.	specification	
19430	6 mm	10
19431	8 mm	10
19432	10 mm	10
19433	12 mm	10
19434	14 mm	10
19435	16 mm	10



FORGED WEDGE



No.	specification	
19440	narrow	10
19441	middle	10
19442	wide	10
19443	wide S	10



FESTA

STEEL WEDGE



No.	specification	
19398	20 x 25 x 5 mm	1
19399	30 x 40 x 5 mm	1

3x



FESTA

WOODEN MALLET

· beech wood



No.	specification			
19202	Ø 60 x 120 mm	350 g		1



FESTA

WOODEN MALLET

· beech wood



No.	specification			
19200	80 x 60 mm	520 g		1



FESTA

RUBBER MALLET

· ash handle



No.	specification			
19245	Ø 55 mm	400 g		1
19246	Ø 60 mm	800 g		1
19247	Ø 70 mm	1000 g		1
19248	Ø 95 mm	2000 g		1
19249	Ø 115 mm	3000 g		1



FESTA

RUBBER MALLET

· fiberglass handle



No.	specification			
19270	Ø 55 mm			6
19271	Ø 65 mm			6
19272	Ø 90 mm			6



FESTA

RUBBER MALLET



No.	specification			
19255	Ø 55 mm			6
19265	Ø 65 mm			6
19290	Ø 90 mm			6



FESTA

WHITE RUBBER MALLET



No.	specification			
19293	NEW Ø 55 mm			6
19294	Ø 65 mm			6
19295	Ø 90 mm			6



No.	specification			
19254	Ø 65 mm			6



RUBBER MALLET



No.	specification	
19251	Ø 55 mm 400 g	12
19252	Ø 65 mm 700 g	6
19253	Ø 90 mm 1300 g	4



BRASS MALETT

· fiberglass handle

No.	specification	
19211	Ø 30 mm 500 g	1



SILICON HAMMER

No.	specification	
19297	Ø 35 mm	12



NYLON MALLET

· fiberglass handle



No.	specification	
19209	Ø 34 mm	6



MALLET WITH REPLACEABLE HEADS

· PP - 97 Shore A



· TPE - 90 Shore A



· TPU - 92 Shore A



· TPU - 88 Shore A



TPU - 95 Shore A



TPE - 90 Shore A



TPU - 92 Shore A



TPE - 90 Shore A



No.	specification	
19208	Ø 40 mm	1



FESTA

AXES



FESTA

AXE

DIN 5131 **DIN 7294**

- ash handle
- circular wedge

No.	specification		No.	specification	
19380	600 g	1	19384	1400 g	1
19381	800 g	1	19385	1600 g	1
19382	1000 g	1	19387	2000 g	1
19383	1250 g	1			



FESTA

CANPERTERS AXE

- ash handle

No.	specification	
19340	700 g	22



FESTA

AXE

- ash handle
- circular wedge

DIN 5129

No.	specification	
19389	3000 g	1
19388	4000 g	1



FESTA

SPLITTING AXE

- ash handle
- circular wedge

DIN 7294

No.	specification	
19391	2000 g	1



AXE

No.	specification	
19306	600 g	24
19308	800 g	24
19310	1000 g	24
19312	1250 g	12
19314	1500 g	12



ASH HANDLE FOR AXE



No.	specification	for axe	
61340	36 cm	19380	10
61341	40 cm	19381, 19340	10
61342	50 cm	19382	10
61343	70 cm	19383, 19384	10

No.	specification	for axe	
61344	80 cm	19385, 19391	10
61345	90 cm	19387	10
61346	90 cm	19388, 19389	10



FESTA

AXE FIBERGLASS

· fiberglass handle

No.	specification	
19326	600 g	6
19328	800 g	24
19330	1000 g	12



FESTA

CAMP AXE FIBERGLASS

· fiberglass handle

No.	specification	
19301	500 g	6



FESTA

SPLITTING AXE FIBERGLASS

· fiberglass handle

No.	specification	
19392	1000 g	6



FESTA

SPLITTING AXE FIBERGLASS

· fiberglass handle

No.	specification	
19390	2000 g	6



FESTA

AXE FIBERGLASS

· fiberglass handle

No.	specification	
19370	3000 g	4
19371	4000 g	4



Black Eagle

AXE



No.	specification	
19356	1200 g	5
19357	1800 g	1



SPLITTING MANDREL SDS+



No.	Specification	
19393	∅ 32 x 132 mm	10
19374	∅ 42 x 145 mm	10



SPLITTING WEDGE

No.	specification	
19397	2000 g 55 x 210 x 45 mm	10
19465	2500 g 65 x 230 x 45 mm	10



SPLITTING WEDGE FOUR-SPOKE

No.	specification	
19469	2500 g 165 x 87 mm	10



SPLITTING WEDGE



No.	specification	
19462	175 x 65 x 20 mm	1
19463	230 x 70 x 30 mm	1
19464	240 x 75 x 40 mm	1



SPLITTING WEDGE

No.	specification	
19394	1000 g 35 x 180 x 40 mm	6
19395	2000 g 40 x 255 x 55 mm	6
19396	2500 g 40 x 260 x 55 mm	8



FESTO

OVAL PULLER

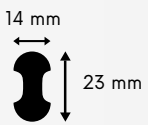

No.	specification	
19424	400 mm	6
19425	600 mm	6
19426	800 mm	6
19427	1000 mm	6

CROWBAR

No.	specification	
19416	600 mm Ø 16 mm	4
19422	800 mm Ø 16 mm	4
19421	1000 mm Ø 18 mm	4



CROWBAR

No.	specification	
19423	380 x 35 x 6 mm	1

NAIL PULLER

No.	specification	
19415	300 mm Ø 15 mm	6



FESTA
FLAT CHISEL

CrV

No.	specification	the tip width	
19406	300 mm	25 mm	5
19407	400 mm	30 mm	5



FESTA
POINT CHISEL

CrV

No.	specification	the tip width	
19408	250 mm		5
19409	350 mm		5



FESTA
FLAT CHISEL

CrV

No.	specification	the tip width	
19460	300 mm	25 mm	5
19470	400 mm	30 mm	5



POINT CHISEL

No.	specification	the tip width	
19400	250 mm		5
19403	350 mm		6



FLAT CHISEL

No.	specification	the tip width	
19401	250 mm	19 mm	6
19404	350 mm	22 mm	6



FLAT CHISEL

No.	specification	the tip width	
19402	250 mm	50 mm	2
19405	350 mm	50 mm	6



FESTA
FLAT CHISEL

CrV

No.	specification	the tip width	
19410	200 mm	20 mm	10
19411	250 mm	25 mm	10
19412	300 mm	25 mm	10
19418	400 mm	25 mm	5
19419	500 mm	25 mm	5



FLAT CHISEL

CrV

No.	specification	the tip width	
19436	200 mm	20 mm	15



CHISELS



FESTA

CHISEL

CrV



No.	specification		No.	specification	
19490	6 mm 275 mm	6	19496	18 mm 280 mm	6
19491	8 mm 275 mm	6	19497	20 mm 280 mm	6
19492	10 mm 275 mm	6	19498	22 mm 280 mm	6
19493	12 mm 275 mm	6	19499	25 mm 280 mm	6
19494	14 mm 275 mm	6	19501	32 mm 290 mm	6
19495	16 mm 275 mm	6	19502	38 mm 290 mm	6

CHISEL SET



4x

No.	specification	
19450		20

FESTA

CHISEL SET WITH SHARPPENER STONE

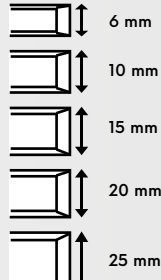

CrV 5x



No.	specification	
19451		10

FESTA

CHISEL SET



CrV 4x



No.	specification	
19457		10



FESTA

MULTIFUNCTION CHISEL

INOX



No.	specification	
16231	20 80 mm	12

CHISEL SET



4x

No.	specification	
19455		30



FESTA

CHISEL SET

CrV

8x



No.	specification	
19458	365 125mm	1



JACK - PLANE



No.	specification	
19510	220 x 65 x 130 mm, knife 48 mm	1



CHISEL SET

CrV

12x



No.	specification	
19459		5



JACK - PLANE



No.	specification	
19515	200 x 55 x 130 mm, knife 39 mm	1



JACK - PLANE



No.	specification	
19520	225 x 27 x 155 mm, knife 27 mm	1



TINMANS SET

7x

No.	specification	
19110		5



FESTA®







STAPLERS



FESTA®





STAPLE GUN 5 IN 1

-  | 6 - 14 mm
23960 - 23964
23760 - 23764,
23906 - 23914
-  | 10 - 14 mm
23965
-  | 15 mm
23966
-  | 15 mm
23967

No.	specification	
23927		6

FESTA®

STAPLE GUN 4 IN 1



-  | 6 - 14 mm
23960 - 23964
-  | 12 mm
23965
-  | 14 mm
23966
-  | 14 mm
23967



No.	specification	
23924		12

FESTA®

STAPLE GUN 3 IN 1

-  | 6 - 14 mm
23960 - 23964
-  | 14 mm
23966
-  | 14 mm
23967



No.	specification	
23923		12

FESTA®

STAPLE GUN

-  53 | 4 - 14 mm
23904 - 23914,
23760 - 23765



No.	specification	
23925	4 - 14 mm with lock out	20

FESTA®

STAPLES EXTRACTOR



No.	specification	
23945		25

STAPLE GUN

 53 | 4 - 14 mm
23760 - 23765,
23904 - 23914



No.	specification	
23800		20

STAPLE GUN

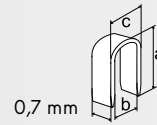

 $\alpha=9-11 \text{ mm}, b=5,5\text{mm}, c=6,4\text{mm}$



No.	specification	
23920		4



STAPLE HAMMER

 | 6 - 10 mm
23960 - 23962



No.	specification	
23922		10

STAPLE HAMMER

 | 6 - 10 mm
23960 - 23962



No.	specification	
23928		6



STAPLES EXTRA

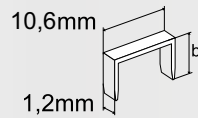

No.	specification	
23960	b=6 mm, 1000 pcs	50
23961	b=8 mm, 1000 pcs	50
23962	b=10 mm, 1000 pcs	50
23963	b=12 mm, 1000 pcs	50
23964	b=14 mm, 1000 pcs	50

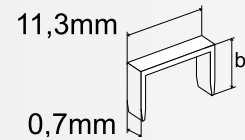

STAPLES - TYPE 53



No.	specification	
23904	b=4 mm 1000 pcs	200
23906	b=6 mm 1000 pcs	200
23908	b=8 mm 1000 pcs	200
23910	b=10 mm 1000 pcs	200
23912	b=12 mm 1000 pcs	200
23914	b=14 mm 1000 pcs	200



STAPLES

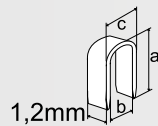

No.	specification	
23965	$\alpha=12 \text{ mm}, b=6,5 \text{ mm}, c=7,5 \text{ mm}, 1000 \text{ TW}$	50



NAILS



No.	specification	
23966	nails 14 mm 1000 TW	100



NAILS



No.	specification	
23967	nails 14 mm 1000 TW	100

STAPLES - TYPE 53



No.	specification	
23760	b=4 mm 2000 pcs	10
23761	b=6 mm 2000 pcs	10
23762	b=8 mm 2000 pcs	10
23763	b=10 mm 2000 pcs	10
23764	b=12 mm 2000 pcs	10

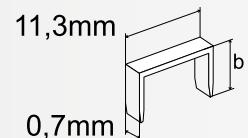



CLAMPS AND VICES

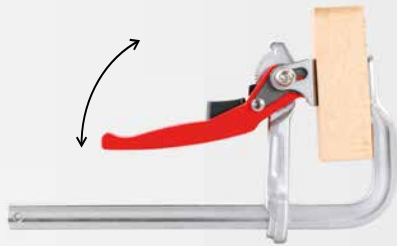

FESTA

QUICK GRIP CLAMP

• drop forged

No.	specification	
23560	200 x 80 mm	1
23561	300 x 100 mm	1
23562	400 x 100 mm	1
23563	500 x 120 mm	1



No.	specification	
23564	600 x 120 mm	1
23565	800 x 120 mm	1
23566	1000 x 120 mm	1



FESTA

QUICK GRIP CLAMP



No.	specification	
23570	100 x 80 mm	1
23571	160 x 80 mm	1
23572	200 x 80 mm	1
23573	250 x 80 mm	1
23574	300 x 80 mm	1



FESTA

STEEL CLAMP



No.	specification	
23670	150 x 105 mm	1
23671	200 x 105 mm	1
23672	250 x 105 mm	1
23673	300 x 105 mm	1
23674	350 x 105 mm	1
23675	400 x 175 mm	1

No.	specification	
23676	500 x 175 mm	1
23677	600 x 175 mm	1
23678	700 x 175 mm	1
23679	800 x 175 mm	1
23680	1000 x 175 mm	1
23681	1250 x 175 mm	1

No.	specification	
23682	1500 x 175 mm	1
23683	1750 x 175 mm	1
23684	2000 x 175 mm	1
23685	2200 x 175 mm	1



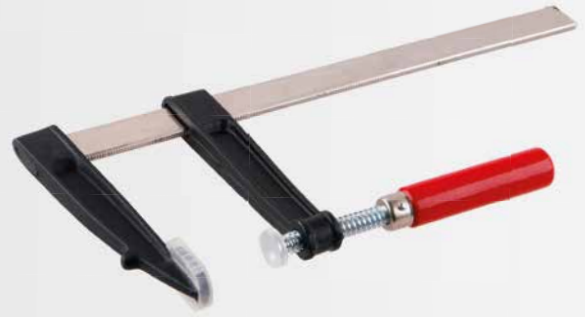

CLAMP

DIN 5117

No.	specification	
23506	300 x 120 mm	10
23507	500 x 120 mm	10
23508	800 x 120 mm	6

CLAMP

No.	specification		No.	specification	
23515	150 x 50 mm	50	23530	300 x 50 mm	50
23520	200 x 50 mm	50	23531	300 x 120 mm	20
23525	250 x 50 mm	50	23551	500 x 120 mm	10



FESTA

QUICK GRIP CLAMP

No.	specification	
23625	200 mm	6
23626	300 mm	6
23628	450 mm	6
23630	600 mm	6
23632	760 mm	6

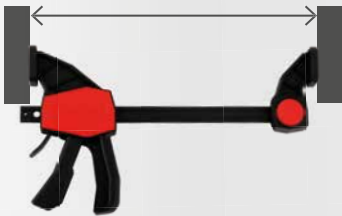

FESTA

QUICK GRIP CLAMP

No.	specification	
23585	150 mm	6
23587	300 mm	6
23589	450 mm	6
23591	600 mm	6



RATCHET CLAMP

span 80 mm

No.	specification	
23605	9' 230 mm	6

PLASTIC CLAMP

No.	specification	
23600	4', span 40 mm	20
23601	6', span 50 mm	12
23602	9', span 80 mm	20

CLAMP SET

3x

No.	specification	
23620	25 mm, 50 mm, 75 mm	10



FESTA

VICE

· hardened jaw

No.	specification	
23410	100 mm	1
23411	125 mm	1
23412	150 mm	1



SWIVEL VICE

· hardened jaw

No.	specification	
23415	100 mm	1
23416	125 mm	1
23417	150 mm	1



SWIVEL VICE

No.	specification	
23407	65 mm	10

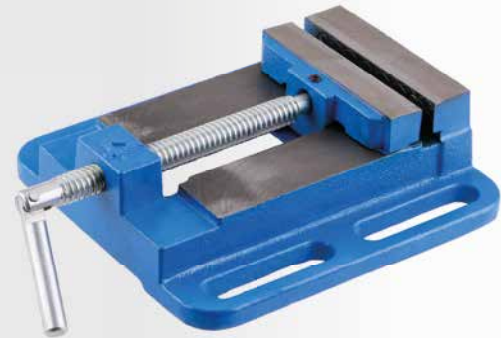

DRILL MACHINE VICE

· hardened jaw

No.	specification	
23400	18 80 mm	10
23401	22 100 mm	10
23402	24 125 mm	5

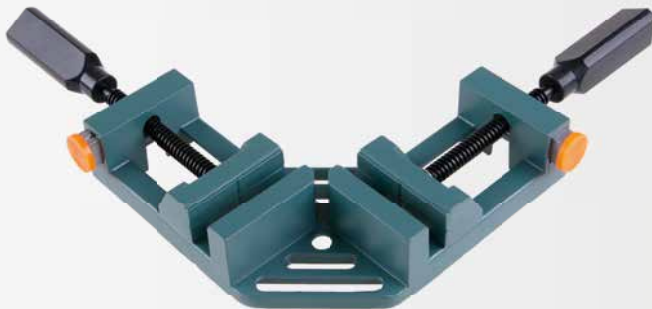

VICE ALU WITH SWIVEL TABLE 90°

ALU

· range 0 - 65 mm

No.	specification	
23420	65 mm	20



VICE ALU WITH SWIVEL BASE 360°

ALU

No.	specification	
23406	80 mm	24

NEW



WORK BENCH

· max. load 100 kg

No.	Specification
23655	100 x 50 x 84 cm



1



WORK BENCH

· ideal for cellars

No.	specification
23660	



1



MULTIFUNCTIONAL WORK BENCH

No.	specification
23650	



1

NEW



FESTA

FOLDING SAW HORSE

· max. load: 590 kg

No. Specification
23657



1

NEW



FESTA

PORTABLE STAND VISE

· clamping range: 0 - 95 cm
· max. load: 250 kg

No. Specification
37553



1

FESTA®

RIVETER



FESTA®
RIVETER

Cr-Mo

- Ø 2,4 mm
- Ø 3,2 mm
- Ø 4,0 mm
- Ø 4,8 mm



No. specification
24007 200 mm

1



FESTA®
RIVETER

Cr-Mo

- Ø 2,4 mm
- Ø 3,2 mm
- Ø 4,0 mm
- Ø 4,8 mm



No. specification
24010 250 mm

12



FESTA

RIVETER

Cr-Mo

- Ø 2,4 mm
- Ø 3,2 mm
- Ø 4,0 mm
- Ø 4,8 mm
- Ø 6,4 mm



No.	specification	
24017	280 mm	1



FESTA

RIVETER

Cr-Mo

- Ø 2,4 mm
- Ø 3,2 mm
- Ø 4,0 mm
- Ø 4,8 mm
- Ø 6,4 mm



No.	specification	
24015	530 mm	1



FESTA

RIVETER

Cr-Mo

- Ø 2,4 mm
- Ø 3,0 mm
- Ø 3,2 mm
- Ø 4,0 mm
- Ø 4,8 mm



No.	specification	
24030	260 mm	24



FESTA

RIVETER

- adjustable head of riveter
- 2 positions

Cr-Mo



No.	specification	
24002	260 mm	6

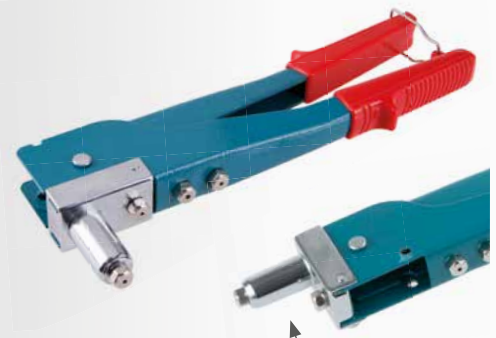

FESTA

RIVETER WITH MULTI-SIZE BLOCKER

Cr-Mo

- Ø 2,4 mm
- Ø 3,2 mm
- Ø 4,0 mm
- Ø 4,8 mm



No.	specification	
24006	250 mm	12



RIVETER

Cr-Mo

- Ø 2,4 x 6 mm
- Ø 3,2 x 6 mm
- Ø 4,0 x 6 mm
- Ø 4,8 x 6 mm



No.	specification	
24005	260 mm	5



FESTA

RIVETER

Cr-Mo



No.	specification	
24020	290 mm	8



RIVETER



No.	specification	
24001	260 mm	6



RIVETER



No.	specification	
24000	250 mm	24

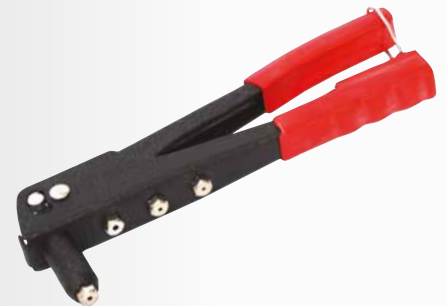

FESTA

RIVETER

Cr-Mo

- M3
- M4
- M5
- M6
- M8
- M10



No.	specification
24036	330 mm



1

FESTA

RIVETER

Cr-Mo

- M3
- M4
- M5
- M6



No.	specification
24035	200 mm



1

FESTA

RIVETER HEAD

· suitable for 24035, 24036

Cr-Mo



No.	specification	
24038	M3	1
24039	M4	1
24040	M5	1
24041	M6	1
24042	M8	1
24043	M10	1



ALU RIVET

ALU

50x



No.	specification	
23970	3,2 x 6 mm	25
23971	3,2 x 8 mm	25
23972	3,2 x 10 mm	25
23973	3,2 x 12 mm	25
23974	3,2 x 14 mm	25
23975	4,0 x 6 mm	25
23976	4,0 x 8 mm	25
23977	4,0 x 10 mm	25
23978	4,0 x 12 mm	25
23979	4,0 x 14 mm	25
23985	4,8 x 6 mm	25
23986	4,8 x 8 mm	25
23987	4,8 x 10 mm	25
23988	4,8 x 12 mm	25
23989	4,8 x 14 mm	25

NUT RIVETING,
20 PCS

ALU

20x



No.	specification	
23950	M3 x 9 mm	20
23951	M4 x 11 mm	20
23952	M5 x 12 mm	50
23953	M6 x 14 mm	50
23954	M8 x 16,5 mm	25
23955	M10 x 18 mm	20





FESTA

CONNECTING PLIERS FOR PROFILES



No.	specification	
17187	350 mm	6

FESTA

CONNECTING PLIERS FOR PROFILES



No.	specification	
17188	250 mm	12



RIVETER FOR PLUG



No.	specification	
17189	255 mm	12



TWO LEGS PULLER



No.	max. průměr	depth	
23734	Ø 100 mm	50-95 mm	1
23735	Ø 150 mm	100-150 mm	1
23736	Ø 200 mm	110-190 mm	1

THREE - LEG PULLER



No.	max. diameter	depth	
23730	Ø 100 mm	50-95 mm	2
23731	Ø 150 mm	100-150 mm	2
23732	Ø 200 mm	110-190 mm	2

**FESTA****WELDING INVERTER TIG/MMA 160 A**

Voltage / frequency:	230 V / 50 Hz
Voltage free:	55 V
Regulatory range welding currents:	10 - 160 A
Diameter of electrode:	1,5 - 4,0 mm
Working cycle:	TIG- 160 A / 60%, MMA - 140 A / 60%
Protection class:	IP 21
Type of welding:	TIG/MMA
Dimensions:	405 x 165 x 270 mm
Technology:	Anti-stick, Arc-force, Hot start, Lift TIG
Weight:	6 kg

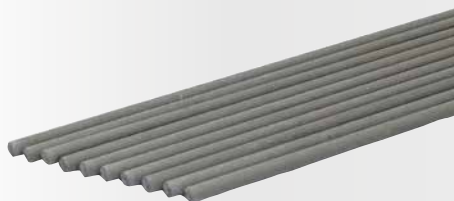

No.	specification	
70040	Welding inverter TIG/MMA 160A	1
70045	Spare welding cables	1
70046	Spare heating torch TIG	1

**WELDING RUTILE ELECTRODE**

certificated

No.	specification	množství	
70021	Ø 2,0 x 300 mm	10 pcs	1
70020	Ø 2,0 x 300 mm	2,5 kg	8
70026	Ø 2,5 x 300 mm	10 pcs	1
70025	Ø 2,5 x 300 mm	2,5 kg	8
70033	Ø 3,2 x 350 mm	10 pcs	1
70032	Ø 3,2 x 350 mm	5 kg	4

**WELDING BASIC ELECTRODE**

certificated

No.	specification	množství	
70030	Ø 2,0 x 300 mm	2,5 kg	1
70031	Ø 2,0 x 300 mm	5 kg	1
70035	Ø 2,5 x 300 mm	2,5 kg	8
70036	Ø 2,5 x 300 mm	10 pcs	1
70037	Ø 3,2 x 350 mm	5 kg	5
70038	Ø 3,2 x 350 mm	10 pcs	1



FESTA

SELFDARKENING WELDING HELMET

View size:	98 x 80 mm
Lens reaction time	1/25 000 s
Darkening	DIN 5-8 / 9-13
UV/IR protection	DIN 16
Optical class	1 1 1 2
Working cycle:	4
Power supply:	Solar cell + replaceable battery CR2450
Operating mode	Welding, grinding



CE EN
379

No.	specification	
70064	active	1
70066	replacement protective plexiglass	1



FESTA

SELFDARKENING WELDING HELMET



No.	specification	
70063	active	4



SELFDARKENING WELDING HELMET

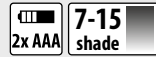

No.	specification	
70060	active	4



WELDING HELMET



No.	specification	
70061		4



WELDING GOGGLES



No.	specification	
70062		1



REPLACEMENT PROTECTIVE GLASS FOR WELDING HELMET

2x

No.	specification	
70065	113 x 80 mm	20



WELDING HAMMER



No.	specification	
19115	300 g	1



ELECTRODE HOLDER



No.	specification	
70070	300 A	1



WELDING PLIERS



No.	specification	
70075	300 A	1



FESTA

MAGNETIC WELDING HOLDER



No.	specification	nosnost	
70096	150 x 130 x 30 mm · 45°, 90°, 135°	25 kg	10



MAGNETIC WELDING HOLDER



No.	specification	nosnost	
70090	85 x 85 mm · 45°, 90°	9 kg	10



MAGNETIC WELDING HOLDER



No.	specification	nosnost	
70093	95 x 64 mm · 30°, 45°, 60°, 75°, 90°	9 kg	10
70094	120 x 90 mm · 30°, 45°, 60°, 75°, 90°	18 kg	10
70095	137 x 110 mm · 30°, 45°, 60°, 75°, 90°	27 kg	10



MAGNETIC WELDING HOLDER



No.	specification	nosnost	
70091	95 x 109 x 25 mm · 45°, 90°, 135°	13 kg	10
70092	130 x 150 x 32 mm · 45°, 90°, 135°	22 kg	5



THREAD ROD STANLESS

DIN 976 **INOX**

4.8 · strength class

No.	specification	
55311	M 5 1 m	150
55313	M 8 1 m	50
55314	M 10 1 m	25
55315	M 12 1 m	20
55316	M 14 1 m	15
55317	M 16 1 m	15
55318	M 18 1 m	10
55319	M 20 1 m	10

THREAD ROD

DIN 975 **Zn**

4.8 · strength class

No.	specification	
55040	M 4 1 m	200
55050	M 5 1 m	150
55060	M 6 1 m	100
55080	M 8 1 m	50
55100	M 10 1 m	20
55120	M 12 1 m	20
55140	M 14 1 m	15
55160	M 16 1 m	15
55180	M 18 1 m	10
55200	M 20 1 m	10
55220	M 22 1 m	5
55240	M 24 1 m	5
55300	M 30 1 m	5

THREAD ROD

DIN 975

4.8 · strength class

No.	specification	
55041	M 4 1 m	200
55051	M 5 1 m	150
55181	M 18 1 m	10
55201	M 20 1 m	10
55221	M 22 1 m	5
55301	M 30 1 m	5

NEW



before after



FESTA

EDGE CLEANER

Ø 3 – 19 mm

1/4"



No.	Specification	
16321		5



NUT

DIN 934 **Zn**

4.8 · strength class



No.	specification	
55350	M 4	100 pcs
55351	M 5	100 pcs
55352	M 6	100 pcs
55353	M 8	100 pcs
55354	M 10	100 pcs
55355	M 12	100 pcs
55356	M 14	100 pcs
55357	M 16	100 pcs
55358	M 18	100 pcs
55359	M 20	10 pcs
55360	M 22	10 pcs
55361	M 24	10 pcs
55362	M 30	10 pcs

WASHER

DIN 440R **Zn**



No.	specification	
55331	M 5	100 pcs
55332	M 6	100 pcs
55333	M 8	100 pcs
55334	M 10	100 pcs
55335	M 12	100 pcs
55336	M 14	100 pcs
55337	M 16	100 pcs
55339	M 20	10 pcs
55340	M 22	10 pcs
55341	M 24	10 pcs
55342	M 30	10 pcs



FESTA

COMPRESSOR 6 L - OILLESS



Voltage / frequency:	230 V / 50Hz
Power consumption:	1,2 kW (1,5HP)
Tank volume :	6 l
Max. pressure:	8 Bar
Speed:	3900 min.
Suction power:	180 l/min.
Filling performance:	116 l/min.
Weight:	10 kg



No. 35360



COMPRESSOR 24 L - OILLESS



Output:	1100 W
Power supply:	230 V / 50Hz
Run without load:	2850 min-1
Work pressure:	8 bar
Free Air Intake:	160 l / min
Type:	without oil
Storage capacity:	24 L
Weight:	23 kg



No. specification 35361 1,1 kW, 24 l



COMPRESSOR 24 L



Output:	1500 W
Power supply:	230 V / 50Hz
Run without load:	2850 min-1
Work pressure:	8 bar
Free Air Intake:	200 l / min
Type:	oleic
Storage capacity:	24 L
Weight:	24 kg



No. specification 35362 1,5 kW, 24 l





FESTA

COMPRESSOR SET

5x

- spray gun with bottom reservoir
- bladder gun with nanometer
- spray gun with top shelf
- blowing guns
- hose with quick couplings



No.	specification
48001	1

FESTA

COMPRESSOR SET

3x

- blow guns with manometer
- blow guns
- hose with quick couplings



No.	specification
48002	1



FESTA

SPRAY GUN



No.	specification
48015	lower



FESTA

UNDER COATING GUN



No.	specification
48036	lower



FESTA
SPRAY GUN

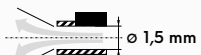

No.	specification	
48020	upper	1



FESTA
SPRAY GUN



No.	specification	
48021	upper	1
48047	spare nozzle ø 1,7 mm	1



FESTA
SPRAY GUN



No.	specification	
48022	upper	1
48046	spare nozzle ø 1,5 mm	1



FESTA
BLOW GUN

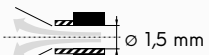

No.	specification	
48030	lower	1



SPRAY GUN FOR PAINTS AND PLASTERS

- 4 - 6 Bar
- 5 l
- nozzle Ø 4; 6; 8 mm

No.	specification	
48037		1



FESTA
BLOW GUN

No.	specification	
48005	short	25



FESTA
BLOW GUN

No.	specification	
48006	medium	25



FESTA
BLOW GUN

No.	specification	
48007	long	25



FESTA

RINSER GUN WITH MANOMETR

No.	specification	
48010		1



FESTA

GUN HOSE INCLUDED CONNECTORS

· max. 20 Bar

No.	specification	
48031	5 m	1
48032	10 m	1
48033	15 m	1
48034	20 m	1



FESTA

GUN HOSE INCLUDED CONNECTORS

No.	specification	světlost	
48043	5 m	8 atm	1



FESTA

GUN HOSE INCLUDED CONNECTORS

No.	specification	světlost	
48040	5 m	8 atm	1
48041	10 m	8 atm	1
48042	15 m	8 atm	1



FESTA

FILTER

· max. pressure 10 bar

No.	specification	
48008	G 1/4'	1



FESTA

PRESSURE REGULATOR

· working pressure 0 - 10 bar

No.	specification	
48009	G 1/4'	1



FESTA

SPARE NOZZLE

· suitable for 48021

No.	specification	
48047	nozzle Ø 1,7 mm	1



FESTA

SPARE NOZZLE

· suitable for 48022

No.	specification	
48046	nozzle Ø 1,5 mm	1



TABLE OF WHITWORTHS PIPE THREADS

SIZE OF THREADS IN INCH	MAX. OUTER Ø OF THREADS
1/8	9,728
1/4	13,157
3/8	16,662
1/2	20,955
3/4	26,441
1	33,249



HOSE CONNECTOR WITH THREAD

No.	specification	
48075	1/4' out	10
48076	3/8' out	10
48077	1/2' out	10
48095	1/4' in	10
48096	3/8' in	10
48097	1/2' in	10



HOSE CONNECTOR

No.	specification	
48070	1/4' - 6 mm	10
48071	3/8' - 9 mm	10
48072	1/2' - 13 mm	10



ADAPTER WITH THREAD

No.	specification	
48080	1/4' out	10
48081	3/8' out	10
48090	3/8' in	10
48091	1/4' in	10

ADAPTER

No.	specification	
48054	3/8' out x 1/4' in	10
48055	1/2' out x 3/8' in	10
48056	reduction 3/8' out x 1/2' in	10
48057	reduction 1/4' out x 3/8' in	10

DOUBLE ADAPTER

No.	specification	
48050	connection 1/4' out x 1/4' out	10
48051	reduction 1/4' out x 3/8' out	10



ADAPTER WITH THREAD

No.	specification	
48085	1/4' - 6 mm	10
48086	3/8' - 9 mm	10
48087	1/2' - 13 mm	10



ADAPTER

No.	specification	
48060	Ø 6 mm - 1/8' out	10
48061	Ø 6 mm - 1/4' out	10
48062	Ø 6 mm - 3/8' out	10
48063	Ø 9 mm - 1/4' out	10
48064	Ø 9 mm - 3/8' out	10
48065	Ø 13 mm - 1/4' out	10
48066	Ø 13 mm - 3/8' out	10
48067	Ø 6 mm - 3/8' in	10
48068	Ø 9 mm - 3/8' in	10
48093	Ø 6 mm - 1/4' in	10
48094	Ø 9 mm - 1/4' in	10



SAFETY PRODUCTS



SAFETY GOOGLES

CE EN 166

No.	specification	
50510		10

SAFETY GOOGLES

CE EN 166

No.	specification	
50514		10



SAFETY GOOGLES

adjustable length of temples

CE EN 166

No.	specification	
50511		12

SAFETY GOOGLES

CE EN 170

No.	specification	
50512	dark	12

SAFETY GOOGLES

CE EN 166

No.	specification	
50513		1



PROTECTIVE HEADPHONES

CE EN 352 27 dB



No.	specification	
50563		1



PROTECTIVE HEADPHONES

CE EN 352 27 dB



No.	specification	
50564		1



SAFETY FACE SHIELD

CE EN 166

No.	specification	
50556		10



SAFETY HELMET CLIMAX

CE EN 397
MADE IN EU

No.	specification	
50550	blue	30
50551	red	30
50553	white	30
50554	yellow	30



PROTECTIVE SHIELD WITH GRID

CE EN 1731

No.	
50562	10



REFLECTIVE VEST

CE EN 20471

No.	specification	
50570	orange	100
50571	yellow	100



EARPLUGS

No.	specification	
50560		100



EARPLUGS WITH CORD

No.	specification	
50559		100



RESPIRATOR

CE EN 149

No.	specification	
50500	FFP2 without valve	30
50501	FFP1 without valve	30



RESPIRATOR

CE EN 149

No.	specification	
50502	FFP1 with valve	20
50503	FFP2 with valve	20



FACE MASK

50x

MOQ 40



No.	specification	
50505		40



LEATHER GLOVES, REINFORCED

· With lining in palm

CE EN 166

No.	specification	
50518	size 11"	12



LEATHER GLOVES, REINFORCED

· With lining in palm

CE EN 388

No.	specification	
50519	size 10,5"	12



LEATHER GLOVES

CE EN 388

No.	specification	
50520	size 10,5"	12



LEATHER GLOVES

CE EN 388

No.	specification	
50521	size 10,5"	12



WINTER LEATHER GLOVES

CE EN 388

No.	specification	
50523	size 11"	12



COTTON GLOVES WITH DOTS

No.	specification	
50524	size 10"	12



COTTON GLOVE, DIPPED IN PVC

CE EN 388

No.	specification	
50525	size 10" - length 35 cm	12



POLYESTER GLOVES WITH PVC DOTS

· With PVC dots

No.	specification	
50526	size 10"	12



COTTON GLOVE, DIPPED IN LATEX

CE EN 388

No.	specification	
50522	size 10"	12



NYLON GLOVES WITH NITRILE COATING

CE EN 388

No.	specification	
50533	size 10"	12



NYLON GLOVES WITH LATEX FOAM COATING

CE EN 388

No.	specification	
50537	size 10"	12



NYLON GLOVES WITH NITRILE FOAM COATING

· With PVC dots

CE EN 388

No.	specification	
50539	size 10"	12



CRYL WINTER GLOVES WITH LATEX COATING

CE EN 388

No.	specification	
50529	size 10"	12



GLOVES FOR GARDENING

No.	specification	
50557	size 7"	12
50558	size 8"	12
50549	size 9"	12



COTON GLOVES

· With PVC dots

No.	specification	
50531	size 9"	12



GOATSKIN LEATHER GLOVES



No.	specification	
50541	size 9"	12
50542	size 10"	12



GLOVE NYLON - PIGSKIN LEATHER



No.	specification	
50544	size 10"	12



NYLON GLOVE, DIPPED IN POLYURETAN



No.	specification	
50527	size 10"	12



LEATHER GLOVES FOR WELDING



No.	specification	
50540	size 11"	12



DISPOSABLE VINYL GLOVES

* clear, powder free



No.	specification	
50532	size 9"	100



SAFETY OVERALLS WITH HOOD

No.	specification	
50585	size M	1
50586	size L	1
50587	size XL	1
50588	size XXL	1



APRON FOR WELDING



No.	specification	
50555	leather	1



FESTA

KNEE PROTECTOR



KNEELING CREEPER

No.	specification	
37135		1

No.	specification	
37145	gel	8



FESTA

KNEE PROTECTOR



FESTA

KNEE PROTECTOR



FESTA

KNEE PROTECTOR



No.	specification	
37140	gel	12

No.	specification	
37144	gel	12

No.	specification	
37143		12



FESTA

KNEE PROTECTOR

KNEE PROTECTOR



KNEE PROTECTOR

No.	specification	
37142	komfort	20

No.	specification	
37139	neopren	10

No.	specification	
37141		6



FESTA

BAG FOR TOOL WITH METAL HANDEL

No.	height	length	depth	
37331	280 mm	490 mm	230 mm	 2



FESTA

BAG

No.	width	height	depth	
37332	480 mm	290 mm	250 mm	 1



FESTA

BAG

No.	width	height	depth	
37330	610 mm	400 mm	270 mm	 5



FESTA

CASE FOR TOOL

reinforced pockets

No.	specification
37325	



10



FESTA

CASE FOR TOOL

reinforced pockets

No.	specification
37326	



12



FESTA

BELT

No.	specification
37328	145 cm



20





FESTA

MOUNTING BELT

· 14 pockets + eye

No.	length	width	
37311	120 cm	6 cm	1



FESTA

CASE FOR TOOLS

· 8 pockets

No.	width	height	
37320	300 mm	250 mm	1



FESTA

CASE FOR TOOLS

· 4 pockets

No.	width	height	
37321	350 mm	300 mm	1



FESTA

NYLON BELT

No.	length	width	
37310	120 cm	6 cm	1



FESTA

WORKING JACKET

No.	specification	
37350		20

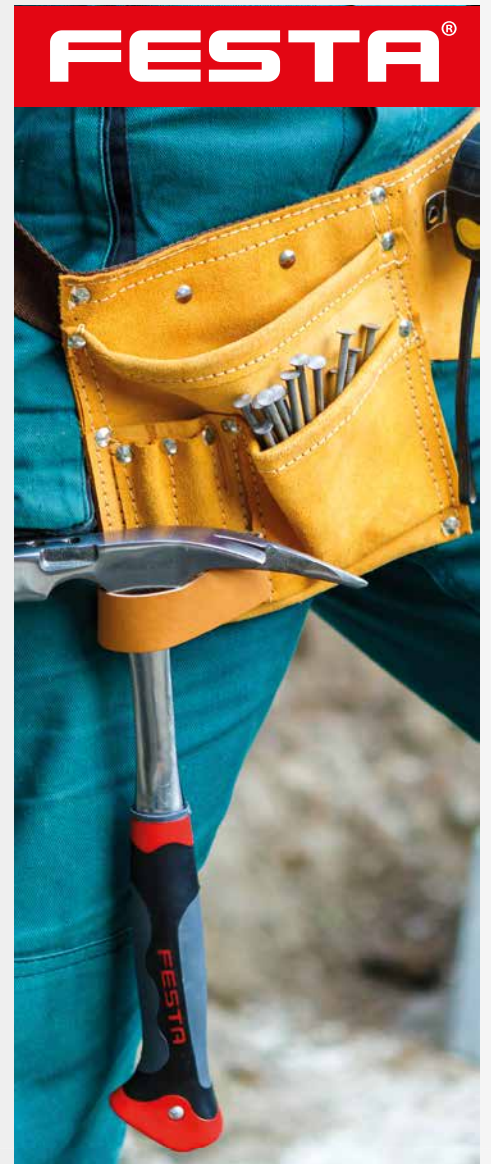

FESTA

TOOL BELT LEATHER



No.	specification	
37302	6 pockets	50
37303	11 pockets	25



TOOL BELT LEATHER



No.	specification	
37300	6 pockets	50
37301	11 pockets	25



LEATHER BAG PROFESIONAL

ELECTRICIAN LEATHER BAG



No.	height	length	depth	
37342	270 mm	430 mm	180 mm	1

No.	height	length	depth	
37341	260 mm	430 mm	200 mm	1



LEATHER BAG WITH REINFORCED BOTTOM



No.	height	length	depth	
37340	240 mm	430 mm	150 mm	1



CRAFTMAN LEATHER BAG WITH STRAP

No.	height	length	depth	
37344	250 mm	300 mm	130 mm	1



BAG WITH REINFORCED BOTTOM

No.	height	length	depth	
37343	240 mm	430 mm	150 mm	1



ELECTRICIAN BAG

No.	height	length	depth	
37345	270 mm	430 mm	180 mm	1



TOOL BELT - LEATHER



No.	specification	
37308		20



TOOL BELT - LEATHER



No.	specification	
37309		20



162

CUTTERS KDS



164

CUTTERS FESTA



170

SCRAPERS



171

SPARE BLADES



173

KNIVES AND MACHETES



178

CUTTERS, PLIERS FOR
PVC PIPES

181

POLYSTYRENE CUTTER



184

DRILLS FOR METAL



194

HOLESAW, CHISELS AND
PUNCHES

198

DIAMOND HOLESAW



204

DRILLS, HOLESAWS,
ROUTER BITS

208

DRILL CHUCK

DRILLS, CUTTING
AND DRILLING TOOLS

160 - 241



210

ROTATING AND GRINDING
BRUSHES



214

GRINDING DISC AND
PAPERS



219

RASP FOR DRYWALL



220

FILES AND RASPS



222

JIG SAW BLADES



225

SAW BLADES



228

SAWS FOR WOOD, METAL
AND ETC



234

DIAMANT DISCS



238

CUTTING AND GRINDING
DISCS



KDS®

Knives of Japanese company KDS

- excellent ergonomics of grips
- high performance and lifespan of blades
- blades of the best materials
- low cutting resistance enabling easy cutting



KDS® CUTTER



No.	specification	
16002	LC405 18 mm green	25
16011	LB10 spare blade	10



KDS® CUTTER



No.	specification	
16003	G11 18 mm + 2 spare blade	10
16012	GB10 spare blade	10



KDS® CUTTER



No.	specification	
16019	LI9 18 mm + 2 spare blade	10
16011	LB10 spare blade	10
16012	GB10 spare blade	10



KDS®
CUTTER



No.	specification	
16004	H11 25 mm	10
16013	HB10 spare blade	10



KDS®
CUTTER



No.	specification	
16005	S14 9 mm + 2 spare blade	10
16010	SB10 spare blade	10



KDS®
SCALPEL



No.	specification	
16006	D12 + 16 spare blade	10



KDS®
SPARE BLADES

10x

No.	specification	
16010	SB10 9 0,38 mm 13 segments	20
16011	LB10 18 0,5 mm 15 segments	20
16012	GB10 18 0,6 mm 15 segments	20
16013	HB10 25 0,7 mm 7 segments	10



KDS®
SPARE BLADES

- special alloy
- double grinding
- enhanced lifetime
- low cutting resistance
- enabling easy cutting

10x

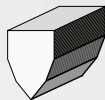

No.	specification	
16016	LB10B 18 0,5 mm 8 segments	20
16017	HB10B 25 0,7 mm 7 segments	10



• illustration picture

KDS®
STAND FOR BLADES

- items in stand 16998 - 16001 · 5 pcs
- 16003 · 5 pcs
- 16004 · 3 pcs
- 16005 · 3 pcs
- 16006 · 2 pcs
- 16008 · 3 pcs
- 16010 · 4 pcs
- 16012 · 4 pcs
- 16013 · 1 pcs
- 16016 · 4 pcs
- 16018 · 4 pcs
- 16019 · 4 pcs
- 16020 · 4 pcs

No.	specification	
16999	stand	1
16998	filled stand with items	1



FESTA
CUTTER, CERAMIC BLADE

- 3x sharper than the steel blade
- 10x longer lifetime
- Refractory, non-conductive, non-magnetic



No.	specification	
16131	18 mm	10
16066	spare blade 18 mm, 5 pcs	10



FESTA
CUTTER



No.	specification	
16110	L11 18 mm + 1 spare blade	12

FESTA
CUTTER



No.	specification	
16100	L12 18 mm + 1 spare blade	12



FESTA
CUTTER



No.	specification	
16105	L17 18 mm + 1 spare blade	12

FESTA
CUTTER



No.	specification	
16125	L4 9 mm	24
16120	L8 18 mm	24



FESTA
CUTTER



No.	specification	
16115	L10 9 mm	24

FESTA
CUTTER



No.	specification	
16150	18 mm	MOQ 24
16151	18 mm without logo FESTA	20



FESTA

CUTTER

ALU



No.	specification	
16136	18 mm	12



FESTA

CUTTER

ALU



No.	specification	
16137	25 mm	12



FESTA

CUTTER

• Anti-Slip rubber coating

+4 ALU



No.	specification	
16090	18 mm	12



FESTA

CUTTER

• Anti-Slip rubber coating

+4 ALU



No.	specification	
16091	25 mm	6



FESTA

CUTTER

• Anti-Slip rubber coating

ALU



No.	specification	
16145	L25 18 mm	12



FESTA

CUTTER

• Anti-Slip rubber coating

ALU



No.	specification	
16144	L24 18 mm	12



CUTTER

ALU



No.	specification	
16143	18 mm	12



CUTTER

ALU



No.	specification	
16142	18 mm	12 1



CUTTER

ALU

No.	specification
16025	18 mm



12



FESTA

CUTTER

ALU

No.	specification
16029	18 mm



25



FESTA

CUTTER

· Anti-Slip rubber coating

No.	specification
16146	18 mm



12



FESTA

CUTTER

· Anti-Slip rubber coating

No.	specification
16147	25 mm



12



FESTA

CUTTER

· Anti-Slip rubber coating



No.	specification
16130	L18 18 mm + 5 spare blade



12



FESTA

CUTTER

· Anti-Slip rubber coating



No.	specification
16135	L20 25 mm + 5 spare blade



6



FESTA

CUTTER

· Anti-Slip rubber coating

No.	specification
16140	L22 18 mm



12



FESTA

CUTTER

· Anti-Slip rubber coating

ALU

No.	specification
16034	25 mm



12



FESTA

CUTTER

INOX

No.	specification
16085	9 mm



24



FESTA

CUTTER

INOX

No.	specification
16086	18 mm



24



SAFETY KNIFE

· self-retracting blade

No.	specification
16057	135 mm



12



FESTA

SAFETY KNIFE

ALU

INOX

No.	specification
16058	
16074	spare blade 10 pcs



6

1



FESTA

CUTTER

+5

ALU

No.	specification
16037	+ 5 spare blade



6



FESTA

FOLDING KNIFE

+5

ALU

No.	specification
16023	Nůž zavírací + 5 spare blade
16071	spare blade 10 pcs



12

10



FESTA

FOLDING KNIFE - SET

ALU

No.	specification
16095	25 blade



1



FESTA

CUTTER

· Anti-Slip rubber coating



No.	specification	
16035	+ 2 spare blade	12



FESTA

DOLPHINE CUTTER



No.	specification	
16033	NP 110 + 3 spare blade	5



FESTA

CUTTER



No.	specification	
16038	+ 5 spare blade	12



DOLPHINE CUTTER



No.	specification	
16032	NP 109	48



ADJUSTABLE CUTTER



No.	specification	
16031	NS 107 B	24



CUTTER



No.	specification	
16030	NS 107	24



CUTTER FOR CARPETS

· for carpet and flooring



No.	specification	
16036	45 mm	12



CUTTER HOOKED FOR FLOORS

· for carpet and flooring



No.	specification	
16041		12



CUTTER

ALU



No.	specification	
16046	18 mm	12



CUTTER

No.	specification	
16028	S 201 18 mm	24



CUTTER

No.	specification	
16026	P 205 18 mm	30



CUTTER

HOBBY

No.	specification	
16021	P 201 9 mm	60



CUTTER

HOBBY

No.	specification	
16024	P 204 18 mm	60



MOQ 24



CUTTER

Anti-Slip rubber coating

No.	specification	
16141	18 mm	24



CUTTER SET

HOBBY 12x

No.	specification	
16053	9 mm	12
16055	18 mm	12



CUTTER SET

HOBBY 3x

No.	specification	
16043		24





WINDOW SCRAPER

ALU



No.	specification	
16059	50 mm	10
16082	spare blade	1



WINDOW SCRAPER

for use with 18 mm blades for cutters

ALU



No.	specification	
16054	100 mm	1



FESTA

SCRAPER WITH RUBBER HANDLE

• Anti-Slip rubber coating



No.	specification	
16049		12
16069	spare blade	1



FESTA

WINDOW SCRAPER



No.	specification	
16052	48 cm length	6
16070	spare blade	25



WINDOW SCRAPER



No.	specification	
16051		24



WINDOW SCRAPER



No.	specification	
16050		24



SET OF SCRAPERS FOR APPLICATION AND REMOVING SILIKON

3x



No.	specification	
16042		12



FESTA

SPARE BLADES

- segments
- 3x longer life
- double grinding
- low cutting resistance

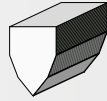

SK2 10x



No.	specification	
16064	25 0,7 mm	20



SPARE BLADES

- segments

10x



No.	specification	
16068	25 0,6 mm	20



FESTA

SPARE BLADES

- segments
- 3x longer life
- double grinding
- low cutting resistance

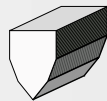

SK2 10x



No.	specification	
16062	18 0,7 mm	10



FESTA

SPARE BLADES

- segments
- 3x longer life
- double grinding
- low cutting resistance

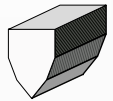

SK2 10x



No.	specification	
16063	18 0,7 mm	10



FESTA

SPARE CERAMIC BLADE

- segments
- 3x sharper than the steel blade
- 10x longer lifetime
- Refractory, non-conductive, non-magnetic

5x



No.	specification	
16066	18 0,6 mm	10



SPARE BLADES

- segments

10x



No.	specification	
16067	18 0,5 mm	10



SPARE BLADES

- segments

10x



No.	specification	
16065	18 0,5 mm	60



SPARE BLADES

- segments

10x



No.	specification	
16081	18 0,5 mm	60



SPARE BLADES

- segments



10x



No.	specification	
16078	18 0,5 mm	25



SPARE BLADES

- segments



10x



No.	specification	
16077	18 0,6 mm	25





SPARE BLADES 30°

· 7 segments

10x

No.	specification	
16061	9 0,4 mm	60



SPARE BLADES

· 13 segments

10x

No.	specification	
16060	9 0,45 mm	10

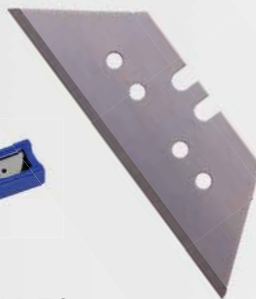

FESTA

SPARE BLADES

· for 16058

10x

No.	specification	
16074		1

FESTA

SPARE BLADES

10x



No.	specification	
16072	R 004	10

FESTA

SPARE BLADES

10x



No.	specification	
16075	R 003	10



SPARE BLADES

10x

No.	specification	
16071	R 001	60

SPARE BLADES

10x

No.	specification	
16073	R 002	60

SPARE BLADES

5x

No.	specification	
16084	18 mm	50

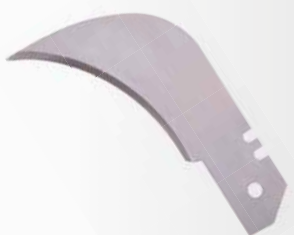

SPARE BLADES

5x

No.	specification	
16083	18 mm	50

SPARE BLADES

· for 34315

No.	specification	
34316		1

SPARE BLADES FOR SCRAPER

· for 16052

No.	specification	
16070	100 mm	25



FESTA

KNIFE

- nylon handle
- teflon coated blade
- case with fuse and clip



No.	specification	
16234	21 10 cm	10



FESTA

HUNTING KNIFE



No.	specification	
16229	23 10 cm	12



FESTA

MULTIFUNCTION CHISEL

- thickened blade



No.	specification	
16231	20 8 cm	12



TECHNICAL KNIFE

- thickened blade



No.	specification	
16230	21 10 cm	12



KNIFE



No.	specification	
16022	16 6,5 cm	100



FESTA

KNIFE FOR CARPETS AND FLOORING

No.	specification	
16225	20 8,5 cm	12



FESTA

ELECTRICIAN KNIFE

- thickened blade



No.	specification	
16212	15 3,2 cm	12



FESTA

STRIPPER CUTTER

No.	specification	
16201	Ø 8 - 27 mm	10



FESTA
ELECTRICIAN KNIFE

INOX		
No.	specification	
16211	20 8,5 cm	10

FESTA
ELECTRICIAN KNIFE

INOX		
No.	specification	
16210	20,5 9 cm	10



FESTA
INOCULATION KNIFE

INOX		
No.	specification	
16219	19 11 cm	24

FESTA
PLANT KNIFE

INOX		
No.	specification	
16218	18,5 10,5 cm	24



FESTA
LOCK KNIFE

INOX		
No.	specification	
16220	18,5 11 cm	24

FESTA
POCKET KNIFE

INOX		
No.	specification	
16235	17,5 8,5 cm	24



FESTA
POCKET KNIFE

INOX		
No.	specification	
16221	21 12 cm	24

FESTA
POCKET KNIFE

INOX		
No.	specification	
16236	22,5 10 cm	24



FESTA

POCKET KNIFE

No.	specification
16209	14,5 5,5 cm



1



FESTA

POCKET KNIFE

INOX

No.	specification
16222	20 12 cm



24



FESTA

POCKET KNIFE

INOX ALU

No.	specification
16223	18,5 10,5 cm



24



FESTA

POCKET KNIFE MULTIFUNCTION

· 10 functions

INOX

No.	specification
16226	17,5 7 cm



24



FESTA

POCKET KNIFE MULTIFUNCTION

· 5 functions

INOX

No.	specification
16228	27 10,5 cm



24



HUNTING LOCK KNIFE

· 3 functions

No.	specification
16227	20,5 10 cm



24



POCKET KNIFE MULTIFUNCTION

· 7 functions

INOX

No.	specification
16224	17,5 7 cm



24



FESTA

MULTIFUNCTION PLIERS

- 9 functions
- bag



No.	specification
16232	



12



FESTA

KNIFE FOR MINERAL WOOL

No.	specification
16198	44,5 33 cm



12



FESTA

KNIFE FOR ISOLATION

- for mineral wool, polystyrene

No.	specification
16199	48 35 cm



10



FESTA

MACHETE



No.	specification
45069	440 mm

6



FESTA

MACHETE



No.	specification
44950	490 mm

4



MACHETE STAINLESS STEEL



No.	specification
45083	430 mm
45084	600 mm

12
6



MACHETE

- handle made out of ash wood

No.	specification
45081	510 mm
45082	710 mm

36
36



SCALPELS - SET

23x



24

No. specification

16282



SCALPELS - SET

13x



10

No. specification

16281



WHETSTONE ROUNDED

No. specification

250 x 33 x 18 mm



20

45370

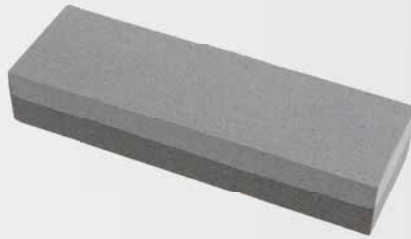

WHETSTONE

No. specification

150 x 50 x 30 mm



1

45045



WHETSTONE

No. specification

205 x 15 mm



100

45046



SHARPENER FOR KNIVES AND SCISSORS

No. specification

16991



20

specification



SHARPENER FOR KNIVES AND SCISSORS

No. specification

16990



1

specification

Ø 50 mm



SHARPENER FOR KNIVES AND SCISSORS

No. specification

45048



20

specification



SHARPENER FOR KNIVES AND SCISSORS 6 IN

No. specification

45068



10

specification





FESTA

PIPE WELDER

- voltage / frequency 230 V / 50 Hz
- power consumption 750 / 1500 W
- temperature 0-300 C°
- extensions Ø 20,25,32,40,50,63 mm
- weight 1,6 kg



• package included: measuring tape, spirit level, screwdriver, hex key, 6x welding adapter, stand, shelf case

No. 17182



FESTA

PIPE WELDER

- voltage / frequency 230 V / 50 Hz
- power consumption 800 / 1000 W
- temperature 0-300 C°
- extensions Ø 16, 20, 25, 32 mm
- weight 1 kg



• package included: hex key, 4x welding adapter, stand, shelf case

No. 17183





FESTA®



FESTA®
PLIERS FOR PVC PIPE

Ø max.
42 mm



No.	specification	
17027		10
16315	spare blade	1



FESTA®
SPARE BLADE FOR PLIERS

· for pliers 17027

No.	specification	
16315		1

NEW



FESTA®
PLIERS FOR PVC PIPE

Ø max.
32 mm



No.	specification	
17037		12



FESTA®
PLIERS FOR PVC PIPE

Ø max.
42 mm



No.	specification	
17026		6



FESTA®
PLIERS FOR THE PROFILE

· plinths, profiles, tubes

Ø 17 mm Ø 20 mm Ø 27 mm

5x



No.	specification	
17050		8



FESTA

PIPE CUTTER

Ø 3-32 mm



No.	specification	Icon	Quantity
16301			10
16311	spare blade		1



FESTA

PIPE CUTTER

Ø 6-64 mm



No.	specification	Icon	Quantity
16304			6
16312	spare blade		1



PIPE CUTTER

Ø 3-32 mm



No.	specification	Icon	Quantity
16303			10
16311	spare blade		1



PIPE CUTTER

Ø 3-32 mm



No.	specification	Icon	Quantity
16300			10
16310	spare blade		1

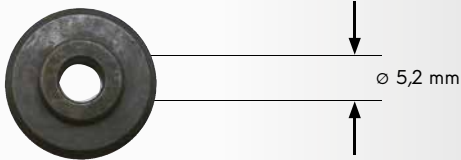

NEW



SPARE CIRCLE FOR PVC PIPE CUTTER



No.	specification	Icon	Quantity
16310	Ø 17,5 mm x 6 m for 16300		1
16311	Ø 18,0 mm x 4,5 mm for 16303, 16301		1
16312	Ø 27,5 mm x 6 mm for 16304		1

DEBURRER

1/4"

No.	specification	Icon	Quantity
16321			1

PLASTIC EDGE CLEANER

Ø 6-32 mm

No.	specification	Icon	Quantity
16320			1



CLEAN CUTTER (MILLING) SET

1/4" HSS

4x

No.	specification	Icon	Quantity
20360			10



DEBURRER

No.	specification	Icon	Quantity
20361			1



FESTA

CORDLESS POLYSTYRENE CUTTER

- battery 36 V, 1,5Ah Li-ion
- power 180 W
- temperature max 350 C°
- length of knife 20 cm



• equipment: 2 pcs battery, charger, blade, cleaning brass brush, inbus

No.	specification
35323	



FESTA

ELECTRIC POLYSTYRENE CUTTER

- voltage / frequency 230 V/50 Hz
- power consumption 250 W
- temperature 50-600 C°
- length of knife 25 cm
- length of supply cable 3 m



• equipment: cleaning brass brush, inbus, blades 25 and 30 cm, case

No.	specification	
35326	electric polystyrene cutter	1
35328	Spare knife for polystyrene cutter 14 cm	1
35329	Spare knife for polystyrene cutter 25 cm	1



GUIDE BAR FOR POLYSTYRENE CUTTER

• for 35323, 35326

No.	specification	
35327	Guide bar	1
35335	Spare knife - 30 cm	1



FESTA

POLYSTYRENE ELECTRIC CUTTER



• temperature regulation

No.	specification
35325	220 W



NEW

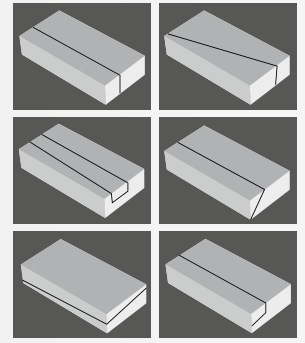

137 cm

FESTA

POLYSTYRENE CUTTER

- voltage | frequency: 230 V/50 Hz
- power consumption: 160 W
- length of cut: 137 cm
- height of cut: 30 cm
- protection: IP44
- angle of cut: 0° - 90°
- equipment: stand, foot switch, scaffold holder, 2x Ni-Cr cutting wire, cleaning brass brush, tools and fasteners, plastic box with wheels



No. Specification
35348



1

NEW



1,7 m

FESTA

FOOT SWITCH FOR POLYSTYRENE CUTTER

for 35330, 35345, 35348

No. Specification
35334



1

NEW



FESTA

STAND FOR POLYSTYRENE CUTTER

for 35330, 35345, 35348

No. Specification
35336



1

NEW



FESTA

REPLACEMENT SPRING FOR A POLYSTYRENE CUTTER

for 35330, 35345, 35348

No. Specification
35332



1

NEW



FESTA

SCAFFOLD HOLDER FOR POLYSTYRENE CUTTER

for 35330, 35345, 35348

No. Specification
35333



1

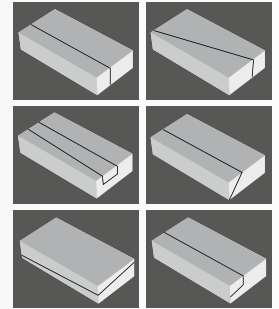
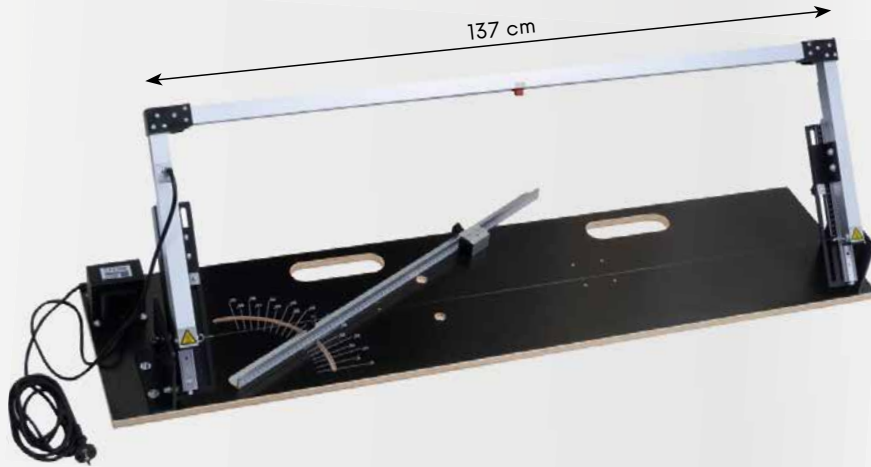

FESTA

POLYSTYRENE CUTTER

- voltage | frequency: 230 V / 50 Hz
- power consumption: 160 W
- length of cut: 137 cm
- height of cut: 30 cm
- protection: IP44
- angle of cut: 0° - 90°



• equipment: Ni-Cr cutting wire, cleaning brass brush, inbus



No.	specification	
35345	Polystyrene cutter 1500 x 450 mm	1
35346	Spare heating string Ni-Cr	1
35347	Spare power supply	1

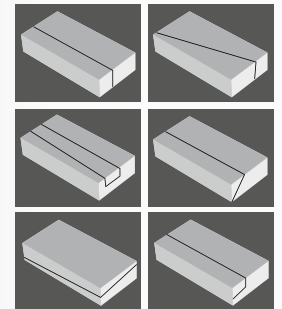
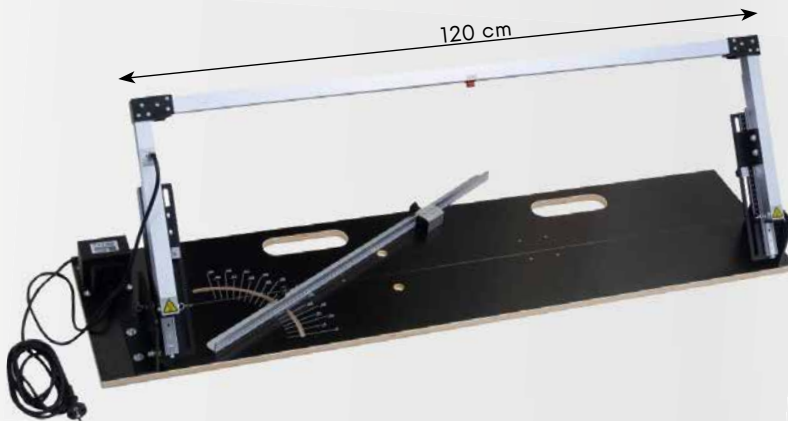

FESTA

POLYSTYRENE CUTTER

- voltage | frequency: 230 V / 50 Hz
- power consumption: 160 W
- length of cut: 120 cm
- height of cut: 30 cm
- protection: IP44
- angle of cut: 0° - 90°



• equipment: Ni-Cr cutting wire, cleaning brass brush, inbus



No.	specification	
35330	Polystyrene cutter 1350 x 450 mm	1
35331	Spare heating string Ni-Cr	1
35347	Spare power supply	1

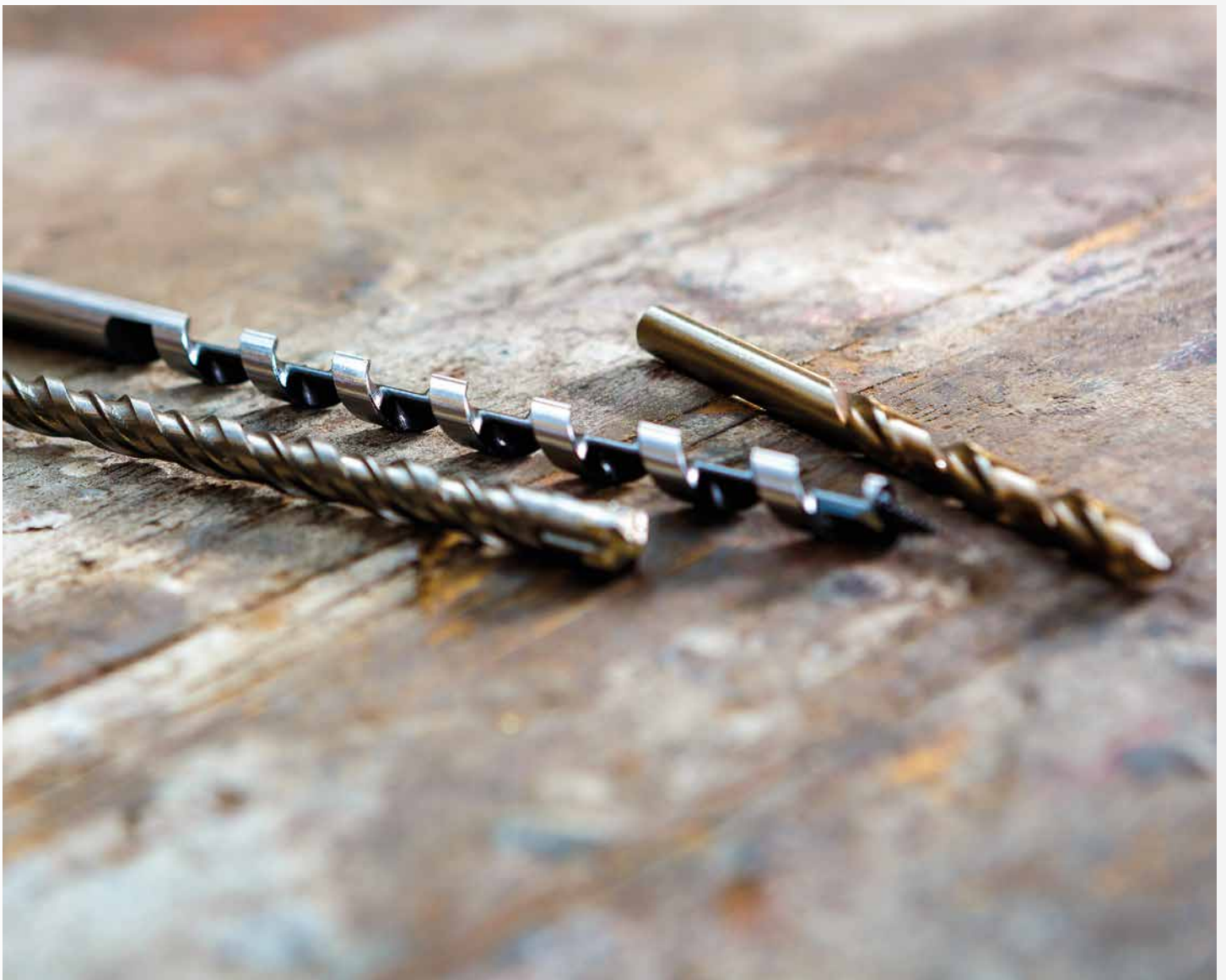

FESTA

FULLY GROUND DRILL HSS-G

Co 5%, W 6%
Mo 5%, Cr 4%, V 4%

HSS

DIN 338

135°

INOX

1400 MPa



No.	specification		No.	specification		No.	specification	
22510	Ø 1,00 mm	1	22548	Ø 4,80 mm	1	22590	Ø 9,00 mm	1
22515	Ø 1,50 mm	1	22550	Ø 5,00 mm	1	22595	Ø 9,50 mm	1
22520	Ø 2,00 mm	1	22555	Ø 5,50 mm	1	22600	Ø 10,00 mm	1
22525	Ø 2,50 mm	1	22560	Ø 6,00 mm	1	22602	Ø 10,20 mm	1
22530	Ø 3,00 mm	1	22565	Ø 6,50 mm	1	22605	Ø 10,50 mm	1
22532	Ø 3,20 mm	1	22568	Ø 6,80 mm	1	22610	Ø 11,00 mm	1
22535	Ø 3,50 mm	1	22570	Ø 7,00 mm	1	22615	Ø 11,50 mm	1
22540	Ø 4,00 mm	1	22575	Ø 7,50 mm	1	22620	Ø 12,00 mm	1
22542	Ø 4,20 mm	1	22580	Ø 8,00 mm	1	22625	Ø 12,50 mm	1
22545	Ø 4,50 mm	1	22585	Ø 8,50 mm	1	22630	Ø 13,00 mm	1



FESTA

FULLY GROUND DRILL HSS-G W9%

W 9%, Mo 3%
Cr 4%, V 1% **HSS** **DIN 338**

INOX **1100 MPa**

MOQ

No.	specification	
19530	Ø 1,00 mm	10
19532	Ø 1,20 mm	10
19533	Ø 1,30 mm	10
19534	Ø 1,40 mm	10
19535	Ø 1,50 mm	10
19536	Ø 1,60 mm	10
19537	Ø 1,70 mm	10
19538	Ø 1,80 mm	10
19539	Ø 1,90 mm	10
19540	Ø 2,00 mm	10
19541	Ø 2,10 mm	10
19542	Ø 2,20 mm	10
19543	Ø 2,30 mm	10
19544	Ø 2,40 mm	10
19545	Ø 2,50 mm	10
19546	Ø 2,60 mm	10
19547	Ø 2,70 mm	10
19548	Ø 2,80 mm	10
19550	Ø 3,00 mm	10
19552	Ø 3,20 mm	10
19553	Ø 3,30 mm	10
19554	Ø 3,40 mm	10
19555	Ø 3,50 mm	10
19556	Ø 3,60 mm	10

No.	specification	
19557	Ø 3,70 mm	10
19558	Ø 3,80 mm	10
19559	Ø 3,90 mm	10
19560	Ø 4,00 mm	10
19561	Ø 4,10 mm	10
19562	Ø 4,20 mm	10
19563	Ø 4,30 mm	10
19564	Ø 4,40 mm	10
19565	Ø 4,50 mm	10
19566	Ø 4,60 mm	10
19567	Ø 4,70 mm	10
19568	Ø 4,80 mm	10
19569	Ø 4,90 mm	5
19570	Ø 5,00 mm	5
19573	Ø 5,30 mm	5
19574	Ø 5,40 mm	5
19575	Ø 5,50 mm	5
19576	Ø 5,60 mm	5
19577	Ø 5,70 mm	5
19578	Ø 5,80 mm	5
19579	Ø 5,90 mm	5
19580	Ø 6,00 mm	5
19581	Ø 6,10 mm	5
19583	Ø 6,30 mm	5
19584	Ø 6,40 mm	5

No.	specification	
19585	Ø 6,50 mm	5
19586	Ø 6,60 mm	5
19587	Ø 6,70 mm	5
19588	Ø 6,80 mm	5
19589	Ø 6,90 mm	5
19590	Ø 7,00 mm	5
19591	Ø 7,10 mm	5
19593	Ø 7,30 mm	5
19594	Ø 7,40 mm	5
19595	Ø 7,50 mm	5
19596	Ø 7,60 mm	5
19597	Ø 7,70 mm	5
19598	Ø 7,80 mm	5
19599	Ø 7,90 mm	5
19600	Ø 8,00 mm	5
19601	Ø 8,10 mm	5
19603	Ø 8,30 mm	5
19604	Ø 8,40 mm	5
19605	Ø 8,50 mm	5
19606	Ø 8,60 mm	5
19607	Ø 8,70 mm	5
19608	Ø 8,80 mm	5
19609	Ø 8,90 mm	5
19610	Ø 9,00 mm	5
19611	Ø 9,10 mm	5
19612	Ø 9,20 mm	5
19613	Ø 9,30 mm	5
19614	Ø 9,40 mm	5
19615	Ø 9,50 mm	3
19616	Ø 9,60 mm	3
19617	Ø 9,70 mm	3
19618	Ø 9,80 mm	3
19619	Ø 9,90 mm	3
19620	Ø 10,00 mm	3
19621	Ø 10,10 mm	3
19622	Ø 10,20 mm	3
19623	Ø 10,30 mm	3
19624	Ø 10,40 mm	3
19625	Ø 10,50 mm	3
19626	Ø 10,60 mm	3

No.	specification	
19627	Ø 10,70 mm	3
19628	Ø 10,80 mm	3
19629	Ø 10,90 mm	3
19630	Ø 11,00 mm	3
19631	Ø 11,10 mm	3
19632	Ø 11,20 mm	3
19633	Ø 11,30 mm	3
19634	Ø 11,40 mm	3
19635	Ø 11,50 mm	3
19636	Ø 11,60 mm	3
19637	Ø 11,70 mm	3
19638	Ø 11,80 mm	3
19639	Ø 11,90 mm	3
19640	Ø 12,00 mm	3
19641	Ø 12,10 mm	3
19642	Ø 12,20 mm	3
19643	Ø 12,30 mm	3
19644	Ø 12,40 mm	3
19645	Ø 12,50 mm	3
19646	Ø 12,60 mm	1
19647	Ø 12,70 mm	1
19648	Ø 12,80 mm	1
19649	Ø 12,90 mm	1
19650	Ø 13,00 mm	1
19651	Ø 13,20 mm R13	1
19652	Ø 13,50 mm R13	1
19653	Ø 14,00 mm R13	1
19654	Ø 14,50 mm R13	1
19655	Ø 15,00 mm R13	1
19656	Ø 15,50 mm R13	1
19657	Ø 16,00 mm R13	1
19658	Ø 16,50 mm R13	1
19659	Ø 17,00 mm R13	1
19660	Ø 17,50 mm R13	1
19661	Ø 18,00 mm R13	1
19662	Ø 18,50 mm R13	1
19663	Ø 19,00 mm R13	1
19664	Ø 19,50 mm R13	1
19665	Ø 20,00 mm R13	1



FESTA

BOX WITH FULLY GROUND DRILLS HSS-G W 9%

W 9%, Mo 3%
Cr 4%, V 1% **HSS** **DIN 338**

INOX **1100 MPa**

No.	specification	
19669		1
90191	without drills	1

No.	set content	No.	set content
19530	Ø 1,00 mm 20x	19585	Ø 6,50 mm 15x
19535	Ø 1,50 mm 20x	19590	Ø 7,00 mm 15x
19540	Ø 2,00 mm 20x	19595	Ø 7,50 mm 15x
19545	Ø 2,50 mm 20x	19600	Ø 8,00 mm 15x
19550	Ø 3,00 mm 20x	19605	Ø 8,50 mm 15x
19552	Ø 3,20 mm 20x	19610	Ø 9,00 mm 15x
19555	Ø 3,50 mm 20x	19615	Ø 9,50 mm 15x
19558	Ø 3,80 mm 20x	19620	Ø 10,00 mm 15x
19560	Ø 4,00 mm 30x	19625	Ø 10,50 mm 6x
19562	Ø 4,20 mm 20x	19630	Ø 11,00 mm 6x
19565	Ø 4,50 mm 20x	19635	Ø 11,50 mm 6x
19568	Ø 4,80 mm 20x	19640	Ø 12,00 mm 6x
19570	Ø 5,00 mm 15x	19645	Ø 12,50 mm 6x
19575	Ø 5,50 mm 15x	19650	Ø 13,00 mm 6x
19580	Ø 6,00 mm 30x		



FESTA

FULLY GROUND DRILL

W 4%, Mo 3%
Cr 4%, V 1%

HSS

DIN 338

ALU 900 MPa

MOQ

No.	specification	
19670	Ø 0,6 mm	10
19671	Ø 0,8 mm	10
19672	Ø 0,9 mm	10
19673	Ø 1,0 mm	10
19674	Ø 1,1 mm	10
19675	Ø 1,2 mm	10
19676	Ø 1,3 mm	10
19677	Ø 1,4 mm	10
19678	Ø 1,5 mm	10
19679	Ø 1,6 mm	10
19680	Ø 1,7 mm	10
19681	Ø 1,8 mm	10
19682	Ø 1,9 mm	10
19683	Ø 2,0 mm	10
19684	Ø 2,1 mm	10
19685	Ø 2,2 mm	10
19686	Ø 2,3 mm	10
19687	Ø 2,4 mm	10
19688	Ø 2,5 mm	10
19689	Ø 2,6 mm	10
19690	Ø 2,7 mm	10
19691	Ø 2,8 mm	10
19692	Ø 2,9 mm	10
19693	Ø 3,0 mm	10

No.	specification	
19694	Ø 3,1 mm	10
19695	Ø 3,2 mm	10
19696	Ø 3,3 mm	10
19697	Ø 3,4 mm	10
19698	Ø 3,5 mm	10
19699	Ø 3,6 mm	10
19700	Ø 3,7 mm	10
19701	Ø 3,8 mm	10
19702	Ø 3,9 mm	10
19703	Ø 4,0 mm	10
19704	Ø 4,1 mm	10
19705	Ø 4,2 mm	10
19706	Ø 4,3 mm	10
19707	Ø 4,4 mm	10
19708	Ø 4,5 mm	10
19709	Ø 4,6 mm	10
19710	Ø 4,7 mm	10
19711	Ø 4,8 mm	10
19712	Ø 4,9 mm	10
19713	Ø 5,0 mm	10
19714	Ø 5,1 mm	10
19715	Ø 5,2 mm	10
19716	Ø 5,3 mm	10
19717	Ø 5,4 mm	10

No.	specification	
19718	Ø 5,5 mm	10
19719	Ø 5,6 mm	10
19720	Ø 5,7 mm	10
19721	Ø 5,8 mm	10
19722	Ø 5,9 mm	10
19723	Ø 6,0 mm	10
19724	Ø 6,1 mm	10
19725	Ø 6,2 mm	10
19726	Ø 6,3 mm	10
19727	Ø 6,4 mm	10
19728	Ø 6,5 mm	10
19729	Ø 6,6 mm	10
19730	Ø 6,7 mm	10
19731	Ø 6,8 mm	10
19732	Ø 6,9 mm	10
19733	Ø 7,0 mm	10
19734	Ø 7,1 mm	10
19735	Ø 7,2 mm	10
19736	Ø 7,3 mm	10
19737	Ø 7,4 mm	10
19738	Ø 7,5 mm	10
19739	Ø 7,6 mm	10
19740	Ø 7,7 mm	10
19741	Ø 7,8 mm	10
19742	Ø 7,9 mm	10
19743	Ø 8,0 mm	10
19744	Ø 8,1 mm	10
19745	Ø 8,2 mm	10
19746	Ø 8,3 mm	10
19747	Ø 8,4 mm	10
19748	Ø 8,5 mm	10
19749	Ø 8,6 mm	5
19750	Ø 8,7 mm	5
19751	Ø 8,8 mm	5
19752	Ø 8,9 mm	5
19753	Ø 9,0 mm	5
19754	Ø 9,1 mm	5
19755	Ø 9,2 mm	5
19756	Ø 9,3 mm	5
19757	Ø 9,4 mm	5
19758	Ø 9,5 mm	5
19759	Ø 9,6 mm	5

No.	specification	
19760	Ø 9,7 mm	5
19761	Ø 9,8 mm	5
19762	Ø 9,9 mm	5
19763	Ø 10,0 mm	5
19764	Ø 10,1 mm	5
19765	Ø 10,2 mm	5
19766	Ø 10,3 mm	5
19767	Ø 10,4 mm	5
19768	Ø 10,5 mm	5
19769	Ø 10,6 mm	5
19770	Ø 10,7 mm	5
19771	Ø 10,8 mm	5
19772	Ø 11,0 mm	5
19773	Ø 11,2 mm	5
19774	Ø 11,3 mm	5
19775	Ø 11,4 mm	5
19776	Ø 11,5 mm	5
19777	Ø 11,6 mm	5
19778	Ø 11,7 mm	5
19779	Ø 11,8 mm	5
19780	Ø 11,9 mm	5
19781	Ø 12,0 mm	5
19782	Ø 12,2 mm	5
19783	Ø 12,5 mm	5
19784	Ø 12,8 mm	5
19785	Ø 12,9 mm	5
19786	Ø 13,0 mm	5
19787	Ø 13,2 mm R13	5
19788	Ø 13,5 mm R13	5
19789	Ø 14,0 mm R13	5
19790	Ø 14,5 mm R13	5
19791	Ø 15,0 mm R13	5
19792	Ø 15,5 mm R13	5
19793	Ø 16,0 mm R13	5
19794	Ø 16,5 mm R13	5
19795	Ø 17,0 mm R13	5
19796	Ø 17,5 mm R13	5
19797	Ø 18,0 mm R13	5
19798	Ø 18,5 mm R13	5
19799	Ø 19,0 mm R13	5
19800	Ø 19,5 mm R13	5
19801	Ø 20,0 mm R13	5



FESTA

BOX WITH FULLY GROUND DRILLS HSS 4341

W 4%, Mo 3%
Cr 4%, V 1%

HSS

DIN 338

ALU 900 MPa

No.	specification	
19802		1
90192	without drills	1

No.	set content	
19673	Ø 1,00 mm	20x
19678	Ø 1,50 mm	20x
19683	Ø 2,00 mm	20x
19688	Ø 2,50 mm	20x
19693	Ø 3,00 mm	30x
19695	Ø 3,20 mm	30x
19698	Ø 3,50 mm	30x
19701	Ø 3,80 mm	30x
19703	Ø 4,00 mm	30x
19705	Ø 4,20 mm	30x
19708	Ø 4,50 mm	30x
19711	Ø 4,80 mm	30x
19713	Ø 5,00 mm	20x
19718	Ø 5,50 mm	20x
19723	Ø 6,00 mm	20x
19728	Ø 6,50 mm	20x
19733	Ø 7,00 mm	10x
19738	Ø 7,50 mm	10x
19743	Ø 8,00 mm	10x
19748	Ø 8,50 mm	10x
19753	Ø 9,00 mm	10x
19758	Ø 9,50 mm	10x
19763	Ø 10,00 mm	10x
19768	Ø 10,50 mm	10x
19772	Ø 11,00 mm	10x
19776	Ø 11,50 mm	10x
19781	Ø 12,00 mm	10x
19783	Ø 12,50 mm	10x
19786	Ø 13,00 mm	5x

FESTA

DRILL HSS EXTENDED

W 4%, Mo 3%
Cr 4%, V 1% **HSS** **DIN 338**



No.	specification		No.	specification	
20220	Ø 2,0 mm x 85 mm	10	20255	Ø 5,5 mm x 139 mm	10
20225	Ø 2,5 mm x 95 mm	10	20260	Ø 6,0 mm x 139 mm	10
20230	Ø 3,0 mm x 100 mm	10	20270	Ø 7,0 mm x 156 mm	10
20235	Ø 3,5 mm x 110 mm	10	20280	Ø 8,0 mm x 165 mm	10
20240	Ø 4,0 mm x 119 mm	10	20290	Ø 9,0 mm x 175 mm	10
20245	Ø 4,5 mm x 126 mm	10	20296	Ø 10,0 mm x 184 mm	10
20250	Ø 5,0 mm x 132 mm	10			

TITANIUM DRILL HSS TIN

· titanium surface to enhance performance and durability

TiN **HSS** **DIN 338**



No.	specification		No.	specification		No.	specification	
20400	Ø 1,0 mm	1	20411	Ø 4,8 mm	1	20422	Ø 9,5 mm	1
20401	Ø 1,5 mm	1	20412	Ø 5,0 mm	1	20423	Ø 10,0 mm	1
20402	Ø 2,0 mm	1	20413	Ø 5,5 mm	1	20424	Ø 10,2 mm	1
20403	Ø 2,5 mm	1	20414	Ø 6,0 mm	1	20425	Ø 10,5 mm	1
20404	Ø 3,0 mm	1	20415	Ø 6,5 mm	1	20426	Ø 11,0 mm	1
20405	Ø 3,2 mm	1	20416	Ø 6,8 mm	1	20427	Ø 11,5 mm	1
20406	Ø 3,5 mm	1	20417	Ø 7,0 mm	1	20428	Ø 12,0 mm	1
20407	Ø 3,8 mm	1	20418	Ø 7,5 mm	1	20429	Ø 12,5 mm	1
20408	Ø 4,0 mm	1	20419	Ø 8,0 mm	1	20430	Ø 13,0 mm	1
20409	Ø 4,2 mm	1	20420	Ø 8,5 mm	1			
20410	Ø 4,5 mm	1	20421	Ø 9,0 mm	1			

DRILL HSS

HSS **DIN 338**



No.	specification	
19841	Ø 4,1 mm 5 pcs	10
19842	Ø 4,2 mm 5 pcs	10
19845	Ø 4,5 mm 5 pcs	10
19885	Ø 8,5 mm 1 pcs	10
19895	Ø 9,5 mm 1 pcs	10

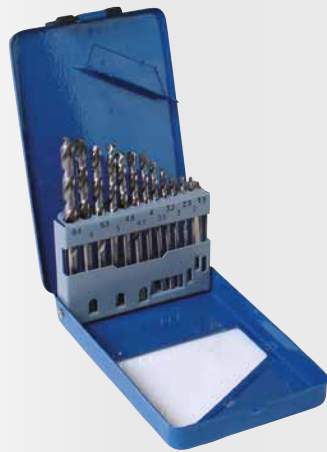

FESTA

FULLY GROUND
DRILL SET HSS

W 9%, Mo 3%
Cr 4%, V 1% **HSS** **DIN 338**

13x



No. specification
20333 Ø 1,5 - 6,5 mm

1



FESTA

DRILL SET

W 4%, Mo 3%
Cr 4%, V 1% **HSS** **DIN 338**

13x



No. specification
20336 Ø 1,5 - 6,5 mm

1



FESTA

FULLY GROUND
DRILL SET HSS

W 9%, Mo 3%
Cr 4%, V 1% **HSS** **DIN 338**

19x



No. specification
20334 Ø 1,0 - 10,0 mm

20



FESTA

DRILL SET

W 4%, Mo 3%
Cr 4%, V 1% **HSS** **DIN 338**

19x



No. specification
20337 Ø 1,0 - 10,0 mm

20



FESTA

FULLY GROUND DRILL
SET HSS

W 9%, Mo 3%
Cr 4%, V 1% **HSS** **DIN 338**

25x



No. specification
20335 Ø 1,0 - 13,0 mm

5



FESTA

DRILL SET

W 4%, Mo 3%
Cr 4%, V 1% **HSS** **DIN 338**

25x





No. specification
20338 Ø 1,0 - 13,0 mm

10





FESTA
DRILL SET

- TiN**
- INOX**   
- 9x**

No.	specification	
20317	Ø 5-6-8 mm	20 



FESTA
DRILL SET - WITH HEXAGON STALK

-  **1/4"** **HSS**
-  **ALU**
- 7x**

No.	specification	
20316	Ø 1,5-2-3-4-5-5,5-6 mm	20 



DRILL SET

- HSS** **DIN 338**
- 
- 19x**

No.	specification	
20305	Ø 1,0 - 13,0 mm	25 



DRILL SET

- HSS** **DIN 338**
- 
- 25x**

No.	specification	
20311	Ø 1,0 - 13,0 mm	10 



DRILL SET

- HSS** **DIN 338**
- 
- 13x**

No.	specification	
20300	Ø 1,5 - 6,5 mm	50 



DRILL SET

- HSS** **DIN 338**
- 
- 19x**

No.	specification	
20310	Ø 1 - 13 mm	10 



DRILL SET

TiN HSS DIN 338

INOX ALU

19x



No.	specification	
20320	Ø 1 - 10 x 0,5 mm	30



DRILL SET

HSS DIN 338

ALU

19x



No.	specification	
20321	Ø 1 - 10 x 0,5 mm	5



DRILL SET

HSS DIN 338

INOX

19x

No.	specification	
20315	Ø 1 - 10 mm	10



DRILL SHARPENER

No.	specification	
20380	for Ø 3,5 - 10 mm	20

FESTA

STEP DRILL TIN

TiN HSS



No.	specification	
20489	Ø 4 - 12 mm 8 steps	20
20490	Ø 4 - 20 mm 9 steps	10
20491	Ø 5 - 35 mm 13 steps	10
20492	Ø 7 - 40,5 mm 13 steps	5

STEP DRILL HSS

HSS

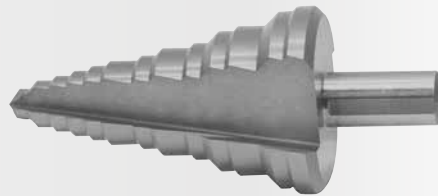

No.	specification	
20487	Ø 4 - 20 mm 9 steps	10
20488	Ø 5 - 35 mm 13 steps	10
20494	Ø 4 - 32 mm 15 steps	10
20493	Ø 7 - 40,5 mm 13 steps	1

FESTA

STEP DRILL SET TIN

TiN HSS



3x



No.	specification	
20495	Ø 4 - 12, 4 - 20, 4 - 32 mm	1

STEP DRILL SET

HSS



3x



No.	specification	
20496	Ø 4 - 12, 4 - 20, 4 - 32 mm	1



FESTA
HOLESAW HSS BI-METAL



No.	specification	
24419	Ø 19 mm	1
24420	Ø 20 mm	1
24422	Ø 22 mm	1
24425	Ø 25 mm	1
24429	Ø 29 mm	1
24432	Ø 32 mm	1
24435	Ø 35 mm	1
24437	Ø 37 mm	1
24444	Ø 44 mm	1
24451	Ø 51 mm	1
24457	Ø 57 mm	1
24464	Ø 64 mm	1
24476	Ø 76 mm	1
24483	Ø 83 mm	1



FESTA
HOLESAW HOLDER

No.	specification	
24410	for korunky 14 - 30 mm	1



FESTA
HOLESAW HOLDER

No.	specification	
24411	for korunky 32 - 152 mm	1



FESTA
SPARE DRILL FOR HOLESAW HOLDER

pro 24410, 24411

No.	Specification	
24412		5



FESTA
DRILLS HSS, HOLESAW BI-METAL - SET



9x

No.	specification	
24750	Ø 19, 22, 29, 38, 44, 57 mm	10



FESTA
DRILLS HSS, HOLESAW BI-METAL - SET



13x

No.	specification	
24751	Ø 19, 22, 29, 35, 38, 44, 51, 57, 64 mm	10



FESTA
SCREW EXTRACTORS

- ∅ 4 mm ∅ 11 mm
- ∅ 4,5 mm ∅ 15 mm
- ∅ 6,5 mm ∅ 19 mm
- ∅ 7,5 mm ∅ 24 mm

8x



No.	specification	
20387		5



FESTA
SCREW EXTRACTORS

- ∅ 4 mm
- ∅ 4,5 mm
- ∅ 6 mm
- ∅ 7,5 mm
- ∅ 11 mm

5x



No.	specification	
20386		10



SCREW EXTRACTORS

- ∅ 4 mm
- ∅ 4,5 mm
- ∅ 6 mm
- ∅ 7,5 mm
- ∅ 11 mm

5x



No.	specification	
20385		10



TAPS RATCHET

No.	specification	
20397	M3 - M8	10



FESTA
DIE WRENCH

DIN 225

No.	specification	
20396	25 x 9 mm	10



FESTA
TAP WRENCH

DIN 1814

No.	specification	
20395	1 - 1/2; M3 - M12	10



FESTA
TAPS AND DIES SET

32x



No.	specification	
20391	M 3, 4, 5, 6, 8, 10, 12 mm	1



FESTA
TAPS SET

21x



No.	specification	
20390	M 3, 4, 5, 6, 8, 10, 12 mm	1

FESTA

MASONRY DRILL

· two drilling bit

DIN 8039

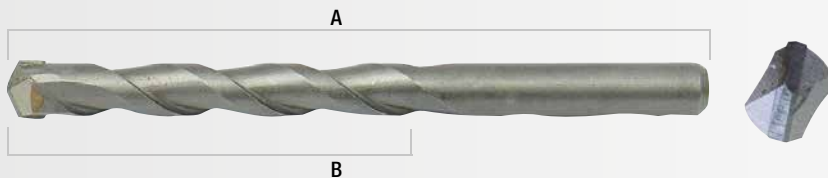

No.	specification	A mm	B mm	
20673	Ø 3 mm	60	30	100
20674	Ø 4 mm	75	40	100
20675	Ø 5 mm	85	50	100
20676	Ø 6 mm	100	60	100
20677	Ø 6 mm	200	160	50
20685	Ø 6 mm	300	260	50
20678	Ø 8 mm	120	75	50
20686	Ø 8 mm	200	155	50

No.	specification	A mm	B mm	
20687	Ø 8 mm	300	255	25
20688	Ø 8 mm	400	340	25
20680	Ø 10 mm	120	70	50
20690	Ø 10 mm	200	150	50
20691	Ø 10 mm	300	250	25
20692	Ø 10 mm	400	340	25
20682	Ø 12 mm	150	100	50
20694	Ø 12 mm	300	250	25

No.	specification	A mm	B mm	
20696	Ø 12 mm	400	340	25
20684	Ø 14 mm	150	90	25
	redukce Ø 10 mm			
20697	Ø 14 mm	300	240	5
	redukce Ø 10 mm			
20698	Ø 14 mm	400	340	15
	redukce Ø 10 mm			

FESTA

MASONRY DRILL SDS+

· two drilling bit

SDS+

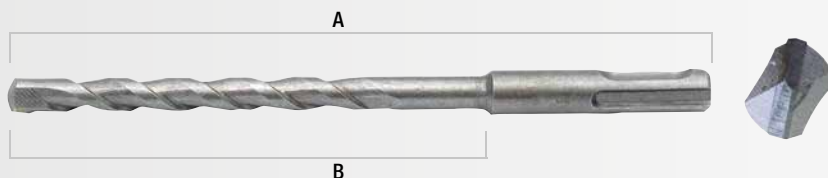

No.	specification	A mm	B mm	
20855	Ø 14 mm	160	75	25

FESTA

MASONRY DRILL SDS+

· four drilling bit with increment of feat and lifetime

SDS+

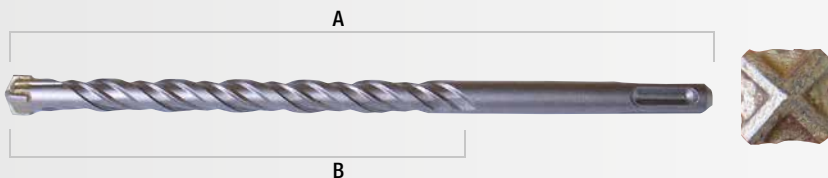

No.	specification	A mm	B mm	
20748	Ø 6 mm	110	40	50
20749	Ø 6 mm	160	90	50
20750	Ø 6 mm	210	140	50
20751	Ø 6 mm	260	190	50
20861	Ø 6,5 mm	230	160	50
20862	Ø 6,5 mm	300	230	50
20752	Ø 8 mm	110	40	50
20753	Ø 8 mm	160	90	50
20754	Ø 8 mm	210	140	50
20755	Ø 8 mm	260	190	50
20825	Ø 8 mm	350	280	50
20756	Ø 10 mm	160	90	50
20757	Ø 10 mm	210	140	50
20758	Ø 10 mm	260	190	50
20759	Ø 10 mm	350	280	50
20760	Ø 10 mm	450	380	50
20761	Ø 10 mm	600	530	50
20762	Ø 10 mm	1000	930	50
20764	Ø 12 mm	160	80	50
20765	Ø 12 mm	210	130	50
20766	Ø 12 mm	260	180	50
20767	Ø 12 mm	350	270	50

No.	specification	A mm	B mm	
20768	Ø 12 mm	460	380	50
20769	Ø 12 mm	600	520	25
20770	Ø 12 mm	1000	920	25
20771	Ø 14 mm	160	80	25
20772	Ø 14 mm	260	180	25
20773	Ø 14 mm	350	270	25
20774	Ø 14 mm	460	380	25
20775	Ø 14 mm	600	520	25
20776	Ø 14 mm	1000	920	30
20777	Ø 16 mm	160	80	25
20778	Ø 16 mm	210	130	25
20779	Ø 16 mm	260	180	25
20780	Ø 16 mm	350	270	25
20781	Ø 16 mm	460	380	25
20782	Ø 16 mm	600	520	30
20783	Ø 16 mm	1000	920	25
20784	Ø 18 mm	260	180	25
20785	Ø 18 mm	450	370	25
20786	Ø 18 mm	600	520	32
20787	Ø 18 mm	1000	920	20
20788	Ø 20 mm	450	370	20
20789	Ø 20 mm	600	520	20

No.	specification	A mm	B mm	
20790	Ø 20 mm	800	720	25
20791	Ø 20 mm	1000	920	10
20792	Ø 22 mm	450	365	20
20793	Ø 22 mm	600	520	20
20794	Ø 22 mm	800	715	20
20795	Ø 22 mm	1000	920	10
20796	Ø 24 mm	450	365	10
20797	Ø 24 mm	600	520	20
20798	Ø 24 mm	800	715	10
20799	Ø 24 mm	1000	920	10
20870	Ø 26 mm	450	370	10
20871	Ø 26 mm	650	570	20
20872	Ø 26 mm	800	720	10
20873	Ø 26 mm	1000	920	10
20874	Ø 28 mm	450	365	10
20875	Ø 28 mm	600	565	20
20876	Ø 28 mm	800	715	10
20877	Ø 28 mm	1000	915	10
20878	Ø 30 mm	450	365	10
20879	Ø 30 mm	600	565	20
20880	Ø 30 mm	800	715	10
20881	Ø 30 mm	1000	915	10

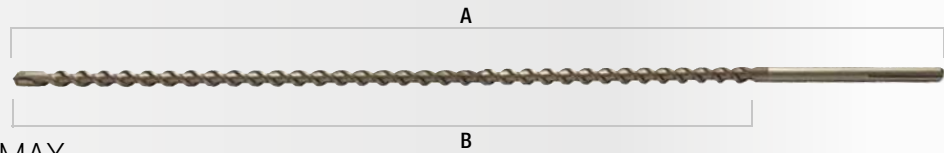

FESTA

MASONRY DRILL SDS MAX

• four drilling bit with increment of feat and lifetime

SDS MAX



No.	specification	A mm	B mm		No.	specification	A mm	B mm		No.	specification	A mm	B mm	
20508	NEW Ø 16 mm	550	395	5	20512	Ø 22 mm	550	395	5	20524	Ø 28 mm	800	650	5
20510	Ø 18 mm	550	395	5	20522	Ø 22 mm	800	650	5	20515	Ø 30 mm	550	395	5
20520	Ø 18 mm	800	650	5	20513	Ø 24 mm	550	395	5	20525	Ø 30 mm	800	650	5
20511	Ø 20 mm	550	395	5	20523	Ø 24 mm	800	650	5	20516	Ø 40 mm	550	395	2
20521	Ø 20 mm	800	650	5	20514	Ø 28 mm	550	395	5	20526	Ø 40 mm	800	650	1

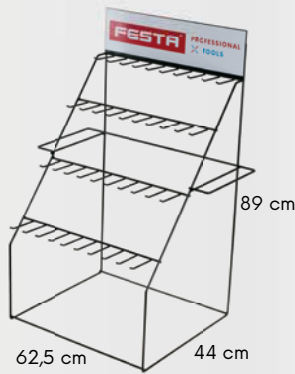

ADVERTISING STAND

No.	specification	
20999		1

MASONRY DRIL SET SDS+

SDS+

5x



No.	specification	
20890	Ø 5, 6, 8, 10, 12 mm 160 mm	25

MASONRY DRIL SET SDS+

SDS+

6x



No.	specification	
20891	Ø 5, 6, 8 mm 110 mm Ø 8, 10, 12 mm 160 mm	25

MASONRY DRIL SET

DIN 8039

6x



No.	specification	
20895	Ø 5, 6, 8, 10, 12 mm	25

MASONRY DRIL SET



No.	specification	
20805	5 pcs Ø 4 - 10 mm	10
20820	8 pcs Ø 3 - 10 mm	10



FESTA

MASONRY DRIL AND CHISEL SET SDS+

- gad
- chisel
- drill Ø 5-12 mm

SDS+



17x

No.	specification
20952	



FESTA

MASONRY DRIL AND CHISEL SET SDS+

- chisel 250 mm
- chisel hollow 22 x 250 mm
- flat 20 x 250 mm

- Ø 5 x 110 mm
- Ø 6 x 110 mm
- Ø 8 x 160 mm
- Ø 10 x 160 mm
- Ø 12 x 160 mm
- Ø 14 x 210 mm
- Ø 16 x 210 mm
- Ø 18 x 310 mm
- Ø 20 x 450 mm

SDS+



12x

No.	specification
20950	



FESTA

CHISEL SET

SDS+

4x

No.	specification
20954	250 mm



1

FESTA

FLAT CHISEL, 15° ANGLE

SDS+

No.	specification
20936	40 x 250 mm



5

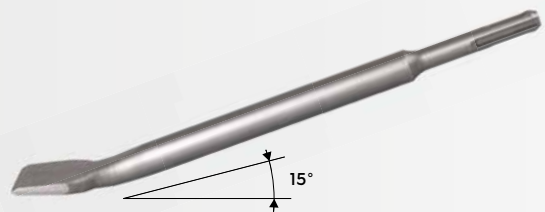



FESTA

CHISEL

SDS MAX



No.	specification	
20940	25 x 280 mm	5
20941	40 x 280 mm	5
20942	75 x 280 mm	5
20943	25 x 400 mm	5
20944	40 x 400 mm	5
20945	25 x 600 mm	5
20946	50 x 600 mm	5



FESTA

FLAT CHISEL

SDS+



No.	specification	
20948	20 x 250 mm	25
20990	20 x 400 mm	25
20949	40 x 250 mm	25
20991	40 x 400 mm	25



FESTA

HAMMER CHISEL

SDS MAX



No.	specification	
20937	Ø 18 x 280 mm	5
20938	Ø 18 x 400 mm	5
20939	Ø 18 x 600 mm	2



FESTA

HAMMER CHISEL

SDS+



No.	specification	
20947	250 mm	25
20992	400 mm	25



FESTA

CLAMPING CLIP FOR DRILL BITS

SDS MAX



No.	specification	
24730	180 mm	1



FESTA

CHISEL

SDS+



No.	specification	
20956	22 x 250 mm	25



FESTA

CLAMPING CLIP FOR DRILL BITS

SDS+



No.	specification	
24731	300 mm	1
24732		1



FESTA

ADAPTER SDS+ + NA BIT 1/4"

SDS+



No.	specification	
20743	75 mm	1



ADAPTER SDS MAX TO SDS+

SDS MAX



No.	specification	
20744		1

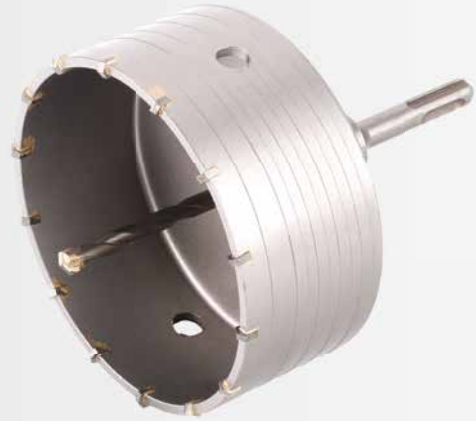

FESTA

MASONRY HOLESAW WITH TC TOOTH

- clamping clip for drill bits 24730, 24731 a 24732

SDS+



No.	specification	
24719	Ø 67 mm	1
24717	Ø 73 mm	1
24723	Ø 80 mm	1
24718	Ø 100 mm	1
24757	Ø 115 mm	1
24758	Ø 125 mm	1
24759	Ø 150 mm	1



HOLESAW

No.	specification	
24725	Ø 20-95mm	10



HOLESAW WITH COVER

No.	specification	
24726	Ø 20-95mm	1



FESTA

HOLESAW SET



8x

No.	specification	
24747	Ø 33, 53, 67, 73, 83 mm driving peg, drill, file	1



FESTA

HOLESAW SET FOR TILES



6x

No.	specification	
24745	Ø 33, 53, 67, 73 mm driving peg, drill	1

FESTA

HOLESAW



No.	specification	
24735	Ø 33 mm	1
24736	Ø 43 mm	1
24737	Ø 53 mm	1
24738	Ø 67 mm	1
24739	Ø 73 mm	1
24740	Ø 83 mm	1
24741	Ø 103 mm	1



FESTA

HOLESAW SET FOR TILES

3x



No.	specification	
24746	Ø 103 mm + driving peg, drill	1



FESTA

DRIVING PEG FOR HOLESAW



No.	specification	
24748	Ø 33 - 83 mm	10
24743	Ø 33 - 103 mm	10

FESTA

DRILL FOR HOLESAW



No.	specification	
24749		50



FILE FOR TILES, ROUND



No.	specification	
22200	200 mm	20



FILE FOR TILES, FLAT

· for grinding bricks before inserting a wall anchor



No.	specification	
22201	200 mm double asperity	20

FESTA

CARBIDE HOLESAW

· for glass and ceramics drilling
· cooling required



No.	specification	
24770	Ø 4 mm	1
24771	Ø 6 mm	1
24772	Ø 8 mm	1
24773	Ø 10 mm	1
24774	Ø 12 mm	1



DRILLING AND BORING CROW LEADER

No.	specification	
20379	Ø 4, 5, 6, 7, 8, 10, 12 mm	10



NEW



FESTA

DIAMOND HOLESAW

M14



- ceramic tiles
- marble
- granite



• no need to cool with water



No.	specification	üchyt	
24760	Ø 6 mm	M14	1
24761	Ø 8 mm	M14	1
24762	Ø 10 mm	M14	1
24763	Ø 12 mm	M14	1
24764	Ø 14 mm	M14	1
24670 NEW	Ø 16 mm	M14	1
24671 NEW	Ø 18 mm	M14	1
24790	Ø 20 mm	M14	1
24672 NEW	Ø 22 mm	M14	1
24673 NEW	Ø 25 mm	M14	1
24765	Ø 28 mm	M14	1
24674 NEW	Ø 30 mm	M14	1

No.	specification	üchyt	
24675 NEW	Ø 32 mm	M14	1
24766	Ø 35 mm	M14	1
24776 NEW	Ø 40 mm	M14	1
24767	Ø 45 mm	M14	1
24791	Ø 50 mm	M14	1
24768	Ø 53 mm	M14	1
24792	Ø 60 mm	M14	1
24793	Ø 65 mm	M14	1
24769	Ø 68 mm	M14	1
24794	Ø 75 mm	M14	1
24796	Ø 83 mm	M14	1
24676 NEW	Ø 110 mm	M14	1

FESTA

DIAMOND HOLESAW - SET

- Ø 8 mm
- Ø 10 mm
- Ø 14 mm
- Ø 22 mm
- Ø 32 mm
- Ø 40 mm
- Ø 68 mm

7x M14



- ceramic tiles
- marble
- granite



• no need to cool with water



No.	Specification	
24650		1



FESTA

DIAMOND HOLESAW



- ceramic tiles
- marble
- granite



No.	specification	
24700	Ø 6 mm	1
24701	Ø 8 mm	1
24702	Ø 10 mm	1
24703	Ø 12 mm	1
24704	Ø 14 mm	1
24705	Ø 20 mm	1

FESTA

DIAMOND HOLESAW - SET

6x



- ceramic tiles
- marble
- granite



No.	specification	
24798	Ø 6, 8, 10, 12, 14, 20 mm	1

NEW

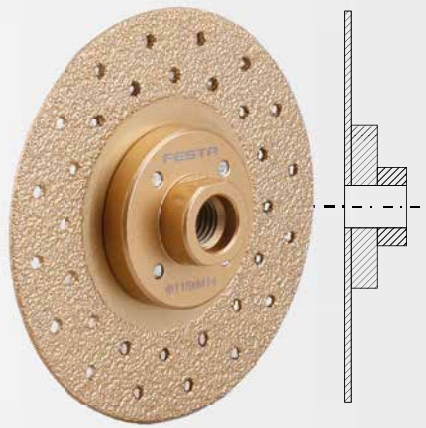

FESTA
DIAMOND DISC
CUTTING AND
GRINDING

M14

- ceramic tiles
- marble
- granite

- no need to cool with water

No.	Specification		
24655	Ø 115 mm	M14	1

NEW

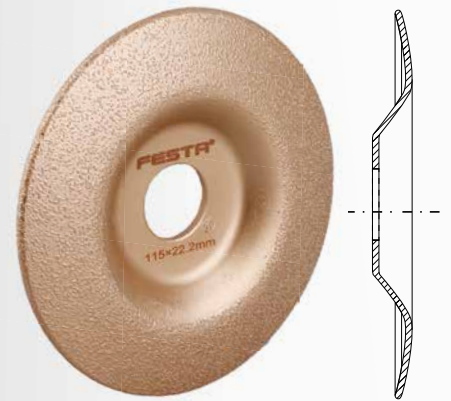

FESTA
DIAMOND DISC
GRINDING

- ceramic tiles
- marble
- granite

- no need to cool with water

No.	Specification		
24658	Ø 115 mm	Ø 22,2 mm	1

NEW

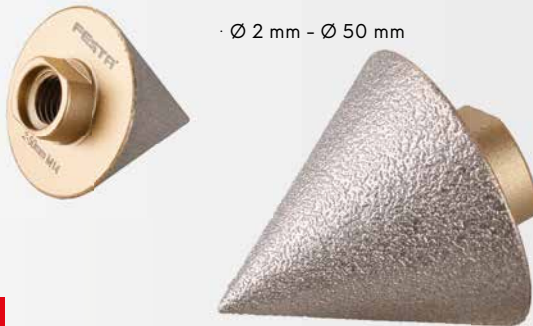

FESTA
DIAMOND GRINDING CONE

M14

- ceramic tiles
- marble
- granite

- no need to cool with water

No.	Specification		
24778	Ø 2 - 50 mm		1

NEW



FESTA
DIAMOND GRINDING CONE

M14

- ceramic tiles
- marble
- granite

- no need to cool with water

No.	Specification		
24779	Ø 20 - 48 mm		1

FESTA
DIAMOND GRINDING DRUM

M14

- ceramic tiles
- marble
- granite

- no need to cool with water

No.	specification		
24795	Ø 20 x 50 mm		1

FESTA
DRILL FOR GLASS
AND CERAMICS

TiN

1/4"

- ceramic tiles
- glass

No.	specification		
24780	Ø 4 mm		10
24781	Ø 5 mm		40
24782	Ø 6 mm		40
24783	Ø 8 mm		40
24784	Ø 10 mm		40
24785	Ø 12 mm		40
24786	Ø 14 mm		1
24787	Ø 16 mm		1
24788	Ø 18 mm		1
24789	Ø 20 mm		1



FESTA

SET OF PUNCHES AND CHISELS

CrV

12x

- 2, 6, 8 mm
- 10, 12, 16 mm
- Ø 1,5-3-4-5-6-8 mm

No.	specification	
19487		4

FESTA

SET OF CHISELS

CrV

6x

- 2 x 140, 8 x 115 mm
- 12 x 152, 10 x 142 mm
- Ø 3 x 152, 6 x 152 mm

No.	specification	
19486		10

FESTA

POINT CHISEL

CrV

No.	specification	
19429	200 mm	1

FESTA

SET OF CHISELS

CrV

3x

- 10, 12, 16 mm

No.	specification	
19485		10

FESTA

FLAT CHISEL

CrV

No.	specification	
19410	200 mm	10
19411	250 mm	10
19412	300 mm	10
19418	400 mm	5
19419	500 mm	5

FLAT CHISEL

CrV

No.	specification	
19436	200 mm	15



FESTA

SET OF PUNCHES

CrV 6x

No.	specification	
19483	Ø 3, 4, 5, 6, 7, 8 mm	5



FESTA

PUNCH SET

CrV 6x

No.	specification	
19482	Ø 3, 4, 5, 6, 8 mm	5



FESTA

PUNCH

CrV

No.	specification	
19472	Ø 4 mm 150 mm	1
19473	Ø 5 mm 150 mm	1
19474	Ø 6 mm 150 mm	1



FESTA

SET OF PUNCHES

CrV 3x

No.	specification	
19480	Ø 0.8, 1.5, 2.5 mm	10



FESTA

CENTRE PUNCH

CrV

No.	specification	
19477	Ø 2,5 mm	20



FESTA

CENTRE PUNCH SET

CrV 3x

No.	specification	
19481	Ø 0.8, 1.5, 2.5 mm	10



FESTA

CENTRE PUNCH AUTOMATIC

CrV

No.	specification	
19478	Ø 2,5 mm	12



GLASS CUTTER



No.	specification	
20350	130 mm	12



FESTA

AUGER BIT



No.	specification		No.	specification	
20980	Ø 6 x 230 mm	1	20984	Ø 16 x 230 mm	1
20957	Ø 6 x 300 mm	1	20899	Ø 16 x 300 mm	1
20981	Ø 8 x 230 mm	1	20917	Ø 16 x 450 mm	1
20958	Ø 8 x 300 mm	1	20922	Ø 16 x 600 mm	1
20982	Ø 10 x 230 mm	1	20918	Ø 18 x 450 mm	1
20896	Ø 10 x 300 mm	1	20923	Ø 18 x 600 mm	1
20913	Ø 10 x 450 mm	1	20919	Ø 20 x 450 mm	1
20983	Ø 12 x 230 mm	1	20924	Ø 20 x 600 mm	1
20897	Ø 12 x 300 mm	1	20724	Ø 22 x 450 mm	1
20915	Ø 12 x 450 mm	1	20725	Ø 24 x 450 mm	1
20920	Ø 12 x 600 mm	1	20726	Ø 26 x 450 mm	1
20898	Ø 14 x 300 mm	1	20727	Ø 28 x 450 mm	1
20916	Ø 14 x 450 mm	1	20728	Ø 30 x 450 mm	1
20921	Ø 14 x 600 mm	1			



FESTA

AUGER BIT SET



5x

No.	specification	
20911	Ø 8, 10, 12, 14, 16 x 460 mm	10



FESTA

AUGER BIT SET



6x

No.	specification	
20912	Ø 6, 8, 10, 12, 16, 20 x 230 mm	10



DRILL FOR WOOD



No.	specification		No.	specification		No.	specification	
20729	Ø 6 x 400 mm	1	20732	Ø 12 x 400 mm	1	20734	Ø 16 x 400 mm	1
20731	Ø 8 x 400 mm	1	20738	Ø 12 x 600 mm	1	20740	Ø 16 x 600 mm	1
20736	Ø 8 x 600 mm	1	20733	Ø 14 x 400 mm	1	20735	Ø 18 x 400 mm	1
20730	Ø 10 x 400 mm	1	20739	Ø 14 x 600 mm	1	20741	Ø 18 x 600 mm	1
20737	Ø 10 x 600 mm	1						



DRILL - WOOD



No.	specification	
21440	Ø 4 x 75 mm	1
21441	Ø 5 x 85 mm	1
21442	Ø 6 x 90 mm	1
21443	Ø 7 x 105 mm	1
21444	Ø 8 x 115 mm	1
21445	Ø 9 x 120 mm	1
21446	Ø 10 x 120 mm	1

WOOD DRILL SET



No.	specification	
20910	8 pcs Ø 3, 4, 5, 6, 7, 8, 9, 10 mm	10
20905	5 pcs Ø 4, 5, 6, 8, 10 mm	10



SAW DRILL

HSS TiN



No.	specification	
20460	Ø 6 mm	50

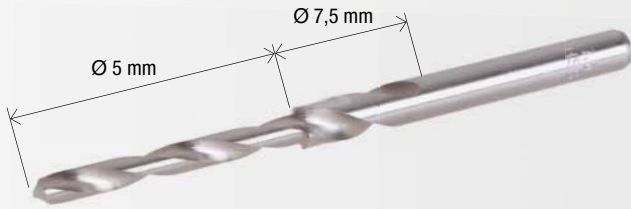

FESTA

FULLY GROUND DRILL

HSS



No.	specification	
20210	Ø 7.5, 5 mm	1

SAW DRILL SET

HSS TiN



6x



No.	specification	
20450	Ø 3, 4, 5, 6, 6.5, 8 mm	20



FLAT WOODEN DRILL SET



6x

No.	specification	
20901	Ø 10, 12, 16, 18, 20, 25 mm	20

FORSTNER BIT SET



5x

No.	specification	
21530	Ø 15, 20, 25, 30, 35 mm Ø 8 mm	20



ROUTER BIT SET



5x

No.	specification	
21450	Ø 8 mm	1



ROUTER BIT SET



12x

No.	specification	
21451	Ø 8 mm	1



ROUTER BIT SET



24x

No.	specification	
21452	Ø 8 mm	1



ROUTER BIT SET



35x

No.	specification
21453	Ø 8 mm



1



ROUTER BIT SET



59x

No.	specification
21454	Ø 8 mm



1



ROTARY RASP SET



5x

No.	specification
21541	



25



MOUNDED STONE SET

5x

No.	specification
21540	Ø 3 mm, 6 mm



12



GRINDING ACCESSORIES

100x

No.	specification
24755	



5



GRINDING ACCESSORIES

150x

No.	specification
24756	



10

NEW



· Ø 19 - 127 mm

FESTA

RING-SHAPED CROWN - ADJUSTABLE

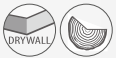

No.	Specification		
24415	Ø 19 - 127 mm	max. hloubka 29 mm	6

FESTA

HOLESAW SET

- Ø 19 mm
- Ø 22 mm
- Ø 25,5 mm
- Ø 36 mm
- Ø 44 mm
- Ø 51 mm
- Ø 60 mm
- Ø 67 mm
- Ø 76 mm
- Ø 82 mm
- hex key
- 2x head



No.	specification		
24712	6 tpi		20

FESTA

HOLESAW SET

- Ø 64 mm
- Ø 73 mm
- Ø 89 mm
- Ø 102 mm
- Ø 127 mm
- hex key
- head



No.	specification		
24706	6 tpi		20



FESTA
HOLESAW

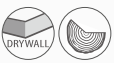

No.	specification	
24715	1' Ø 67 mm 6 tpi	5
24713	1' Ø 73 mm 6 tpi	5
24714	1' Ø 102 mm 6 tpi	5
24720	1' Ø 152 mm 6 tpi	5



HOLESAW SET



No.	specification	
24721	1' Ø 26, 32, 38, 45, 50, 56, 63 mm	10
24722	2' Ø 26, 32, 38, 45, 50, 56, 63 mm	10



ADJUSTABLE HOLESAW DRILL



No.	specification	
24716	Ø 30 - 120 mm	5



GIMLET SET - SET

HOBBY

4x

No.	specification	
20381	Ø 2, 3, 4, 5 mm	20



ADAPTER SDS MAX NA SDS +



No.	specification	
20744		1

ADAPTER SDS+



No.	specification	
20745		1



FESTA

CHUCK DRILL

1/2"



No.	specification	
20960	1-13 mm + 2 klíče, 1/2 - 20 UNF	3
20966	spare klíček	25



FESTA

DRILL CHUCK QUICKGRIP

1/2"



No.	specification	
20965	1,5 - 13 mm 1/2' - 20 UNF	1



DRILL CHUCK QUICKGRIP

1/2"



No.	specification	
20961	1,5 - 13 mm 1/2' - 20 UNF	1



ADAPTER FOR DRILLING 90°

No.	specification	
20365	Ø 1,0 - 10 mm	10



DRILL CHUCK QUICKGRIP FOR AKU

1/4"



No.	specification	
20963	Ø 1 - 6 mm	10



NUMBER PUNCH

No.	specification	
20972	6 mm	5
20973	8 mm	5



PUNCH SET

13x



No.	specification	
24695	Ø 5, 6, 8, 10, 11, 13, 16, 19, 22, 25, 28, 32, 35 mm	5



PUNCH SET

24690 - Ø 2,5 mm	24691 - Ø 2 mm
Ø 3 mm	Ø 2,5 mm
Ø 4 mm	Ø 3,2 mm
Ø 5 mm	Ø 4 mm
Ø 6 mm	Ø 4,8 mm
Ø 7 mm	Ø 5 mm
Ø 8 mm	Ø 6,4 mm
Ø 9 mm	Ø 8 mm
Ø 10 mm	Ø 9,5 mm
	Ø 11,1 mm
	Ø 12,7 mm
	Ø 14 mm
	Ø 15,8 mm
	Ø 19 mm
	Ø 22 mm

No.	specification	
24690	9 pcs Ø 2,5 - 10 mm	10
24691	15 pcs Ø 2 - 22 mm	5



LETTER PUNCH

No.	specification	
20970	6 mm	5
20971	8 mm	5



BRUSHES



20mm

FESTA
BEVEL BRUSH, BRASS COATED

· brass coated

M14					
No.	specification	wire			
21900	Ø 100 mm M14	s 0,3		60	
21902	Ø 125 mm M14	s 0,3		42	



10mm

FESTA
BEVEL BRUSH, BRASS COATED

· brass coated

M14					
No.	specification	wire			
22001	Ø 100 mm M14	s 0,3		60	
21901	Ø 125 mm M14	s 0,3		42	



FESTA
BEVEL BRUSH, BRASS

· brass

M14					
No.	specification	wire			
21920	Ø 100 mm M14	s 0,3		60	



FESTA
CUP BRUSH, BRASS COATED

· brass coated

M14					
No.	specification	wire			
21903	Ø 65 mm M14	s 0,3		60	
22002	Ø 75 mm M14	s 0,3		80	
21904	Ø 85 mm M14	s 0,3		60	
22003	Ø 100 mm M14	s 0,3		36	
21905	Ø 125 mm M14	s 0,3		24	
21906	Ø 150 mm M14	s 0,3		12	



FESTA
CUP BRUSH, BRASS

· brass

M14					
No.	specification	wire			
21925	Ø 75 mm M14	0,3 mm		80	
21926	Ø 100 mm M14	0,3 mm		36	



FESTA
RADIAL BRUSH, BRASS COATED

· brass coated

· reduction rings

No.	specification	wire		
22007	Ø 100 mm Ø 20 mm	s 0,3		60
22008	Ø 125 mm Ø 20 mm	s 0,3		42
22009	Ø 150 mm Ø 32,2 mm	s 0,3		32
22010	Ø 175 mm Ø 32,2 mm	s 0,3		20
22011	Ø 200 mm Ø 32,2 mm	s 0,3		20



FESTA

CUP BRUSH, KNOTTED

· hardened

M14



No.	specification	wire	
22004	Ø 65 mm M14	s 0,3	60
22005	Ø 75 mm M14	s 0,3	24
22006	Ø 100 mm M14	s 0,3	24
21907	Ø 125 mm M14	s 0,3	24
21908	Ø 150 mm M14	s 0,3	12



FESTA

CUP BRUSH, KNOTTED - INOX

· hardened

INOX M14



No.	specification	wire	
22037	Ø 65 mm M14	s 0,5	60
22038	Ø 80 mm M14	s 0,5	24



FESTA

RADIAL BRUSH, KNOTTED

· hardened

M14



No.	specification	wire	počet copů	
21911	Ø 100 mm M14	s 0,5	30	60
21912	Ø 115 mm M14	s 0,5	32	42
21913	Ø 125 mm M14	s 0,5	36	42
21914	Ø 150 mm M14	s 0,5	40	32



FESTA

RADIAL BRUSH, KNOTTED

· hardened

M14



No.	specification	wire	
22012	Ø 100 mm M14	s 0,5	60
22013	Ø 115 mm M14	s 0,5	42
22014	Ø 125 mm M14	s 0,5	42
22015	Ø 150 mm M14	s 0,5	32
22016	Ø 178 mm M14	s 0,5	20



FESTA

RADIAL BRUSH, KNOTTED

· hardened

INOX M14



No.	specification	wire	
22039	Ø 100 mm M14	s 0,5	60
22040	Ø 125 mm M14	s 0,5	42



FESTA

BEVEL BRUSH, KNOTTED

· hardened

M14



No.	specification	wire	
22017	Ø 100 mm M14	s 0,5	60
21909	Ø 115 mm M14	s 0,5	42
21910	Ø 125 mm M14	s 0,5	42



Ø 6 mm

FESTA

BEVEL BRUSH, KNOTTED

· hardened



No.	specification	wire	
22023	Ø 75 mm	s 0,5	10



Ø 6 mm

FESTA

CUP BRUSH KNOTTED, SHANK

· hardened



No.	specification	wire	
22024	Ø 75 mm	s 0,5	12



Ø 6 mm

FESTA

BEVEL BRUSH KNOTTED, SHANK

· hardened



No.	specification	wire	
22025	Ø 75 mm	s 0,5	12



FESTA

RADIAL BRUSH BRASS COATED

brass coated



No.	specification	wire	
22026	Ø 50 mm	s 0,3	15
22027	Ø 63 mm	s 0,3	15
22028	Ø 75 mm	s 0,3	10
22029	Ø 100 mm	s 0,3	15



FESTA

CUP BRUSH BRASS COATED

brass coated



No.	specification	wire	
22030	Ø 65 mm	s 0,3	12
22031	Ø 75 mm	s 0,3	12



FESTA

END BRUSH, KNOTTED

hardened



No.	specification	wire	
22021	Ø 19 mm	s 0,5	30
22022	Ø 22 mm	s 0,5	25



FESTA

END BRUSH, SHANK



No.	specification	wire	
22058	Ø 12 mm	s 0,3	25
22059	Ø 25 mm	s 0,3	25



FESTA

END BRUSH, SHANK

brass coated



No.	specification	wire	
22018	Ø 12 mm	s 0,3	15
22019	Ø 17 mm	s 0,3	15
22020	Ø 25 mm	s 0,3	25



FESTA

RADIAL BRUSH, NYLON

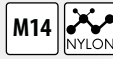

No.	specification	wire	
21930	Ø 125 mm	M14 1,2 mm	10
21931	Ø 150 mm	M14 1,2 mm	15



FESTA

CUP BRUSH, NYLON



No.	specification	wire	
21940	Ø 75 mm	M14 1,2 mm	1
21941	Ø 100 mm	M14 1,2 mm	1

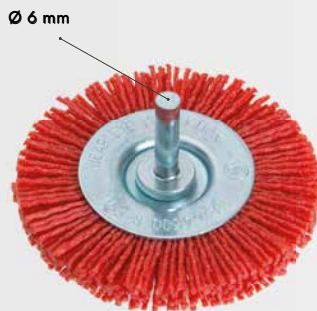

FESTA

RADIAL BRUSH, NYLON, STALK



No.	specification	wire	
21935	Ø 50 mm	1,2 mm	1
21936	Ø 75 mm	1,2 mm	1
21937	Ø 100 mm	1,2 mm	1

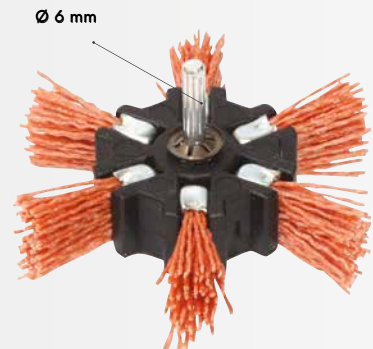

FESTA

FLAPPER BRUSH, NYLON, SHANK



No.	specification	wire	
22032	Ø 100 mm	1,2 mm	12



WIRE BRUSH

No.	specification	wire	
22158	200 mm	steel	1
22159	200 mm	brass	1



WIRE BRUSH, PLASTIC

No.	specification	wire	
22035	270 mm	steel	24
22036	270 mm	stainless steel	24



WIRE BRUSH

No.	specification	lines	
22033	300 mm	4 lines	12
22034	300 mm	5 lines	12



WIRE BRUSH BRASS

· brass coated		
No.	lines	
22078	3 lines	20



WIRE BRUSH BRASS

· brass coated			
No.	specification	lines	
22079	300 mm	4 lines	6



FESTA

WIRE BRUSH, PLASTIC

No.	specification	lines	
22080	270 mm	5 lines	12



FESTA

HAND BRUSH, BRASS

No.	specification	lines	
22082	300 mm	5 lines	12



WIRE BRUSH, STEEL, BRUSH COATED - SET

3x



No.	lines	
22081	3 lines	12



FESTA

WIRE BRUSH, STEEL, BRUSH COATED - SET

· nylon, inox, brass

3x



No.	specification	
22086	180 mm	12



FESTA

DIAMOND POLISHING DISC Ø 100 MM, WITH VELCRO

- ceramic tiles
- glass
- marble
- granite



No.	asperity	
22701	50	1
22702	100	1
22703	200	1
22704	400	1
22705	800	1
22706	1500	1
22707	3000	1



FESTA

BACKING PAD, BIND WITH VELCRO

- M14 | Ø 8 mm
- EVA 10 mm

M14



No.	specification	
22062	Ø 115 mm	25
22063	Ø 125 mm	25
22064	Ø 150 mm	10



FESTA

BACKING PAD FOR FIBER DISC



M14

No.	specification	
22073	Ø 125 mm, M14	1
22074	Ø 150 mm, M14	1



FESTA

BACKING PAD FOR DIAMOND POLISHING DISCS

- for angle grinding machine

M14



No.	specification	
22043	Ø 100 mm bind with velcro	1

BACKING PAD

- for angle grinding machine

M14

No.	specification	
22044	Ø 125 mm M14 bind with velcro	15
22060	Ø 150 mm M14 bind with velcro	6

ADAPTER

M14

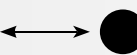

No.	specification	
22087		1



BACKING PAD



No.	specification	stopka shank	
22061	Ø 125 mm bind with velcro	Ø 8 mm	6



BACKING PAD



No.	specification	
22041	Ø 125 mm bind with screw	11
22042	Ø 125 mm bind with velcro	11



POLISHING PAD



No.	specification	specification	
22065	Ø 125 mm	bind with velcro	20
22066	Ø 150 mm	bind with velcro	20



FLAPPER BRUSH FLEECE



No.	specification	
22068	Ø 125 mm	20
22069	Ø 150 mm	20

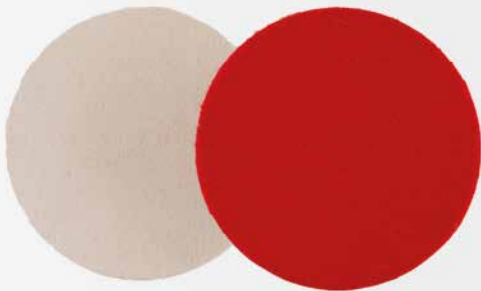

POLISHING FELT WITH VELCRO



No.	specification	
22070	Ø 115 mm	20
22071	Ø 125 mm	bind with velcro 20
22072	Ø 150 mm	20



Ø 6 mm

NYLON BRUSH DISK



No.	specification	
22091	Ø 50 mm P240	1
22092	Ø 75 mm P240	1
22093	Ø 100 mm P240	1



BRUSH NYLON WITH PAD



No.	specification	
21798	Ø 125 mm Ø 22,2 mm	1



Ø 6 mm

NYLON BRUSH DISC, SHANK



No.	specification	
22088	Ø 65 mm	9
22090	Ø 100 mm	5



BRUSH NYLON WITH PAD



No.	specification	
22083	Ø 115 mm Ø 22,2 mm	10
22084	Ø 125 mm Ø 22,2 mm	10
22085	Ø 150 mm Ø 22,2 mm	10



NYLON BRUSH DISC



No.	specification	
22095	Ø 178 mm	1



FESTA

FIBER DISC - Ø 125 MM

3x



No.	asperity	
22160	P40	1
22161	P60	1
22162	P80	1
22163	P100	1
22164	P120	1



FESTA

FIBER DISC - Ø 150 MM

3x



No.	asperity	
22166	P60	1
22167	P80	1
22168	P100	1



FESTA

SANDING PAPER Ø 125 MM, WITH VELCRO

3x



No.	asperity	
22045	P40	1
22046	P60	1
22047	P80	1
22048	P100	1
22049	P120	1
22050	P150	1
22051	P180	1
22052	P220	1



FESTA

SANDING PAPER Ø 150 MM, WITH VELCRO

3x



No.	asperity	
22053	P40	1
22054	P60	1
22055	P80	1
22056	P100	1
22057	P120	1



FESTA

VIBRATORY CUT
94 X 94 X 94 MM

5x



No.	asperity	
21831	P60	1
21832	P80	1
21834	P120	1



SANDING PAPER, WITH
VELCRO 125 MM

3x

No.	asperity	
22096	P40	20
22097	P60	20
22098	P80	20
22099	P120	20



FESTA

ENDLESS SANDING BELT
75 X 533 MM

3x



No.	asperity	
21810	P40	20
21811	P60	20
21812	P80	20
21813	P100	20
21814	P120	20

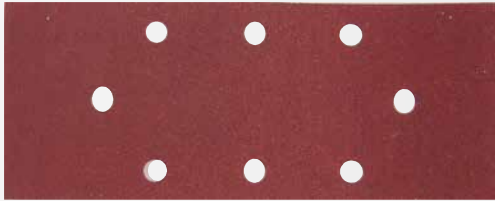

SANDING PAPER 93 X 230 MM

5x



No.	asperity	počet otvorů	
21740	P40	8	20
21741	P60	8	20
21742	P80	8	20
21743	P100	8	20
21744	P120	8	20

SANDING PAPER 115 X 280 MM

5x



No.	asperity	počet otvorů	
21750	P40	10	20
21751	P60	10	20
21752	P80	10	20
21753	P100	10	20
21754	P120	10	20

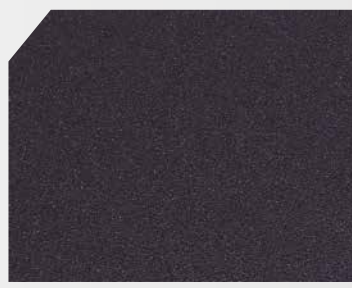
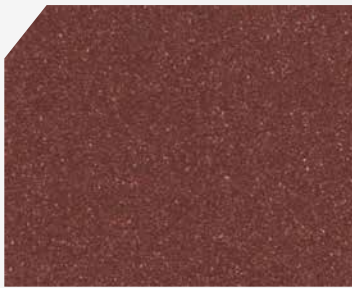

SANDING CLOTH 230 X 280 MM

10x

No.	asperity	
21732	P40	1
21734	P60	1
21735	P80	1
21736	P100	1
21737	P120	1

SANDING PAPER WATERPROOF 230 X 280 MM

10x

No.	asperity	
21701	P60	1
21702	P80	1
21703	P100	1
21704	P120	1
21705	P150	1
21706	P180	1
21709	P240	1

SANDING PAPER 230 X 280 MM

10x

No.	asperity	
21715	P40	1
21716	P60	1
21717	P80	1
21718	P100	1
21719	P120	1
21720	P150	1
21721	P180	1
21724	P240	1



FESTA

HOLDER FOR SANDING PAPER

· quick grip

No.	specification	
22067	170 x 70 mm	10

HOLDER FOR SANDING PAPER



No.	specification	
22075	210 x 105 mm	100
22076	160 x 85 mm	100

HOLDER FOR SANDING PAPER 125 X 68 MM

No.	specification	
22077	125 x 68 mm	10



FESTA

DIAMOND SANDING SPONGE BLOCK

- 90 x 55 x 25 mm
- ceramic tiles
- glass
- marble
- granite



No.	asperity	
22115	P60	10
22116	P120	10
22117	P200	10

GRINDING LAMELL DISC WITH SHANK

No.	asperity	specification	
21850	P40		1
21851	P60		1
21852	P80	20 x 20, Ø 6 mm	1
21853	P100		1
21854	P120		1
21855	P40		1
21856	P60		1
21857	P80	30x30, Ø 6mm	1
21858	P100		1
21859	P120		1
21860	P40		1
21861	P60		1
21862	P80	60x30, Ø 6mm	1
21863	P100		1
21864	P120		1

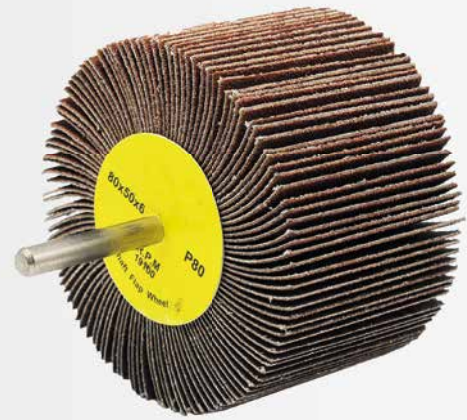

FESTA

SANDING SPONGE BLOCK 100 X 70 X 28 MM - BEVELED



No.	asperity	
22106	P 60	10
22107	P 80	10
22108	P 100	10
22109	P 120	10



FESTA

SANDING SPONGE BLOCK 100 X 70 X 25 MM



No.	asperity	
22100	P60	20
22101	P80	20
22102	P100	20
22103	P120	20
22104	P180	20
22105	P220	20



FESTA

SANDING SPONGE BLOCK 120 X 95 X 10 MM



No.	asperity	
22110	P80	20
22111	P120	20
22112	P180	20
22113	P220	20



DRYWALL TOOLS



DRYWALL RASP

No.	specification	
22120	250 x 40 mm	10



DRYWALL RASP

No.	specification	
22121	250 x 40 mm	10
22122	140 x 40 mm	6



DRYWALL RASP

No.	specification	
22126	155 x 40 mm	1



DRYWALL RASP

No.	specification	
22125	Ø 250 x 40 mm	6



DRYWALL RASP

No.	specification	
22124	Ø 250 x 16 mm	10



DRYWALL RASP

No.	specification	
22123	60 x 40 mm	6



FESTA
SAW FOR DRYWALL

No.	specification	
24159	150 mm	12



PLANE FOR DRYWALL

No.	specification	
34315		10
34316	spare blade	1



DRILLING SAW FOR DRYWALL

No.	specification	
24190	270 mm	10

DRILLING SAW FOR DRYWALL RASP

No.	specification	
22130	250 x 40 mm	20
22129	155 x 40 mm	20
22132	140 x 40 mm	20
22133	60 x 40 mm	20
22134	Ø 16 x 250 mm	20





RASP AND FILES



FESTA
FLAT FILE



No.	specification	asperity	
22206	150 mm	2	10
22180	250 mm	2	10



FESTA
FOURSQUARE FILE



No.	specification	asperity	
22184	250 mm	2	10



FESTA
TRIANGULAR FILE



No.	specification	asperity	
22183	250 mm	2	10



FESTA
CABINET FILE



No.	specification	asperity	
22207	150 mm	2	10
22182	250 mm	2	10



FESTA
TRIANGULAR FILE FOR SAW BLADES



No.	specification	asperity	
22178	150 mm	1	10



FESTA
ROUND FILE



No.	specification	asperity	
22181	250 mm	2	10



FESTA
FILE SET



5x



No.	specification	asperity	
22209	150 mm	2	10
22186	250 mm	2	5



FESTA
FILE SET



3x



No.	specification	asperity	
22208	150 mm	2	10
22185	250 mm	2	5



FESTA

FLAT RASP



No.	specification	
22202	150 mm	10
22197	300 mm	10



FESTA

ROUND RASP



No.	specification	
22204	150 mm	10
22205	250 mm	10
22198	300 mm	10



FESTA

CABINET RASP



No.	specification	
22203	150 mm	6
22199	300 mm	6



FESTA

RASP SET



3x



No.	specification	
22195	300 mm	5



FESTA

FILE FOR CHAIN SAW



No.	specification		No.	specification	
22170	200 mm 3,5 mm	10	22173	200 mm 5 mm	10
22171	200 mm 4 mm	10	22174	200 mm 5,5 mm	10
22172	200 mm 4,5 mm	10			



FESTA

NEEDLE FILE SET

10x



No.	specification	
22188		20



FESTA

SET FOR SHARPENING SAW CHAIN



No.	specification	
22190	300 mm	5



FESTA

DIAMOND FILE SET

10x



No.	specification	
22189		25



FESTA®

No.	specification	number of teeth	
Ø 115 mm			
22300	Ø 115 x 22 mm	40	1
Ø 125 mm			
22301	Ø 125 x 22 mm	40	1
Ø 140 mm			
22302	Ø 140 x 20 mm	24	1
22303	Ø 140 x 20 mm	30	1
Ø 150 mm			
22305	Ø 150 x 20 mm	24	1
Ø 160 mm			
22307	Ø 160 x 20 mm	18	1
22309	Ø 160 x 20 mm	24	1
22310	Ø 160 x 20 mm	30	1
22311	Ø 160 x 20 mm	36	1
22312	Ø 160 x 20 mm	48	1
22313	Ø 160 x 20 mm	60	1
Ø 165 mm			
22314	Ø 165 x 20 mm	24	1
Ø 180 mm			
22315	Ø 180 x 30 mm	24	1
22317	Ø 180 x 30 mm	50	1
22318	Ø 180 x 20 mm	50	1
Ø 190 mm			
22319	Ø 190 x 20 mm	40	1
22320	Ø 190 x 30 mm	40	1
Ø 200 mm			
22322	Ø 200 x 30 mm	24	1
22324	Ø 200 x 30 mm	40	1
22326	Ø 200 x 30 mm	60	1
Ø 205 mm			
22328	Ø 205 x 30 mm	40	1
22329	Ø 205 x 30 mm	60	1
Ø 210 mm			
22332	Ø 210 x 30 mm	40	1
22333	Ø 210 x 30 mm	60	1
Ø 250 mm			
22335	Ø 250 x 30 mm	40	1
22337	Ø 250 x 30 mm	60	1
Ø 300 mm			
22340	Ø 300 x 30 mm	40	1
22343	Ø 300 x 30 mm	60	1
22345	Ø 300 x 30 mm	96	1
Ø 350 mm			
22350	Ø 350 x 30 mm	40	1
22351	Ø 350 x 30 mm	54	1
Ø 400 mm			
22355	Ø 400 x 30 mm	40	1
22357	Ø 400 x 30 mm	60	1
Ø 500 mm			
22365	Ø 500 x 30 mm	60	1
Ø 600 mm			
22370	Ø 600 x 30 mm	60	1



FESTA

CIRCULAR SAW BLADE TCT

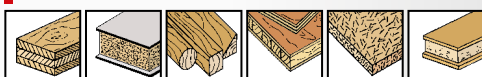

DISTANCE RING

No.	specification	
22399	Ø 20 16 mm	1
22398	Ø 30 25 mm	1





































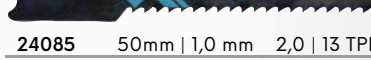



PROFESIONAL JIG SAW BLADES MADE IN GERMANY BY CAUTERIZING WITH LASER





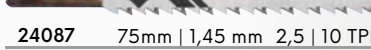



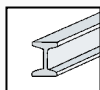

JIG SAW BLADES FIT JIG SAW LIKE: AEG, BOSCH, FESTO, MAKITA, METABO

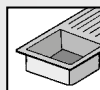
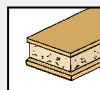
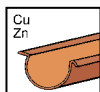
	24060	50mm/1mm	0,7 mm/ 36TPI	31007	5 pcs	10	
	24061	50mm/1mm	1,2 mm/ 21TPI	31012	5 pcs	10	
	24062	50mm/1mm	2,0 mm/ 13TPI	31020	5 pcs	10	
	24063	75mm/1mm	3,0 mm/ 8TPI	31030	5 pcs	10	
	24064	100mm/1mm	1,2 mm/ 21TPI	31112	5 pcs	10	
	24065	100mm/1,3mm	2,0 mm/ 13TPI	31112	5 pcs	10	
	24066	75mm/1,45mm	2,0 mm/ 13TPI	31220	5 pcs	10	
	24067	120mm/1,3mm	1,8 - 2,4 mm/ 10 - 14 TPI	31220	5 pcs	10	
	24068	75mm/1,45mm	2,5 mm/ 10 TPI	32225	5 pcs	10	
	24069	75mm/1,45mm	4 mm/ 6 TPI	32240	5 pcs	10	
	24070	75mm/1,3mm	4 mm/ 6 TPI	32340	5 pcs	10	
	24071	75mm/1,3mm	4 mm/ 6 TPI	32440	5 pcs	10	
	24072	75mm/1,45mm	2,5 mm/ 10 TPI	32625	5 pcs	10	
	24073	85mm/1,45mm	3 mm/ 8 TPI	32730	5 pcs	10	
	24074	85mm/1,45mm	4 mm/ 6 TPI	32730	5 pcs	10	
	32825	75mm/1,45mm	2,5 1,2 mm/10 21 TPI	32825	5 pcs	10	
	24076	75mm/1,7mm	4 mm 6 TPI	32940	5 pcs	10	
	24077	120mm/1,3mm	4 mm 6 TPI	32040	5 pcs	10	
	24078	105mm/1,45mm	4 mm 6 TPI	34040	5 pcs	10	
	24055	55mm	carbide		5 pcs	1	

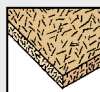
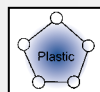
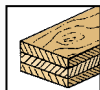
JIG SAW BLADES FIT JIG SAW LIKE: BLACK & DECKER, SKIL, FERM

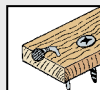
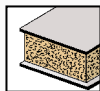
	24080	50mm 1,0 mm	1,2 21 TPI	11012	5 pcs	10				
	24081	75mm 1,0 mm	3,0 8 TPI	11030	5 pcs	10				
	24082	75mm 1,45 mm	2,5 10 TPI	12225	5 pcs	10				
	24083	75mm 1,45 mm	4 6 TPI	12240	5 pcs	10				
	24084	75mm 1,3 mm	4 6 TPI	12340	5 pcs	10				
	24085	50mm 1,0 mm	2,0 13 TPI	12420	5 pcs	10				
	24086	75mm 1,3 mm	4,0 6 TP	12440	5 pcs	10				
	24087	75mm 1,45 mm	2,5 10 TPI	12625	5 pcs	10				

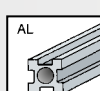
	mild steel		sheet metal		stainless steel		laminated boards
	non-ferrous-metals		hard and soft wood		chipboards		plastic
	plywood		batten board		nail infested wood		
	sandwichmaterial		tile		aluminium		

JIG SAW BLADES STAND

- items in stand - 24060 · 5 pcs
- 24080 · 5 pcs
- 24061 · 5 pcs
- 24062 · 5 pcs
- 24081 · 5 pcs
- 24063 · 5 pcs
- 24066 · 5 pcs
- 24067 · 5 pcs
- 24082 · 5 pcs
- 24068 · 5 pcs
- 24083 · 5 pcs
- 24069 · 5 pcs
- 24084 · 5 pcs
- 24070 · 5 pcs
- 24086 · 5 pcs
- 24071 · 5 pcs
- 24087 · 5 pcs
- 24072 · 5 pcs
- 24073 · 5 pcs
- 24074 · 5 pcs
- 24075 · 5 pcs
- 24076 · 5 pcs



JIG SAW BLADES SET



5x		
No.	specification	
24045	sada	50

No.	specification	
24099	64 x 50 cm - without blades	1
24098	64 x 50 cm - with blades	1

FESTA

SAW BLADE

HCS 3x

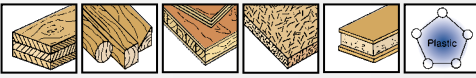

No. specification
24301 150 x 19 x 1,3 mm TPI 6

1

FESTA

SAW BLADE

HCS 3x

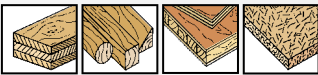

No. specification
24302 225 x 19 x 1,3 mm TPI 3

1

FESTA

SAW BLADE

HCS 3x

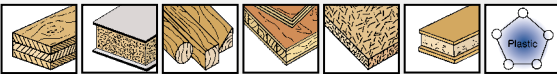

No. specification
24303 200 x 19 x 1,3 mm TPI 6 - 10

1

FESTA

SAW BLADE

HCS 3x

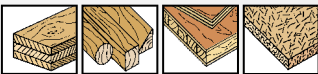

No. specification
24304 240 x 19 x 1,5 mm TPI 5

1

FESTA

SAW BLADE

Bi Metal 3x

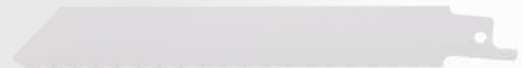
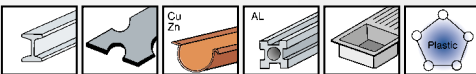

No. specification
24305 150 x 19 x 1 mm TPI 24

1

FESTA

SAW BLADE

Bi Metal 3x

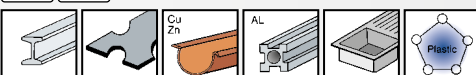

No. specification
24306 150 x 19 x 1 mm TPI 9

1

FESTA

SAW BLADE

Bi Metal 3x

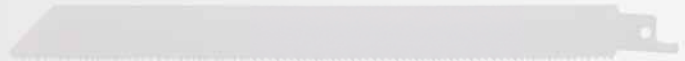
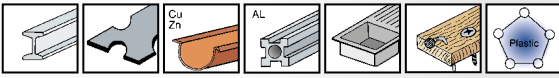

No. specification
24308 225 x 19 x 1 mm TPI 10 - 14



FESTA

SAW BLADE

Bi Metal 3x

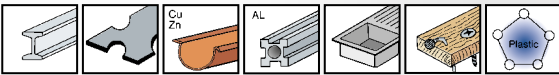

No. specification
24310 150 x 22 x 1,6 mm TPI 9



FESTA

SAW BLADE

Bi Metal 3x

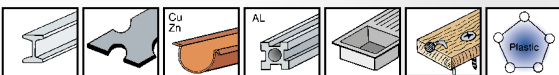

No. specification
24313 225 x 22 x 1,6 mm TPI 6



FESTA

HSS JIG SAW FOR METALS

HSS

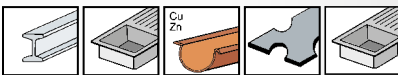

No. specification
24050 203 x 19 x 1 mm TPI 10 - 14



FESTA

SAW BLADE

• carbide technology, long life

TC 3x

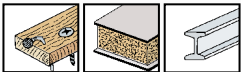

No. specification
24312 225 x 19 x 1,3 mm TPI 6 - 9



FESTA

SAW BLADE

TC



No. specification
24315 305 x 50 x 1,5 mm
24316 455 x 50 x 1,5 mm



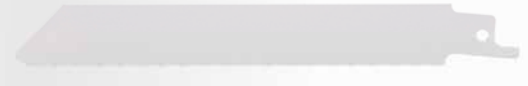
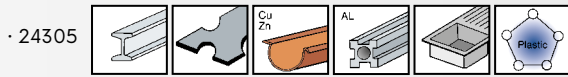
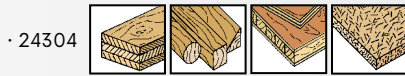
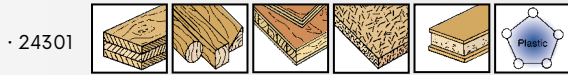

FESTA

SAW BLADE SET

Bi Metal HCS 3x



No.	specification	
24314		1



HACKSAW BLADE

· heat treated teeth



No.	specification	
24185	533 mm	1
24186	610 mm	1
24187	760 mm	1
24188	800 mm	1
24189	914 mm	1



FESTA

SAW BLADE

· heat treated teeth



No.	specification	
24169	350 mm	10
24167	450 mm	10
24166	533 mm	10
24163	610 mm	10
24164	760 mm	10
24168	800 mm	10
24165	914 mm	10



HACKSAW BLADE



No.	specification	
24195	span 3 mm 300 mm	1
24196	span 4 mm 300 mm šikmý zub angled tooth	1
24197	span 5 mm 300 mm kalený zub hardened tooth	1
24192	blade for butcher saw 450 mm	1



HACKSAW BLADE

No.	specification	
24160	span 3 mm 300 mm	20
24161	span 4 mm 300 mm	20
24162	span 5 mm 300 mm	50



HACKSAW BLADE

10x



No.	specification	
24108	6 mm 150 mm	1



ROD SAW BLADE



No.	specification	
24120	300 mm	50



FESTA

SAW BLADE BI - METAL

8 % COBALT



No.	specification
24180	300 mm



125

FESTA

HACKSAW BLADE



MOQ

No.	specification		
24109	12,5 mm 300 mm	for metal	144
24118	25 mm 300 mm	for metal double sided	72
24119	25 mm 300 mm	for metal and wood	72

FESTA

METAL HAND SAW



No.	specification
24104	300 mm



6

FESTA

METAL HAND SAW

· heavy duty



No.	specification
24102	300 mm



6

HAND SAW FOR METAL



No.	specification
24153	300 mm

12

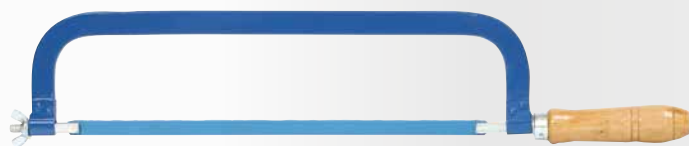

HAND SAW FOR METAL



No.	specification
24100	300 mm

12





HAND SAW FOR METAL



No.	specification	
24170	300 mm	12



FESTA
HAND SAW FOR METAL



2x



No.	specification	
24126	300 x 25 x 0,65 mm TPI 24 14	10



HACKSAW

· blades 24108



No.	specification	
24125	150 mm	6



HACKSAW

· blades 24109



No.	specification	
24124	260 mm	12



HAND SAW

No. No.	specification	
24121	saw	12
24110	saw blade	30



HAND SAW

· 5x saw blade

No. No.	specification	
24122	saw	20
24111	saw blade	30

FESTA

HAND SAW



· 3 x sharpened and heat treated teeth



No.	specification	
24143	300 mm	12
24144	400 mm	12
24145	500 mm	12

FESTA

TENON SAW



· 3 x sharpened and heat treated teeth



No.	specification	
24147	300 mm	6

FESTA

WOOD HAND BOARD SAW



· 3 x sharpened and heat treated teeth



No.	specification	
24149	300 mm	12

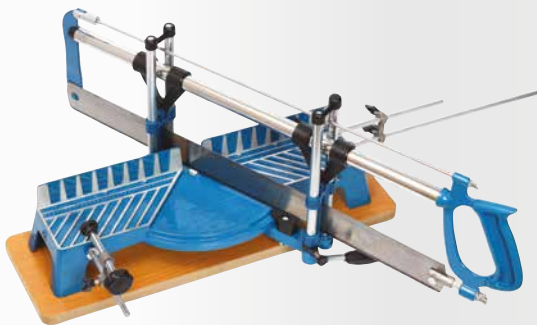

MITER SAW



No.	specification	
24130	600 mm	1
24131	600 mm, saw blade	1



MITER BOX PLASTIC



No.	specification	
24133	300 x 140 mm	18



MITER BOX WOODEN



No.	specification	
24171	80 x 300 mm	10



MITER BOX PLASTIC + SAW



No.	specification	
24148	300 mm	25



FESTA

PRUNING SAW

· heat treated teeth

No.	specification		No.	specification	
24141	450 mm	12	24136	760 mm	12
24140	533 mm	12	24142	800 mm	12
24135	610 mm	12	24137	914 mm	12

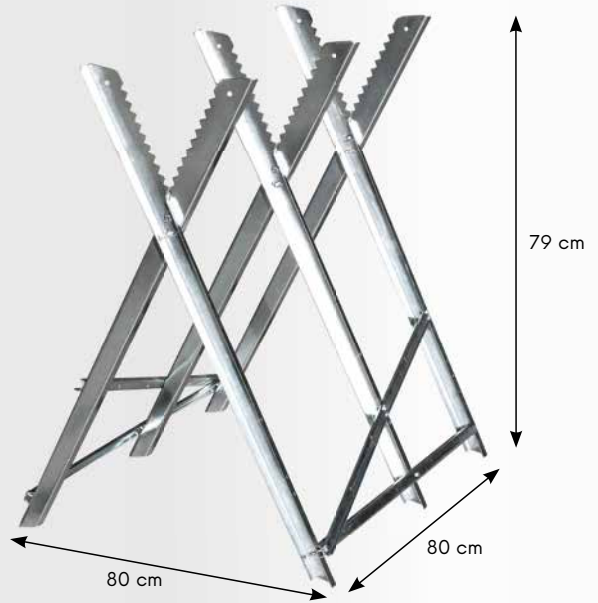

FESTA

SWIVEL SAW

· heat treated teeth

No.	specification	
24173	350 mm	24

WOOD CUTTING STAND



No.	specification	
37570	max. 150 kg	3



PRUNING HAND SAW



No.	specification	
24151	300 mm	10

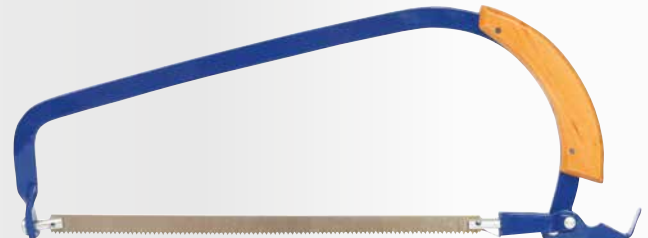

PRUNING SAW



No.	specification	
24150	300 mm	5

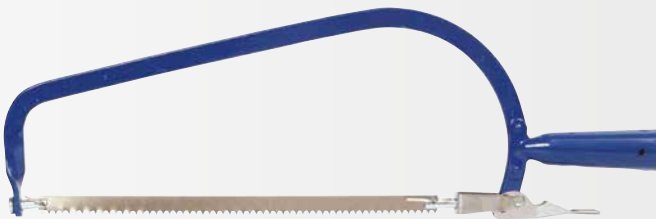

PRUNING HAND SAW



No.	specification	
24154	300 mm	10



SAW

No.	specification	
24128	450 mm blades 24192	6



FESTA

FOLDING SAW

· 3 x sharpened and heat treated teeth

No.	specification	
45061	150 mm with cover of handle	12

FESTA

FOLDING SAW

· 3 x sharpened and heat treated teeth

No.	specification	
45060	180 mm	6



FESTA

SAW WITH CASE

· 3 x sharpened and heat treated teeth

No.	specification	
45062	260 mm with case	24

FESTA

PRUNING HAND SAW

· 3 x sharpened and heat treated teeth

No.	specification	
24152	350 mm 7 tpi	12



FESTA

TELESCOPIC POLE SAW

· 3 x sharpened and heat treated teeth

No.	specification	
45033	230 - 490 mm	1



CATTERPILAR WITH SAW

No.	specification	
45030	pilka 30 cm telescopic pole 260 cm	6
45031	pilka 30 cm	6

CATTERPILAR

No.	specification	
45032	metal caterpillar without saw	6



FESTA

POLYSTYRENE SAW

No.	specification	
24174	370 mm	1



FESTA

DRYWALL SAW



· 3 x sharpened and heat treated teeth



No.	specification	
24159	150 mm	12



DRILLING SAW FOR DRYWALL



No.	specification	
24190	270 mm	10



FESTA

SAW FOR POROTHERM



No.	specification	
24181	550 mm	1



FESTA

CONCRETE SAW



No.	specification	
24158	22 22 SK teeth - 450 mm	5



FESTA

CONCRETE SAW



No.	specification	
24155	34 17 SK teeth - 630 mm	2
24156	34 34 SK teeth - 630 mm	2



FESTA

CONCRETE SAW

No.	specification	
24176	34 17 SK teeth - 750 mm	6
24177	34 34 SK teeth - 750 mm	6



FESTA

CONCRETE SAW





· heat treated teeth



No.	specification	
24175	without SK teeth - 600 mm EU	2
24178	without SK teeth - 600 mm	6

FESTA®



Using cutting diamond blades				
materials	festa industry	full	turbo	segment
brick	••	••	••	••
tile	••	•••	••	-
stone	••	••	••	••
concrete	•••	•	•••	•••
reinforced concrete	-	-	•••	-
roof tiles	••	•	••	••
glass and ceramics	-	•••	-	-
marble	•	••	•	•
granite	•••	••	•••	••
sandstone	••	-	••	••
asphalt	-	••	-	••
quartz	••	•	••	•



FESTA
INDUSTRY
DIAMOND DISC FESTA INDUSTRY

No.	specification			
21200	Ø 115 mm 1,4 mm	Ø 22,2 mm	1	
21201	Ø 125 mm 1,4 mm	Ø 22,2 mm	1	
21204	Ø 200 mm 1,8 mm	Ø 25,4 mm	1	
21203	Ø 230 mm 1,8 mm	Ø 22,2 mm	1	



FESTA
DIAMOND DISC FULL

No.	specification			
21210	Ø 110 mm Ø 22,2 mm	1		
21211	Ø 115 mm Ø 22,2 mm	1		
21212	Ø 125 mm Ø 22,2 mm	1		
21215	Ø 150 mm Ø 22,2 mm	1		
21218	Ø 180 mm Ø 22,2 mm	1		
21219	Ø 180 mm Ø 25,4 mm	1		
21220	Ø 200 mm Ø 25,4 mm	1		
21223	Ø 230 mm Ø 22,2 mm	1		
21224	Ø 300 mm Ø 25,4 mm	1		





FESTA

DIAMOND DISC SEGMENTED

No.	specification		
21311	Ø 115 mm Ø 22,2 mm		1
21312	Ø 125 mm Ø 22,2 mm		1
21315	Ø 150 mm Ø 22,2 mm		1
21318	Ø 180 mm Ø 22,2 mm		1
21323	Ø 230 mm Ø 22,2 mm		1
21324	Ø 300 mm Ø 25,4 mm		1
21327	Ø 350 mm Ø 25,4 mm		1
21326	Ø 400 mm Ø 25,4 mm		1



FESTA

DIAMOND DISC TURBO

No.	specification		
21410	Ø 110 mm Ø 22,2 mm		1
21411	Ø 115 mm Ø 22,2 mm		1
21412	Ø 125 mm Ø 22,2 mm		1
21415	Ø 150 mm Ø 22,2 mm		1
21418	Ø 180 mm Ø 22,2 mm		1
21423	Ø 230 mm Ø 22,2 mm		1
21424	Ø 300 mm Ø 25,4 mm		1



FESTA

UNIVERSAL DIAMOND CUTTING DISC



No.	specification		
21301	Ø 125 mm Ø 22,2 mm 1,5 mm		1
21303	Ø 230 mm Ø 22,2 mm 1,8 mm		1



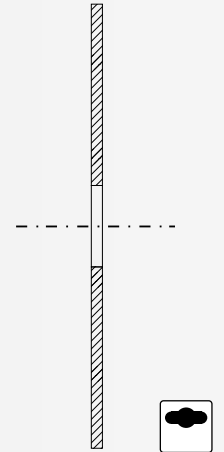

DIAMOND DISC FULL

No.	specification	
21010	Ø 110 mm Ø 22,2 mm	1
21011	Ø 115 mm Ø 22,2 mm	1
21012	Ø 125 mm Ø 22,2 mm	1
21015	Ø 150 mm Ø 22,2 mm	1
21018	Ø 180 mm Ø 22,2 mm	1
21023	Ø 230 mm Ø 22,2 mm	1

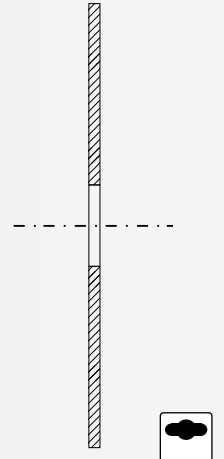

DIAMOND DISC SEGMENTED

No.	specification	
21110	Ø 110 mm Ø 22,2 mm	1
21111	Ø 115 mm Ø 22,2 mm	1
21112	Ø 125 mm Ø 22,2 mm	1
21115	Ø 150 mm Ø 22,2 mm	1
21118	Ø 180 mm Ø 22,2 mm	1
21123	Ø 230 mm Ø 22,2 mm	1

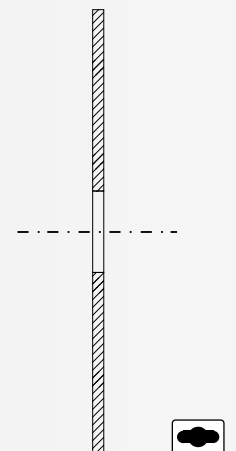

DIAMOND DISC TURBO

No.	specification	
21130	Ø 110 mm Ø 22,2 mm	1
21135	Ø 115 mm Ø 22,2 mm	1
21140	Ø 125 mm Ø 22,2 mm	1
21150	Ø 150 mm Ø 22,2 mm	1
21180	Ø 180 mm Ø 22,2 mm	1
21190	Ø 230 mm Ø 22,2 mm	1



FESTA

DIAMOND DISC GRINDING DOUBLE BRESED



No.	specification		
21430	Ø 115 mm	Ø 22,2 mm	1
21431	Ø 125 mm	Ø 22,2 mm	1
21432	Ø 150 mm	Ø 22,2 mm	1



FESTA

DIAMOND DISC GRINDING TURBO



No.	specification		
21425	Ø 100 mm	Ø 22,2 mm	1
21426	Ø 115 mm	Ø 22,2 mm	1
21427	Ø 125 mm	Ø 22,2 mm	1
21428	Ø 150 mm	Ø 22,2 mm	1



6 mm

FESTA

DIAMOND DISCS SEGMENTED, DOUBLE



No.	specification		
21195	Ø 125 x 22,2 mm		1



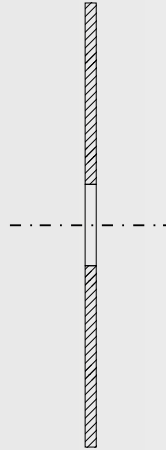

NEW



FESTA

CUTTING DISC FOR METAL



No.	specification			
22211	Ø 115 mm	Ø 22,2 mm x 1 mm	INOX	50
22212	Ø 115 mm	Ø 22,2 mm x 1,2 mm	INOX	50
22225	Ø 125 mm	Ø 22,2 mm x 1 mm	INOX	50
22217	Ø 125 mm	Ø 22,2 mm x 1,2 mm	INOX	50
No.	specification			
22251	Ø 115 mm	Ø 22,2 mm x 1,6 mm		50
22215	Ø 115 mm	Ø 22,2 mm x 2 mm		50
22216	Ø 115 mm	Ø 22,2 mm x 2,5 mm		50
22252	Ø 125 mm	Ø 22,2 mm x 1,6 mm		25
22218	Ø 125 mm	Ø 22,2 mm x 2,5 mm		25
22219	Ø 150 mm	Ø 22,2 mm x 1,2 mm		25
22253	Ø 150 mm	Ø 22,2 mm x 1,6 mm		50
22220	Ø 150 mm	Ø 22,2 mm x 2,5 mm		50
22254	Ø 180 mm	Ø 22,2 mm x 1,6 mm		50
22222	Ø 180 mm	Ø 22,2 mm x 2,5 mm		25
22255	Ø 230 mm	Ø 22,2 mm x 1,6 mm		25
22224	Ø 230 mm	Ø 22,2 mm x 2,5 mm		25

FESTA

CUTTING DISC FOR METAL

10x



No.	Specification			
22228	Ø 115 mm	Ø 22,2 mm x 1 mm		1
22229	Ø 125 mm	Ø 22,2 mm x 1,2 mm		1

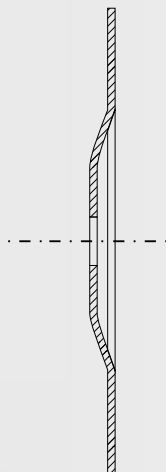

FESTA

GRINDING DISC FOR METAL



No.	specification			
22240	Ø 115 mm	Ø 22,2 mm x 6,4 mm		25
22242	Ø 125 mm	Ø 22,2 mm x 6,4 mm		25
22244	Ø 150 mm	Ø 22,2 mm x 6,4 mm		25
22246	Ø 180 mm	Ø 22,2 mm x 6,4 mm		25
22248	Ø 230 mm	Ø 22,2 mm x 6,4 mm		25

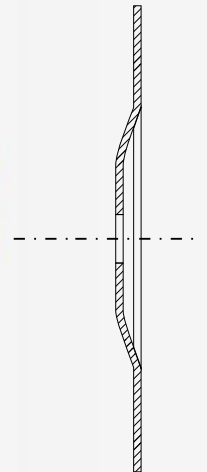

FESTA
INDUSTRY

CUTTING DISC FOR METAL



MADE IN EU **oSA**

No.	specification			
22258	NEW	Ø 115 mm	Ø 22,2 mm x 0,8 mm	25
22260		Ø 115 mm	Ø 22,2 mm x 1 mm	25
22263		Ø 115 mm	Ø 22,2 mm x 1,6 mm	25
22264	NEW	Ø 115 mm	Ø 22,2 mm x 2 mm	25
22259		Ø 125 mm	Ø 22,2 mm x 0,8 mm	25
22266		Ø 125 mm	Ø 22,2 mm x 1 mm	25
22269		Ø 125 mm	Ø 22,2 mm x 1,6 mm	25
22270		Ø 125 mm	Ø 22,2 mm x 2 mm	25
22273		Ø 150 mm	Ø 22,2 mm x 1,6 mm	25
22274		Ø 150 mm	Ø 22,2 mm x 2 mm	25
22275		Ø 150 mm	Ø 22,2 mm x 2,5 mm	25
22277		Ø 180 mm	Ø 22,2 mm x 2 mm	25
22280		Ø 230 mm	Ø 22,2 mm x 2 mm	25
22281		Ø 230 mm	Ø 22,2 mm x 2,5 mm	25

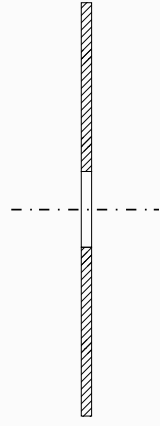
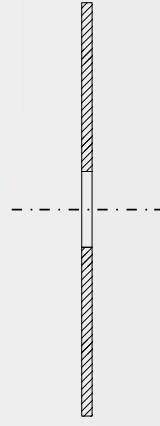

CUTTING DISC FOR ALUMINIUM



No.	specification	
22285	Ø 115 mm Ø 22,2 mm x 1 mm	1
22286	Ø 125 mm Ø 22,2 mm x 1 mm	1



CUTTING DISC FOR METAL - DIAMOND



No.	specification	
21306	Ø 125 mm Ø 22,2 mm 1,3 mm	1
21308	Ø 230 mm Ø 22,2 mm 1,8 mm	1



UNIVERSAL CUTTING DISC - CARBIDE



No.	specification	
21192	Ø 125 mm Ø 22,2 mm	1
21194	Ø 230 mm Ø 22,2 mm	1

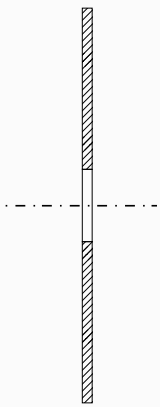

CUTTING DISC FOR STONE



No.	specification	
22294	Ø 230 mm Ø 22,2 mm x 3 mm	1



CUTTING DISC FOR STONE



No.	specification	
22230	Ø 115 mm Ø 22,2 mm x 2,5 mm	50
22232	Ø 125 mm Ø 22,2 mm x 2,5 mm	50
22234	Ø 150 mm Ø 22,2 mm x 2,5 mm	25
22236	Ø 180 mm Ø 22,2 mm x 2,5 mm	25
22238	Ø 230 mm Ø 22,2 mm x 2,5 mm	25

NEW

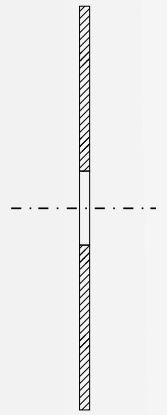

WOOD CARVING DISC



No.	Specification				
21804	Ø 125 mm	Ø 22,2 mm	14T		1

NEW

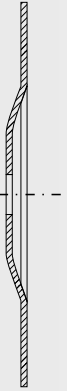

FESTA

SAW RASP DISC



No.	Specification				
21803	Ø 125 mm	Ø 22,2 mm			1

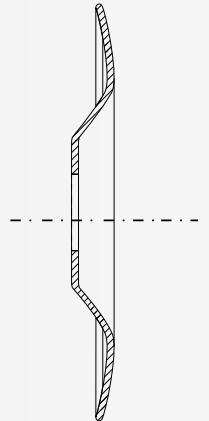

FESTA

RASP WHEEL - MEDIUM COARSE



No.	specification				
21802	Ø 125 mm	Ø 22,2 mm	3 mm		10



FESTA

RASP WHEEL - COARSE



No.	specification				
21801	Ø 125 mm	Ø 22,2 mm	3 mm		10

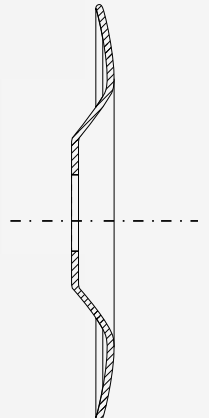

FESTA

DISC FOR WOOD WITH HOLES

· grinding disc suitable for grinding wood



No.	specification				
21800	Ø 125 mm	Ø 22,2 mm			1

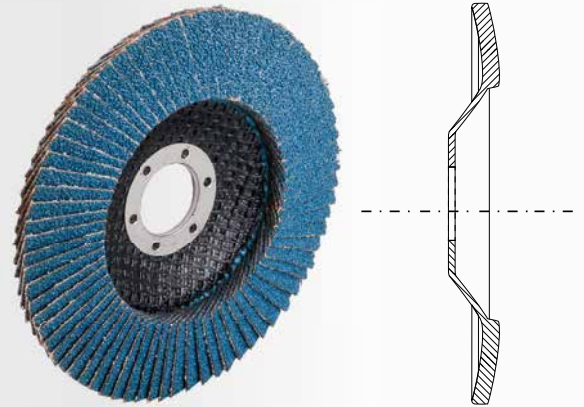
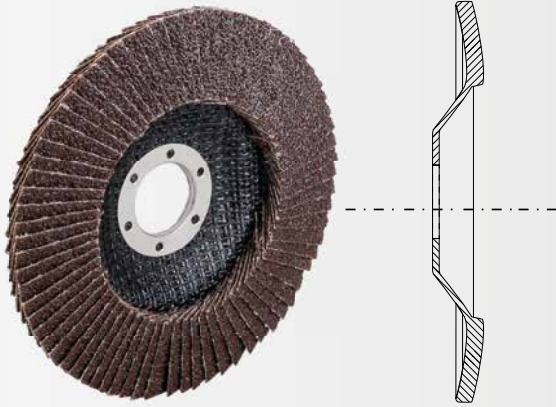

MULTI-PLATE DISC



No.	specification	asperity	
21780	Ø 115 mm Ø 22,2 mm	P40	10
21781	Ø 115 mm Ø 22,2 mm	P60	10
21782	Ø 115 mm Ø 22,2 m	P80	10
21783	Ø 115 mm Ø 22,2 mm	P100	10
21784	Ø 115 mm Ø 22,2 mm	P120	10
21786	Ø 125 mm Ø 22,2 mm	P40	10
21787	Ø 125 mm Ø 22,2 mm	P60	10
21788	Ø 125 mm Ø 22,2 mm	P80	10
21789	Ø 125 mm Ø 22,2 mm	P100	10
21790	Ø 125 mm Ø 22,2 mm	P120	10
21792	Ø 150 mm Ø 22,2 mm	P40	10
21793	Ø 150 mm Ø 22,2 mm	P60	10
21794	Ø 150 mm Ø 22,2 mm	P80	10
21795	Ø 150 mm Ø 22,2 mm	P100	10
21796	Ø 150 mm Ø 22,2 mm	P120	10

FESTA

MULTI-PLATE DISC

• grinding disc suitable for grinding stainless steel



No.	specification	asperity	
22140	Ø 115 mm Ø 22,2 mm	P40	5
22141	Ø 115 mm Ø 22,2 mm	P60	5
22142	Ø 115 mm Ø 22,2 mm	P80	5
22143	Ø 115 mm Ø 22,2 mm	P100	5
22145	Ø 125 mm Ø 22,2 mm	P40	5
22146	Ø 125 mm Ø 22,2 mm	P60	5
22147	Ø 125 mm Ø 22,2 mm	P80	5
22148	Ø 125 mm Ø 22,2 mm	P100	5
22150	Ø 150 mm Ø 22,2 mm	P40	5
22151	Ø 150 mm Ø 22,2 mm	P60	5
22155	Ø 150 mm Ø 22,2 mm	P80	5
22156	Ø 150 mm Ø 22,2 mm	P100	5



BRUSH NYLON WITH PAD



No.	specification	
21798	Ø 125 mm Ø 22,2 mm	1

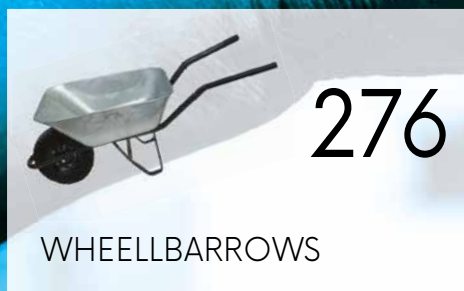



293

POLYSTYRENE CUTTER



298

PLASTERING SPLASH MACHINES



300

PB HEATERS AND PRESSURE REGULATORS



304

MASON TUBS

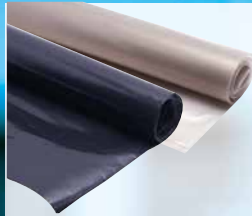

305

WASTE BAGS



306

TAPES



310

CAULKING GUNS



313

PU FOAM GUNS



314

HEATING GUNS AND HOT MELT GLUE GUNS

BUILDING TOOLS 242 - 329



316

PAINTER TOOLS



322

TARPAULINS



324

SNAP HOOPCS, CHAINS, WIRE ROPES



327

BUILDING LIGHTS



328

LADDERS



328

CHIMNEY DOORS AND ADJUSTABLE PROPS

TROWELS, PUTTY KNIVES AND SCRAPERS

FESTA
STAINLESS TROWEL 280 X 130 MM

· rubber handle



No.	specification	
31140	straight	10

FESTA
STAINLESS TROWEL 280 X 130 MM

· rubber handle



No.	specification	
31148	straight with rounded corners	10

FESTA
NOTCHED STAINLESS TROWEL 280 X 130 MM

· rubber handle



No.	specification	
31146	○ 16	10

FESTA
NOTCHED STAINLESS TROWEL 280 X 130 MM

· rubber handle



No.	specification		No.	specification	
31141	e 4	10	31144	e 10	10
31142	e 6	10	31145	e 12	10
31143	e 8	10			

FESTA
NOTCHED STAINLESS TROWEL 280 X 130 MM

No.	specification		No.	specification	
31101	e 4	10	31131	e 10	10
31111	e 6	10	31132	e 12	10
31121	e 8	10			

FESTA
STAINLESS TROWEL 280 X 130 MM

No.	specification	
31091	straight	10



FESTA

STAINLESS TROWEL 280 X 130 MM



No.	specification	
31011	straight	10



FESTA

NOTCHED STAINLESS TROWEL 280 X 130 MM



No.	specification		No.	specification	
31021	e 4	10	31051	e 10	10
31031	e 6	10	31053	e 12	10
31041	e 8	10			



STAINLESS TROWEL 270 X 125 MM



No.	specification	
31005	straight	25



NOTCHED STAINLESS TROWEL 270 X 125 MM



No.	specification		No.	specification	
31006	e 4	24	31008	e 8	24
31007	e 6	24	31009	e 10	24



FESTA

STAINLESS TROWEL 360 X 130 MM



No.	specification	
31151	straight	10



FESTA

STAINLESS TROWEL 360 X 130 MM



No.	specification	
31150	straight	10



FESTA

STAINLESS TROWEL 480 X 130 MM



No.	specification	
31082	straight	10



FESTA

STAINLESS TROWEL 680 X 130 MM



No.	specification	
31155	straight	10

**FESTA**

STAINLESS TROWEL 500 X 130 MM

INOX

No.	specification	
31081	straight	10

**FESTA**

NOTCHED STAINLESS TROWEL 500 X 130 MM

INOX

No.	specification	
31052	e 4	10
31061	e 6	10
31062	e 8	10
31071	e 10	10
31072	e 12	10

**FESTA**

STAINLESS STEEL TROWEL

· rubber handle

INOX

No.	specification		No.	rozméry	
31232	120 mm	10	31234	160 mm	10
31233	140 mm	10	31235	180 mm	10

**FESTA**

STAINLESS STEEL TROWEL

INOX

No.	specification		No.	specification	
31220	120 x 80 mm	10	31222	160 x 115 mm	10
31221	140 x 80 mm	10	31231	180 x 120 mm	10

**FESTA**

STAINLESS STEEL TROWEL

· rubber handle

INOX

No.	specification	
31334	160 x 100 mm	10

**FESTA**

STAINLESS STEEL TROWEL

INOX

No.	specification	
31343	160 x 100 mm	10

**FESTA**

STAINLESS STEEL TROWEL

· rubber handle

INOX

No.	specification		No.	specification	
31360	40 mm	10	31400	100 mm	10
31380	60 mm	10	31403	120 mm	10
31390	80 mm	10			

**FESTA**

STAINLESS STEEL TROWEL

INOX

No.	specification		No.	specification	
31362	40 mm	10	31392	80 mm	10
31382	60 mm	10	31402	100 mm	10
			31404	120 mm	10



FESTA

CAT TONGUE STAINLESS STEEL TROWEL

· rubber handle

INOX

No.	specification	
31330	140 x 50 mm	10
31340	160 x 60 mm	10



FESTA

CAT TONGUE STAINLESS STEEL TROWEL

INOX

No.	specification	
31332	140 x 50 mm	10
31341	160 x 60 mm	10



FESTA

STAINLESS STEEL TROWEL FOR INNER CORNER

· rubber handle

INOX

No.	specification	
31280	80 x 60 x 60 mm	10



FESTA

STAINLESS STEEL TROWEL FOR INNER CORNER

INOX

No.	specification	
31281	80 x 60 x 60 mm	10



FESTA

STAINLESS STEEL TROWEL FOR OUTER CORNER

· rubber handle

INOX

No.	specification	
31270	80 x 60 x 60 mm	10



FESTA

STAINLESS STEEL TROWEL FOR OUTER CORNER

INOX

No.	specification	
31271	80 x 60 x 60 mm	10



FESTA

STAINLESS STEEL TROWEL

· rubber handle

INOX

No.	specification	
31320	140 x 75 mm	10



FESTA

STAINLESS STEEL TROWEL

INOX

No.	specification	
31322	140 x 75 mm	10

**FESTA**

NOTCHED STAINLESS STEEL TROWEL

INOX

No.	specification	
31218	180 mm e 6	12

**FESTA**

STAINLESS STEEL PUTTY KNIFE

· rubber handle

INOX

No.	specification		No.	specification	
31510	40 mm	10	31513	100 mm	10
31511	60 mm	10	31514	120 mm	10
31512	80 mm	10	31515	140 mm	10

**FESTA**

STAINLESS STEEL PUTTY KNIFE

INOX

No.	specification		No.	specification	
31461	40 mm	12	31491	100 mm	12
31471	60 mm	12	31467	120 mm	12
31481	80 mm	12	31468	140 mm	12

**FESTA**

STAINLESS STEEL SCRAPER

· rubber handle
· thick blade

INOX

No.	specification	
32173	75 mm	10

**FESTA**

STAINLESS STEEL SCRAPER

· recommended pole handle 52010
· thick blade

INOX

No.	specification	
32170	100 mm	12

**FESTA**

STAINLESS STEEL PUTTY KNIFE WITH BIT

· rubber handle

INOX

No.	specification	
31455	150 mm	12
31456	200 mm	12

**FESTA**

STAINLESS STEEL PUTTY KNIFE

· rubber handle

INOX

No.	specification	
31505	200 mm	5
31506	250 mm	5
31507	300 mm	5



FESTA

STAINLESS STEEL PUTTY KNIFE

INOX

No.	specification	
31555	35 cm	1
31556	45 cm	1
31557	60 cm	1

No.	specification	
31558	80 cm	1
31559	100 cm	1



FESTA

STAINLESS STEEL
PUTTY KNIFE HOLDER

· for 31555 - 31559
· handle 52010, 52011, 52012, 52020, 52030

No.	Specification	
31610		1



FESTA

TELESCOPIC HANDLE

· thread for 31610, 34203

No.	Specification	
52011	88 - 140 cm	1



31523 handle 61254

31524

STAINLESS STEEL SPATULAS WITH REINFORCEMENT

INOX

MADE IN EU



No.	specification	
31520	400 mm	1
31521	500 mm	
31522	600 mm	

STAINLESS STEEL SPATULAS WITH REINFORCEMENT ACCESSORIES

MADE IN EU



No.	specification	
31523	ALU holder	1
31524	plastic holder	1



FESTA

FACADE STAINLESS STEEL PUTTY KNIFE

INOX

No.	specification	
31552	400 mm	10
31553	600 mm	10

STAINLESS STEEL PUTTY KNIFE

INOX

MADE IN EU

No.	specification	
31541	250 mm	1
31551	250 mm narrow	1



FESTA

STAINLESS STEEL PUTTY KNIFE

INOX

No.	specification	
31498	150 mm	12
31499	200 mm	12
31500	100 mm	12

STAINLESS STEEL PUTTY KNIFE

INOX

MADE IN EU

No.	specification	
31493	40 mm	20
31494	60 mm	20
31495	80 mm	20
31496	100 mm	20



FESTA

PUTTY KNIFE

No.	specification	
32161	30 mm	10
32162	40 mm	10
32163	50 mm	10
32164	60 mm	10
32169	70 mm	10
32165	80 mm	10



FESTA

STAINLESS STEEL SCRAPER

· thick blade

INOX

No.	width	length	
32174	100 mm	500 mm	1



PUTTY KNIFE

No.	specification	
32176	30 mm	12
32186	40 mm	12
32196	50 mm	12
32206	60 mm	12



SET OF PUTTY KNIVES

3x

No.	specification	
32240	30, 50, 80 mm	10





STEEL TROWEL

No.	specification	
32062	280 x 160 mm	10
32076	400 x 100 mm	36
32060	500 x 140 mm	5



STEEL TROWEL

No.	specification	
32064	500 x 90 mm	5
32066	550 x 140 mm	5



PLASTERERS TROWEL

No.	specification	
32015	160 x 130 mm	10
32014	180 x 130 mm	10
32016	200 x 140 mm	10



PLASTERERS TROWEL

No.	specification	
32001	160 x 110 mm	10
32002	160 x 130 mm	10
32003	180 x 130 mm	10
32013	200 x 140 mm	10



PLASTERERS TROWEL

No.	specification	
32018	160 x 110 mm	10



PLASTERERS TROWEL

No.	specification	
32024	140 x 80 mm	12



CAT TONGUE TROWEL

No.	specification	
32020	140 x 65 mm	12
32021	140 x 40 mm	12



PLASTERERS TROWEL

No.	specification	
32026	140 x 85 mm	12



FESTA

DIPPER STAINLESS STEEL

INOX

No.	specification	
32285	Ø 180 mm	1



FESTA

DIPPER ZN COATED

Zn

No.	specification	
32265	Ø 180 mm	10



FESTA

DIPPER

No.	specification	
32273	Ø 160 mm	10
32283	Ø 180 mm	10
32293	Ø 215 mm	10



DIPPER PLASTIC



No.	specification	
32270	Ø 160 mm	1



DIPPER

· recommended pole handle 61215

No.	specification	
32302	Ø 180 mm	1
32313	Ø 215 mm	1
32301	Ø 235 mm	1



DIPPER FOR SHOVEL BUTT

· recommended pole handle 61200, 61201

No.	specification	
32268	Ø 215 mm	1
32269	Ø 235 mm	1
32296	Ø 215 mm	1



DIPPER WITH BUTT

MOQ
3

No.	specification	
32295	Ø 180 mm length of butt 160 cm	3
32297	Ø 215 mm length of butt 160 cm	3
32298	Ø 235 mm length of butt 160 cm	3



CONCRETE MIXER

No.	specification	
60100	concrete mixer 295 x 150 mm	24
61169	concrete mixer with butt 160 cm	3
61218	butt 160 cm	5

**FESTA**

STAINLESS STEEL PAINT SCRAPER

INOX

No.	specification	
31497	63 x 195 mm	12

**FESTA**

STAINLESS STEEL WALLPAPER KNIFE

INOX

No.	specification	
31503	150 mm	12



PAINT SCRAPER

MADE IN EU

No.	specification	
31501	100 mm	30
31502	spare edge	1



DRYWALL PLASTIC PUTTY KNIFE

PLASTIC

No.	specification	
34308	50 mm	20
34307	80 mm	12
34306	100 mm	10
34305	150 mm	12

**FESTA**

SET OF PUTTY KNIVES

4x

No.	specification	
31452	stainless 50, 80, 100, 120 mm	10
31453	metal 50, 80, 100, 120 mm	10

**FESTA**

SET OF PUTTY KNIVES, PLASTIC

PLASTIC 4x

No.	specification	
31454	50, 80, 100, 120 mm	12



PUTTY KNIFE

No.	specification	
31601	180 mm - straight	1
31602	180mm A1	1
31603	180mm A2	1
31641	180 mm - e4	1



PUTTY KNIFE

No.	specification	
31651	250 mm - straight	1
31655	250 mm - e4	1



DENTED SPREADER WITH TEETH

No.	specification	
37101	150 x 80 mm	100
37111	170 x 115 mm	100



DENTED SPREADER

No.	specification	
37051	rovná	1
37031	zub - 4 x 6 mm	1
37041	zub - 6 x 6 mm	1



PLASTERERS TROWEL

No.	specification	
32022	140 x 80 mm	12
32023	125 x 40 mm	12

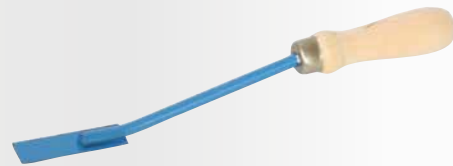

JOINT TROWEL ONE-SIDED

No.	specification	
32040	10 mm	20
32041	12 mm	20
32042	15 mm	20
32043	18 mm	20
32044	20 mm	20



JOINT TROWEL DOUBLE-SIDED

No.	specification	
32050	10 12 mm	50
32051	10 15 mm	50
32052	10 18 mm	50
32053	15 20 mm	50



BUILDING CARVER FOR AERATED CONCRETE

No.	specification	
32037	600 mm	1

**FESTA**

BAR TROWEL FOR AERATED CONCRETE

· poplar

MOQ
2

No.	specification
32317	450 x 95 mm



2

**FESTA**

FINE BAR TROWEL FOR AERATED CONCRETE

· poplar

MOQ
2

No.	specification
32312	450 x 95 mm



2

**FESTA**

BAR TROWEL FOR AERATED CONCRETE

· poplar

MOQ
2

No.	specification
32337	260 x 95 mm



2

**FESTA**

FINE BAR TROWEL FOR AERATED CONCRETE

· poplar

MOQ
2

No.	specification
32338	260 x 95 mm



2

**FESTA**

BAR TROWEL FOR BRISOLITE

· poplar

MOQ
2

No.	specification
32327	230 x 145 mm



2

NEW

BAR TROWEL FOR AERATED CONCRETE

MOQ
2

No.	Specification
32332	450 x 95 mm



2

NEW

BAR TROWEL FOR BRISOLITE

MOQ
2

No.	Specification
32333	230 x 145 mm



2



FESTA
BAR TROWEL



MOQ
2

No.	specification	
32314	400 x 180 mm	2



FESTA
BAR TROWEL



MOQ
2

No.	specification	
32329	270 x 130 mm	2



FESTA
BAR TROWEL WITH HOLES



MOQ
2

No.	specification	
33168	380 x 160 mm	2

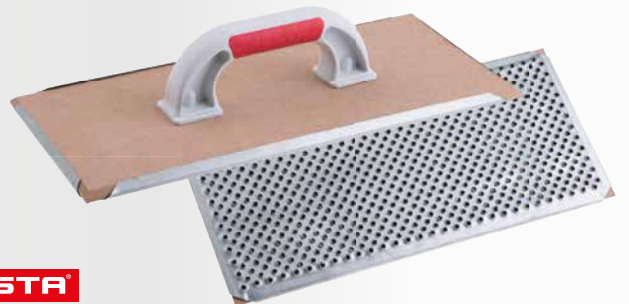

FESTA
BAR TROWEL



MOQ
2

No.	specification	
32320	400 x 180 mm	2



FESTA
BAR TROWEL



MOQ
2

No.	Specification	
32311	400 x 180 mm	2



FESTA
SANDING TROWEL



MOQ
2

No.	specification	
32418	400 x 180 mm asperity 16	2
32421	400 x 180 mm asperity 16 sanding paper	10



FESTA
SANDING TROWEL



MOQ
2

No.	specification	
32318	400 x 180 mm	2
32319	500 x 250 mm	2
32321	400 x 180 mm asperity 16 sanding paper	10
32322	500 x 250 mm asperity 16 sanding paper	10



FESTA
SANDING TROWEL PLASTIC



MOQ
2

No.	specification	
32324	270 x 130 mm asperity 16	2
32323	270 x 130 mm asperity 16 sanding paper	10

**FESTA**

SANDING TROWEL

MADE IN
EUMOQ
2

No.	specification	
32330	400 x 180 mm	2
32331	270 x 130 mm	2

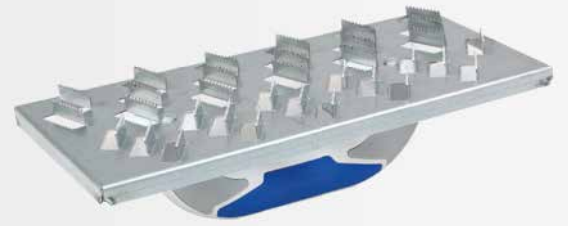

BAR TROWEL

Zn
MADE IN
EUMOQ
2

No.	specification	
32328	285 x 145 mm	10

**FESTA**

BAR TROWEL

MADE IN
EUMOQ
2

No.	specification	
32325	225 x 105 mm	2

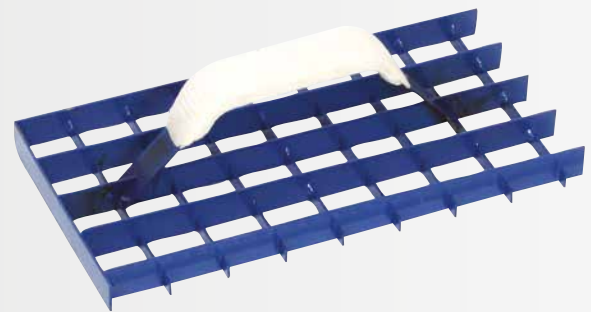

GRILL BAR TROWEL

MOQ
2

No.	specification	
32316	280 x 150 mm	20

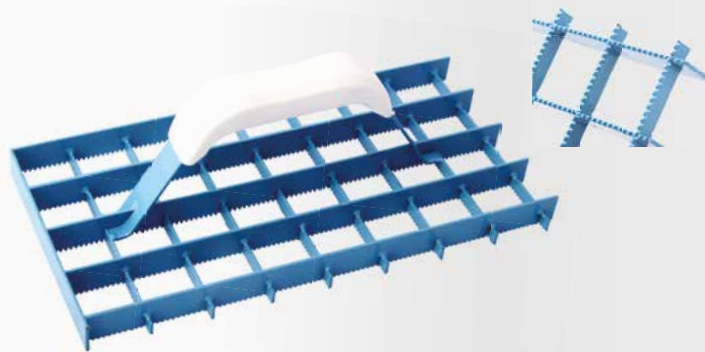

GRILL BAR TROWEL NOTCHED

MOQ
2

No.	specification	
32335	290 x 145 mm	2



GRILL BAR TROWEL

· 8 edges

ALU

MOQ
2

No.	specification	
32326	450 x 90 mm	20



BAR TROWEL PLASTIC

· 6 edges

MOQ
2

No.	specification	
32315	270 x 90 mm	30



TROWEL PLASTIC

MADE IN
EU

No.	specification	
34028	400 x 180 mm	20



FESTA
TROWEL PLASTIC



No.	specification	
34027	400 x 180 mm	20



FESTA
FLOAT PLASTIC



No.	specification	
30003	270 x 125 mm	28
30004	235 x 115 mm	35
30005	210 x 115 mm	38
30007	210 x 60 mm	44



FESTA
WOODEN TROWEL

· linden wood



No.	specification	
34005	400 x 145 mm	40
34007	290 x 145 mm	20



WOODEN TROWEL

· poplar wood



No.	specification	
34006	400 x 145 mm	40

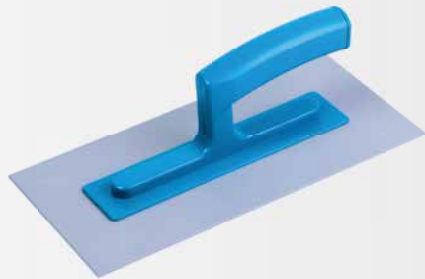

FESTA
TROWEL ABS



No.	specification	
34041	280 x 140 - 2 mm	10
34051	280 x 140 - 3 mm	10
34053	280 x 140 - 3 mm teeth - e6	10



MASON STAFF



No.	specification	
15889	980 x 380 mm butt Ø 32 mm	1



MASON STAFF - RUBBER

No.	specification	
15886	450 mm butt Ø 23 mm	48
15887	600 mm butt Ø 23 mm	48
15888	750 mm butt Ø 23 mm	32



MASON STAFF



No.	specification	
15885	100 x 800 mm butt Ø 32 mm	1

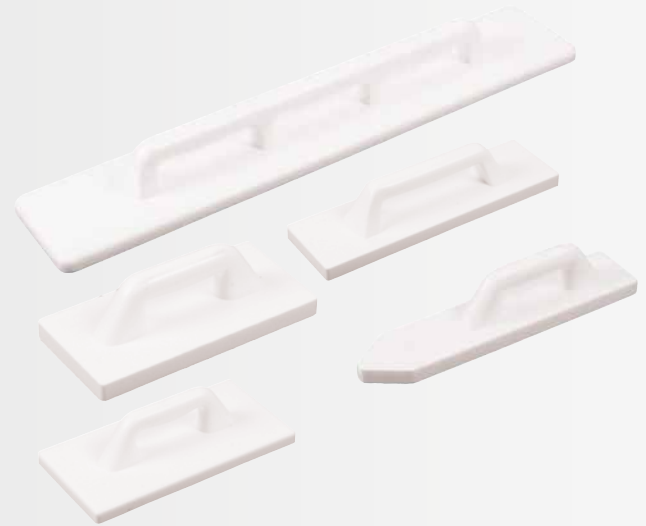

POLYURETHAN FLOAT



No.	specification	
34122	120 x 240 mm	50
34132	140 x 280 mm	40
34142	180 x 320 mm	25
34152	200 x 360 mm	20
34121	80 x 260 mm chamfered	50
34153	100 x 400 mm	30

No.	specification	
34154	220 x 420 mm	15
34155	240 x 480 mm	15
34156	280 x 500 mm	10
34157	330 x 330 mm	5
34158	120 x 800 mm	5
34159	120 x 1000 mm	5
34160	120 x 1200 mm	5

POLYSTYREN FLOAT



No.	specification	
34101	80 x 350 mm chamfered	10
34061	130 x 270 mm	10
34111	170 x 320 mm	10
34071	130 x 450 mm	10
34081	140 x 750 mm	10
34091	140 x 900 mm	5



POLYURETHAN FLOAT



No.	specification	
34115	140 x 280 mm	36
34116	180 x 320 mm	36
34117	200 x 360 mm	24
34118	220 x 420 mm	24



SANDING MASH HOLDER

No.	specification	
34301	230 x 105 mm	1
34304	235 x 80 mm	1



FESTA

SANDING MASH HOLDER

No.	specification	
34200	210 x 115 mm	30
34201	240 x 105 mm	50
34202	240 x 80 mm	50



SANDING MASH HOLDER

· handle 52030

ALU

No.	specification	
34203	230 x 80 mm aluminium	1
52030	telescopic pole	12

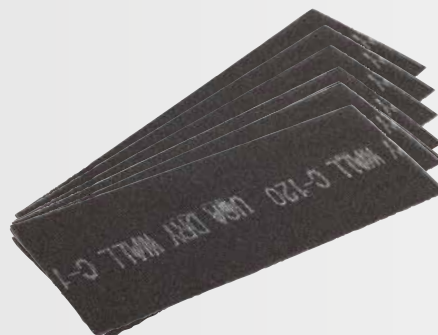

SANDING MESH SET

10x

No.	specification	
34271	115 x 290 mm zrn. 120	80
34272	115 x 290 mm zrn. 100	80
34273	115 x 290 mm zrn. 80	80
34274	93 x 290 mm zrn. 120	80
34275	93 x 290 mm zrn. 100	80
34276	93 x 290 mm zrn. 80	80

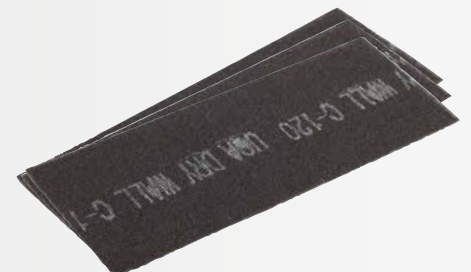

SANDING MESH SET

3x

No.	specification	
34280	115 x 290 mm zrn. 120	20
34281	115 x 290 mm zrn. 100	20
34282	115 x 290 mm zrn. 80	20
34283	93 x 290 mm zrn. 120	20
34284	93 x 290 mm zrn. 100	20
34285	93 x 290 mm zrn. 80	20

MATERIAL SURFACE	CONCRETE		PLASTER			STICK AND JOINTING MATERIAL	FACADE STICK	APPLICATION
	ROUGH	SCREEDING	CORE	SOFT INWARD	SOFT YONG			
BLACK FELT (BROWN, GREY)				••••		••		grading of the soft plaster, using for the bigger corn of the plaster
WHITE FELT				••••	••••	••••		grading of the soft plaster, using for the smaller corn of the plaster
SOFT FOAM				••••	••••	••••		elimination of the free sand, for the soft stucco
ROUNG FOAM				••••	••••	••••		elimination of the free sand, for the rough stucco
RASTER FOAM				••••	••••	••••		elimination of the free sand, thanpcs to the raster gives better capture of the rough stucco
SEA SPONGE					•••		••••	washing of the jointing material, for the thin joint, elimination of the sand
HYDRO SPONGE SOFT, ROUNG					•		••••	washing of the jointing material, for the thick joint, elimination of the sand
SPONGE				••	••••	••	••••	washing of the jointing material, assurance of the soft plaster
MICRO RUBBER							••••	crowd the jointing material to the joint
RUBBER FOAM							••••	crowd the jointing material to the joint
MIRELON		••••	•••					process with the concrete, defray of the core
DUREN				••••	••	••••		match of the soft plaster
WOOD	••••	••••	••••					process with the concrete, defray of the core
STEEL PLATE	••	••••		••		••••	••	smoothing of the concrete, inaccessible places
POLYSTYRENE	•••	••••	•••	••		••		process with the concrete, defray of the core
POLYURETHAN	••••	••••	••••					process with the concrete, defray of the core
ABS		••		••••	••••	••••	••••	combed and twisted stucco, spreading of the soft plaster, scuntion
STAINLESS SMOOTH				••••	••••	••••	••••	spreading of the soft plaster, spreading of the facade stick
STAINLESS TOOTHED							••••	spreading of the stick for facings and pavings
GRINDING FLOAT FOR POLYSTYRENE, PLASTIC			••				••••	grinding of the polystyrene, grinding of the cement stick, concrete, walling, plaster
GRINDING FLOAT FOR POLYSTYRENE, POLYWOOD			••				••••	grinding of the facade polystyrene

**FESTA**

FLOAT WITH FELT

MADE IN
EU

No.	specification		No.	specification	
34400	280 x 140 x 8 mm	15	34450	220 x 130 x 8 mm	15
34415	250 x 130 x 8 mm	15	34445	220 x 70 x 8 mm	20

**FESTA**

FLOAT WITH FELT

MADE IN
EU

No.	specification		No.	specification	
34401	280 x 140 x 10 mm	15	34451	220 x 130 x 10 mm	15
34416	250 x 130 x 10 mm	15	34446	220 x 70 x 10 mm	20

**FESTA**

FLOAT WITH SPONGE

MADE IN
EU

No.	specification	
34441	280 x 140 x 12 mm	15
34440	250 x 130 x 12 mm	15

**FESTA**

FLOAT WITH SOFT SPONGE

MADE IN
EU

No.	specification		No.	specification	
34405	280 x 140 x 18 mm	15	34480	280 x 140 x 12 mm	15
34420	250 x 130 x 18 mm	15	34481	250 x 130 x 12 mm	15
34454	220 x 130 x 18 mm	15	34482	220 x 130 x 12 mm	15
34449	220 x 70 x 18 mm	20			

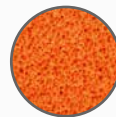
**FESTA**

FLOAT WITH EXTRA SOFT SPONGE

MADE IN
EU

No.	specification	
34443	280 x 140 x 12 mm	15
34442	250 x 130 x 12 mm	15
34439	250 x 130 x 18 mm	15

**FESTA**

FLOAT WITH SOFT MOLITAN



No.	specification		No.	specification	
34404	280 x 140 x 30 mm	10	34419	250 x 130 x 20 mm	10
34485	280 x 130 x 20 mm	10	34453	220 x 130 x 20 mm	10
34486	250 x 130 x 30 mm	10	34447	220 x 70 x 20 mm	10

**FESTA**

FLOAT WITH MOLITAN



No.	specification	
34409	280 x 140 x 30 mm	10
34425	250 x 130 x 20 mm	10

**FESTA**

FLOAT WITH MOLITAN

MADE IN
EU

No.	specification	
34410	280 x 140 x 30 mm	10
34426	250 x 130 x 20 mm	10



FESTA

FLOAT WITH SPONGE



No.	specification	
34406	280 x 140 x 30 mm	10
34421	250 x 130 x 30 mm	10
34455	220 x 130 x 30 mm	10



FESTA

FLOAT WITH SPONGE



No.	specification	
34413	280 x 140 x 30 mm	10
34428	250 x 130 x 30 mm	10



FESTA

FLOAT WITH SPONGE



No.	specification	
34412	280 x 140 x 30 mm	10
34424	250 x 130 x 30 mm	10
34458	220 x 130 x 30 mm	10



FESTA

FLOAT WITH SPONGE



No.	specification	
34490	280 x 140 x 30 mm	10
34491	250 x 130 x 30 mm	10



FESTA

FLOAT WITH SPONGE



No.	specification	
34411	280 x 140 x 30 mm	10
34423	250 x 130 x 30 mm	10
34457	220 x 130 x 30 mm	10



FESTA

FLOAT WITH RUBBER

No.	specification	
34402	280 x 140 x 10 mm	15
34417	250 x 130 x 10 mm	15
34452	220 x 130 x 10 mm	15



FESTA

FLOAT WITH MICRORUBBER

No.	specification	
34403	280 x 140 x 8 mm	15
34418	250 x 130 x 8 mm	15
34496	220 x 130 x 8 mm	15



FESTA

FLOAT WITH DUREN

No.	specification	
34407	280 x 140 x 20 mm	10
34422	250 x 130 x 20 mm	10
34456	220 x 130 x 20 mm	10
34448	220 x 70 x 20 mm	10



FESTA
FLOAT WITH RUVEN



No.	specification	
34414	280 x 140 x 20 mm	10
34429	250 x 130 x 20 mm	10
34459	220 x 130 x 20 mm	10
34479	220 x 70 x 20 mm	10



FESTA
FLOAT PLASTIC

No.	specification	
30003	270 x 125 mm	28
30004	235 x 115 mm	35
30005	210 x 115 mm	38
30007	210 x 60 mm	44

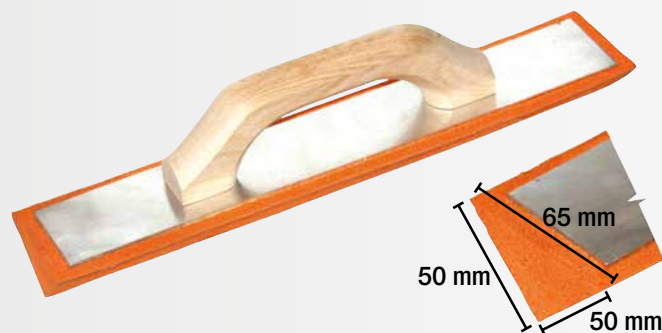
FESTA
FLOAT

No.	specification	
34033	240 x 95 mm	5

FLOAT WITH SPONGE 90°

No.	specification	
34500	350 mm	6

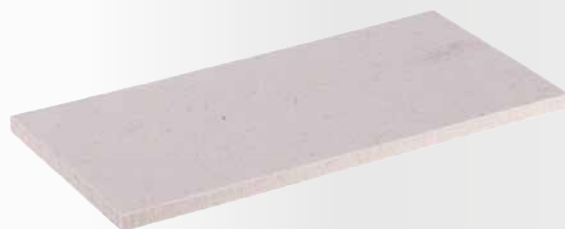

REPLACEMENT FELT

No.	specification	
34241	280 x 140 x 8 mm	1
34223	250 x 130 x 8 mm	1



REPLACEMENT FELT

No.	specification	
34243	280 x 140 x 10 mm	1
34221	250 x 130 x 10 mm	1

REPLACEMENT SOFT SPONGE

No.	specification	
34262	280 x 140 x 18 mm	1

REPLACEMENT SOFT MOLITAN

No.	specification	
34251	280 x 140 x 30 mm	1



REPLACEMENT MOLITAN



No.	specification	
34261	280 x 140 x 30 mm	1

REPLACEMENT SPONGE



No.	specification	
34265	280 x 140 x 30 mm	1



REPLACEMENT SPONGE



No.	specification	
34238	280 x 140 x 30 mm	1

REPLACEMENT SPONGE



No.	specification	
34237	280 x 140 x 30 mm	1
34235	250 x 130 x 30 mm	1



REPLACEMENT RUBBER



No.	specification	
34231	280 x 140 x 10 mm	1

FESTA**ELECTRIC MIXER FOR BUILDING MIXTURES**

Input	1800 W
Voltage / frequency	230 V / 50 Hz
Gears	2
1st gear (idle speed)	0 - 450 ot./min.
2nd gear (idle speed)	0 - 790 ot./min.
Overload protection	Yes
Mixing basket diameter	100 mm
Broom length	570 mm
Weight	5,6 kg



No.	specification	
35311	stirrer	1
35318	spare carbon	1
35319	spare stirrers - pair (L + R)	1

**FESTA****ELECTRIC MIXER 850W**

Power input	850 W
Voltage	230 V / 50 Hz
Number of gears	1
No-Load-speed	0 - 500 ot./min.
No-Load-speed	-
Protection	Yes
Thread	M 14
Mixing paddle	120 mm
Length of mixing paddle	600 mm
Weight	3,7 kg

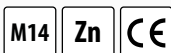

No.	specification	
35300		1
35316	spare carbon	1

**FESTA****ELECTRIC MIXER 1600 W**

Power input	1600 W
Voltage	230 V / 50 Hz
Number of gears	2
No-Load-speed	0 - 480 ot./min.
No-Load-speed	0 - 800 ot./min.
Protection	Yes
Thread	M 14
Mixing paddle	140 mm
Length of mixing paddle	600 mm
Weight	4,7 kg

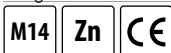

No.	specification	
35310		1
35317	spare carbon	1



FESTA

SPIRAL MIXER CLOCKWISE

Spiral mixer paddle with 3 blades and a ring – right handed – for heavy materials with a high viscosity, mortar, concrete, cement and calcareous plaster, jointing material, daub, epoxy mortar, bituminous binder. The mixing effect from below up –the paddle is taken into the material like a screw.

Zn M14



No.	specification	
35085	M14 Ø 120 x 600 mm	12
35086	M14 Ø 140 x 600 mm	12
35087	M14 Ø 160 x 600 mm	12

FESTA

SPIRAL MIXER COUNTERCLOCKWISE

Spiral mixer paddle with 3 blades and a ring – left handed – for slurry fluid mixtures in bulky amounts. The mixed material is pressed down. The slurry liquid does not splash from the bin, the settled pigmentation of paints can get up and are mixed perfectly.

Zn M14



No.	specification	
35091	M14 Ø 120 x 600 mm	12
35092	M14 Ø 140 x 600 mm	12
35093	M14 Ø 160 x 600 mm	12

FESTA

SPIRAL MIXER

Spiral mixer paddle with 2 blades - for the full mixture of the tile cement, jointing materials, sizing material, renders, screed, blinding materials, smoothing compounds.

Zn



No.	specification	
35038	Ø 80 x 500 mm	24
35058	Ø 100 x 500 mm	24
35023	Ø 120 x 500 mm	24

FESTA

SPIRAL MIXER

Spiral mixer paddle with 2 blades - for the full mixture of the tile cement, jointing materials, sizing material, renders, screed, blinding materials, smoothing compounds.

SDS+ Zn



No.	specification	
35094	Ø 80 x 500 mm	24
35095	Ø 100 x 500 mm	24
35096	Ø 120 x 500 mm	24

FESTA**SPIRAL MIXER**

Spiral mixer paddle with 2 blades - for the full mixture of the tile cement, jointing materials, sizing material, renders, screed, blinding materials, smoothing compounds.

M14 **Zn**

No.	specification
35059	M14 Ø 90 x 550 mm



24

FESTA**SPIRAL MIXER WITH LONGER SPIRAL**

Spiral mixer paddle with 2 blades - for the full mixture of the tile cement, jointing materials, sizing material, renders, screed, blinding materials, smoothing compounds.

 **Zn**

No.	specification
35013	Ø 80 x 500 mm
35006	Ø 100 x 500 mm
35007	Ø 120 x 500 mm



24

24

24

FESTA**SPIRAL MIXER WITH LONGER SPIRAL**

Spiral mixer paddle with 2 blades - for the full mixture of the tile cement, jointing materials, sizing material, renders, screed, blinding materials, smoothing compounds.

SDS+ **Zn**

No.	specification
35012	Ø 100 x 500 mm



24

FESTA**SPIRAL MIXER**

Spiral mixer paddle with 2 blades - for the full mixture of the tile cement, jointing materials, sizing material, renders, screed, blinding materials, smoothing compounds.

 **Zn**

No.	specification
35069	Ø 60 x 500 mm
35078	Ø 80 x 500 mm
35081	Ø 100 x 500 mm



50

24

24

FESTA

SPIRAL MIXER

Spiral mixer paddle with 2 blades - for the full mixture of the tile cement, jointing materials, sizing material, renders, screed, blinding materials, smoothing compounds.

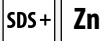

No.	specification	
35070	∅ 60 x 500 mm	50
35079	∅ 80 x 500 mm	24
35082	∅ 100 x 500 mm	24

FESTA

SPIRAL MIXER

Spiral mixer paddle with 2 blades - for the full mixture of the tile cement, jointing materials, sizing material, renders, screed, blinding materials, smoothing compounds.



No.	specification	
35048	∅ 70 x 500 mm	24
35068	∅ 90 x 500 mm	24

FESTA

SPIRAL MIXER

Appropriate for high viscose and adhesive materials, such as construction adhesives and cement, plaster, screed floor cover etc. The material flows from the button to level.



No.	specification	
35021	∅ 100 x 500 mm	24

FESTA

MIXER

Cage mixed paddle – for materials where air intake is undesirable. For fluid smoothing compounds, blinding materials, sealing material, glue.



No.	specification	
35015	∅ 100 x 500 mm	20

FESTA**PROPELLER MIXER**

Propeller mixer paddle – for fluid materials, paints, wall and dispersed glues for sticking wallpapers, tile glue.



No.	specification	
35011	Ø 80 x 500 mm	50

SPIRAL MIXER

Arcaded mixer paddle with a ring - for the full mixture of wall paints, dispersed paints, glues, flooding compounds, paints, asphalted bitumen, coatings.



No.	specification	
35125	Ø 60 x 400 mm	40
35126	Ø 80 x 400 mm	40
35127	Ø 100 x 600 mm	20

SPIRAL MIXER LACQUARED

Arcaded mixer paddle with a ring - for the full mixture of wall paints, dispersed paints, glues, flooding compounds, paints, asphalted bitumen, coatings.



No.	specification	
35103	Ø 60 x 400 mm	40
35113	Ø 80 x 400 mm	40
35123	Ø 100 x 600 mm	20

**EXTENSION CABLE WITH REEL**

- Extension cable with 25 m reel - IP20
- H05VV - F 3G 1.5mm², - Equipped with a thermal fuse
- Welding power: 1000 W max.
- Output power: 3000 W max.
- 4 grounded sockets with child lock.



No.	specification	
37760	4 socket, length 25 m, IP 20, 1,5 mm ²	2
37761	4 socket, length 50 m, IP 20, 1,5 mm ²	2

**EXTENSION CABLE**

No.	specification	
37730	max. 3680 W length 10 m, 1,5 mm ²	8
37731	max. 3680 W length 20 m, 1,5 mm ²	4



ELECTRIC HEATER

voltage	230V ~50Hz
output	3300W
current load	14.5A
set up performance	30/1650/3300W
temperature range	5-40°C
protection	IP24
specification	27 x 25.5 x 40cm
weight	4.8 kg

- fast and efficient heating of cellars, workshops, shops, party tents, greenhouses etc.
- does not consume oxygen
- safe operation, continuous power control, room thermostat, fan.
- stainless steel heating element
- possibility of summer use for ventilation without heating
- low noise
- high-quality processing, materials, robust steel construction, easy and safe handling, long service life



No.	specification
35833	3,3 kW



GAS HEATER

gas	G30-I3B/P
gas pressure	0.7bar
voltage	230V 50Hz
engine output	25W
max. gas consumption	1.11 Kg/h
max. heat output	15KW
max. volume of hot air	300m ³ /h

- fast and efficient heating during construction works, workshops
- it consumes oxygen!
- direct air heating with forced circulation - rapid heat gain
- safe operation, smooth power regulation
- thermostat and safety valve against overheating and leakage
- accessories included - controller and inlet gas hose
- high-quality processing, materials, robust steel construction, easy and safe handling with a long service life



No.	specification
35845	15 kW



GAS HEATER

gas	g30-i3b/p
gas pressure	1.5bar
voltage	230v 50hz
engine output	70w
max. gas consumption	2.2kg/h
max. heat output	30kw
max. volume of hot air	750m ³ /h

- fast and efficient heating during construction works, workshops
- it consumes oxygen!
- direct air heating with forced circulation - rapid heat gain
- safe operation, smooth power regulation
- thermostat and safety valve against overheating and leakage
- accessories included - controller and inlet gas hose
- high-quality processing, materials, robust steel construction, easy and safe handling with a long service life



No.	specification
35850	30 kW





PROFESSIONAL BUILDING MIXERS

Lescha

Building mixers for demanding professional use
 Gear wreath made of cast iron with patented fastening
 Double bearing seats on the drum
 Patented protection insulation, quality protection according to DIN EN ISO 9001
 Adjustable clearance teeth
 High quality finish
 Specially designed shape drum
 Protection splash-proof IP 45
 Supplied in 230V and 400V



Lescha

BUILDING MIXER



No.	specification	
35500	Star 150 - 125 l, 230 V footbrake	1



Lescha

BUILDING MIXER



No.	specification	
35502	EUROMIX 125 l, 230 V	1
35503	EUROMIX 125 l, 400 V	1



Lescha

BUILDING MIXER



No.	specification	
35501	BX 135 - 125 l, 230 V	1



Lescha

BUILDING MIXER



No.	specification	
35504	ABM 135 l, 230 V footbrake	1



Lescha

BUILDING MIXER



No.	specification	
35505	SM 145 S - 140 l, 230 V	1
35506	SM 145 S - 140 l, 400 V	1
35507	SM 145 S - 140 l, 230 V footbrake	1
35508	SM 145 S - 140 l, 400 V footbrake	1



Lescha

BUILDING MIXER



No.	specification	
35510	SM 165 S - 160 l, 230 V footbrake	1
35511	SM 165 S - 160 l, 400 V footbrake	1
35512	SM 165 S - 160 l, G petrol	1





Lescha
BUILDING MIXER



No.	specification	
35514	SM 185 S - 180 l, 230 V footbrake	1
35515	SM 185 S - 180 l, 400 V footbrake	1

Lescha
BUILDING MIXER



No.	specification	
35516	S 180 HR - 180 l, 230 V footbrake	1
35517	S 180 HR - 180 l, 400 V footbrake	1



Lescha
BUILDING MIXER



No.	specification	
35524	LB 354 230 V 1,5 kW	1
35525	LB 354 400 V 1,5 kW	1
35527	LB 354 Honda G200	1
35532	LB 404 230 V, 1,5 kW	1
35533	LB 404 400 V, 1,5 kW	1
35539	LB 484 Robin EH17B	1
35540	LB 484 Honda GX160LX	1
35542	AT 480 400 V, 1,2 kW	1



Lescha
BUILDING MIXER



No.	specification	
35552	LHB 1000 400 V	1
35553	LHB 1000 HATZ Diesel	1
35555	LHB 1200 400 V	1



Lescha
BUILDING MIXER



No.	specification	
35518	S 230 HR - 230 l, 230 V footbrake	1
35519	S 230 HR - 230 l, 400 V footbrake	1

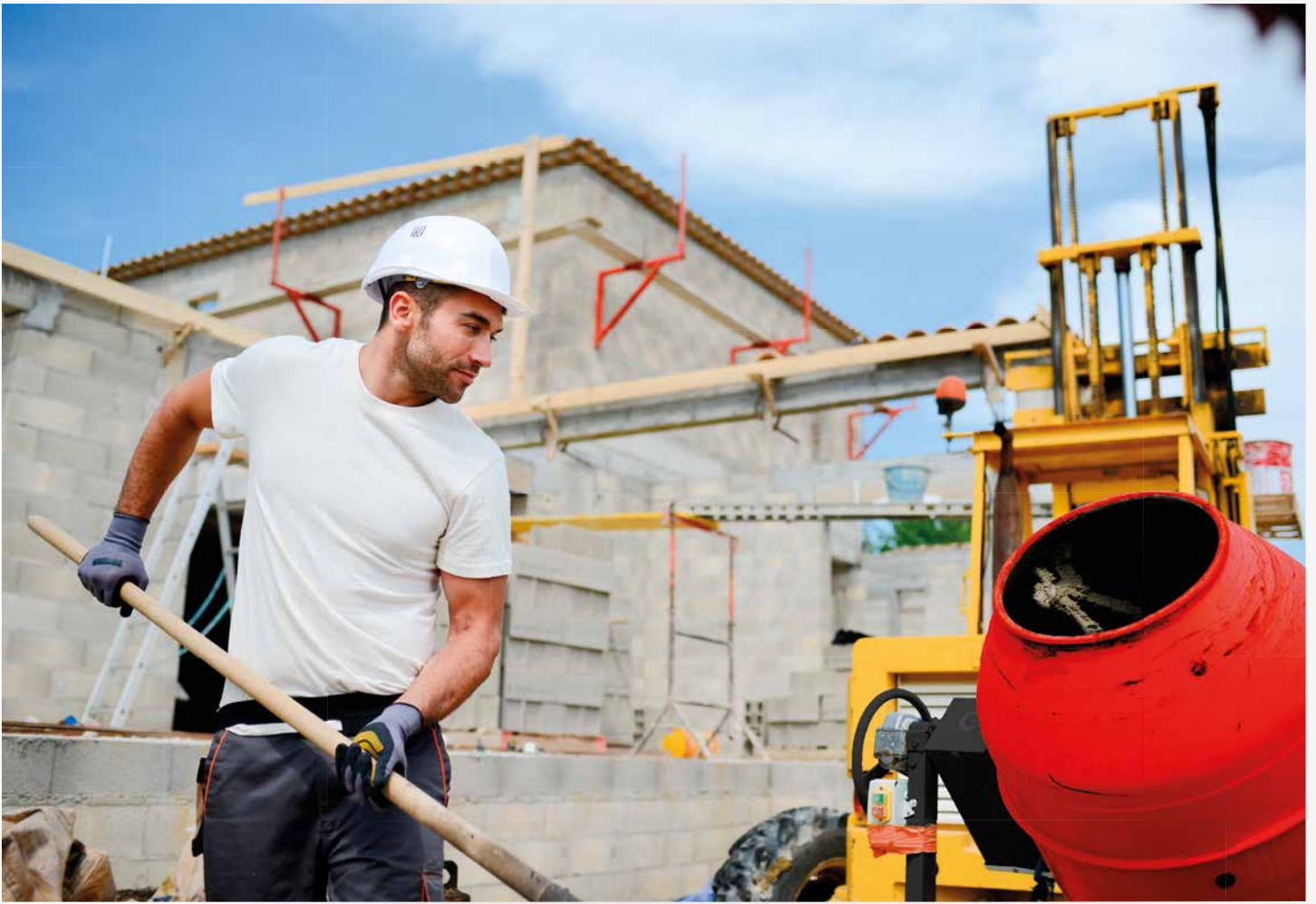

130 L

specification

volume of drum	130 l
drum speed	26±Min ⁻¹
power	700 W
voltage	230 V / 50 Hz
degree of protection	IP44
material of chaplet	litinový cast iron
specification	length 1170 mm
	width 650 mm
	high/ high 1280 mm
weight	53 kg

165 L

specification

volume of drum	165 l
drum speed	23±Min ⁻¹
power	900 W
voltage	230 V / 50 Hz
degree of protection	IP44
material of chaplet	litinový cast iron
specification	length 1295 mm
	width 735 mm
	high/ high 1440 mm
weight	70 kg



BUILDING MIXER



No.	specification			
37500	MIX 130Zk	230 V	unassembled	1
37501	MIX 130Z	230 V	assembled	1
37505	MK 165Bk	230 V	unassembled	1
37506	MK 165B	230 V	assembled	1

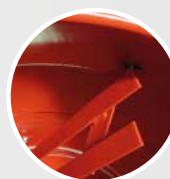

• specially made shoulder-blade 4 mm



• good quality thrust bearing



• switch with safety shield



• plastic shield of drive, cast iron wreath

BUILDING MIXER



125 L

specification	
volume of drum	125 l
drum speed	26±Min ⁻¹
power	550 W
voltage	230 V / 50 Hz
degree of protection	IP44
material of chaplet	litinový cast iron
specification	length 1102 mm width 690 mm high/ high 1310 mm
weight	52,5 kg

No.	specification		
37509	126 l, 230 V	assembled	1
37510	126 l, 230 V	unassembled	1

162 L

specification	
volume of drum	162 l
drum speed	26±Min ⁻¹
power	650 W
voltage	230 V / 50 Hz
degree of protection	IP44
material of chaplet	litinový cast iron
specification	length 1180 mm width 710 mm high/ high 1310 mm
weight	56 kg

No.	specification		
37515	162 l, 230 V	unassembled	1
37516	162 l, 230 V	assembled	1

142 L

specification	
volume of drum	142 l
drum speed	26±Min ⁻¹
power	650 W
voltage	230 V / 50 Hz
degree of protection	IP44
material of chaplet	litinový cast iron
specification	length 1164 mm width 690 mm high/ high 1293 mm
weight	54 kg

No.	specification		
37511	142 l, 230 V	unassembled	1
37512	142 l, 230 V	assembled	1

180 L

specification	
volume of drum	180 l
drum speed	26±Min ⁻¹
power	850 W
voltage	230 V / 50 Hz
degree of protection	IP44
material of chaplet	litinový cast iron
specification	length 1164 mm width 690 mm high/ high 1368 mm
weight	58 kg

No.	specification		
37517	180 l, 230 V	unassembled	1
37518	180 l, 230 V	assembled	1

**Lescha****CONSTRUCTION DEBRIS CHUTE**

No.	specification	
35603	drop basic diameter 50/40 cm, length 108 cm PE (HDPE)	1
35604	PE building debris (HDPE)	1
35605	supporting frame for hopper conformity of building rubble	1

**WHEELBARROW**

No.	specification	
37530	60 l, Ø 38 cm solid tyre	1
37532	60 l, Ø 40 cm pneumatic tyre	1

**WHEELBARROW GALVANIZED**

No.	specification	
37527	80 l, Ø 40 cm pneumatic tyre	1
37533	80 l, Ø 38 cm solid tyre	1

**WHEELBARROW HULL BLACK**

No.	specification	
37539	60 l	1

**WHEELBARROW HULL GALVANIZED**

No.	specification	
37541	80 l	1



SPARE WHEELS



No.	specification		
48729	typ AA 400	pneumatic tyre	1
48730	typ AA 380	solid tyre	1
48731	typ AA 380	solid tyre (Slovakia)	1



WHEELBARROW WITH THREE WHEELS



No.	specification		
37564	60 l		1



BRICK HOLDER

No.	specification	
36310	max. 20kg	5



CURB HOLDER

specification	60115
jaw size:	80-370 mm
max. load:	50 kg



No.	specification	
60115	For 040	1



CURB HOLDER

specification	60116
jaw size:	750-1000 mm
max. load:	120 kg



No.	specification	
60116	For 041	1



CURB HOLDER

specification	60117	60118
jaw size:	500-1000 mm	0-500 mm
max. load:	150 kg	150 kg



No.	specification	
60117	For 042	1
60118	For 043	1



STRAIGHT LINE STONE HAMMER

specification	60121	60123
height	200 mm	200 mm
width	70 kg	70 kg
length	870 mm	450 mm
weight	2,5 kg	2,2 kg



No.	specification	
60121	870 mm	1
60123	450 mm	1



PAD



No.	specification	
37166	D10 basic	25

NEW



FESTA

FOLDING SAW HORSE

· max. load: 590 kg

No. Specification

23657



1

NEW



FESTA

PORTABLE STAND VISE

· clamping range: 0 - 95 cm
· max. load: 250 kg

No. Specification

37553



1



HAND TRUCK

No.	specification	nosnost	
48719	wheel 260 mm bantam	250 kg	1

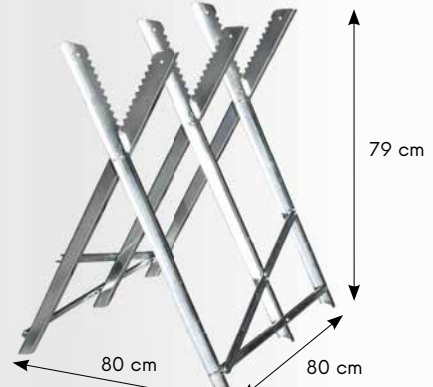

GOAT ON WOOD CUTTING

No. No.	rozměry	
37570	max. 150 kg	1

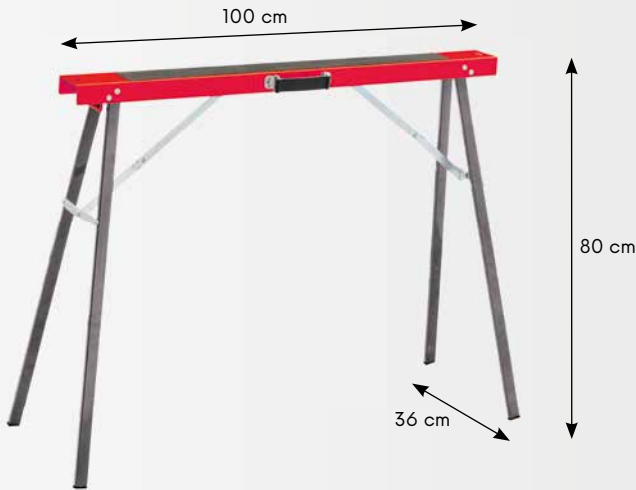

FOLDABLE SAW HORSE

• max. load capacity 125 kg

2x

No.	specification	
37549	pár	1



PLASTIC SAW HORSE

• max. load capacity 150 kg (300 kg in pair)

2x

No.	specification	
37560	pár	1



ADJUSTABLE SAW HORSE

No.	specification	
36300	68 - 130 cm, max. 125 kg	1



ADJUSTABLE SAW HORSE

No.	specification	
37545	140 cm, high 98 - 165 cm	1
37546	120 cm, high 98 - 165 cm	1

PROFESSIONAL TILE CUTTING MACHINES

- tile cutting machines for the most demanding usage
- the travel has 9 sleeved skf ball bearings
- 4 of them are adjustable and define the limits of the travel
- spring-loaded tables
- possible to assemble for working with left hand
- all spare parts and repair services are guaranteed
- the cutting wheel from chrome-wolfram steel



SUPER PRO



TILE CUTTING MACHINE SUPER FOR "EVO"

36195 spare cutting wheel - Ø 22 mm



No.	specification
36191	1250 mm



SUPER PRO



TILE CUTTING MACHINE

36195 spare cutting wheel - Ø 22 mm



No.	specification
36145	SUPER For 450 mm
36160	SUPER For 600 mm
36175	SUPER For 750 mm
36190	SUPER For 900 mm

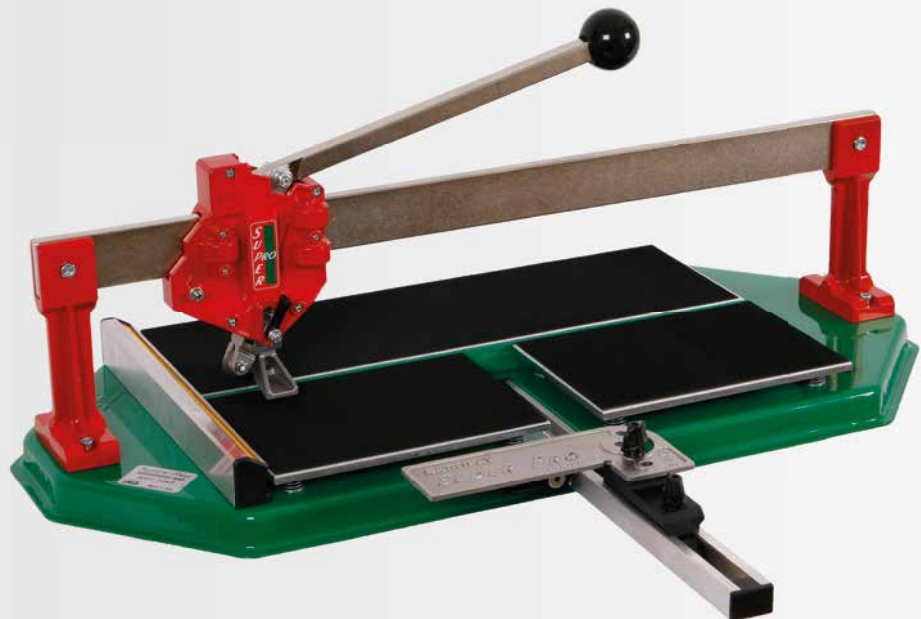



· illustrative photo

TILE CUTTING MACHINE + CASE

· 36261 spare cutting wheel - Ø 15 mm



No.	specification	
36240	400 mm	1

SUPER FOR STAND



No.	specification	
36200	sales stand	1
36199	sales stand fitted 36160, 36175, 36190	1



FESTA

TILE CUTTING MACHINE „X“

· 36138 spare cutting wheel - Ø 22 mm



No.	specification	
36085	600 mm	1
36087	900 mm	1
36086	1300 mm	1



FESTA

TILE CUTTING MACHINE

· 36195 spare cutting wheel - Ø 22 mm



No.	specification	
36080	600 mm	1
36081	750 mm	1
36082	900 mm	1
36076	750 mm assembled	1
36077	900 mm assembled	1

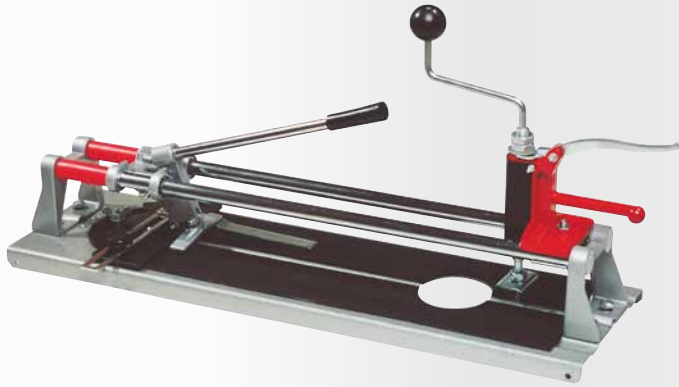

TILE CUTTING MACHINE

36128 spare cutting wheel - Ø 16 mm



No.	specification
36014	480 mm



4

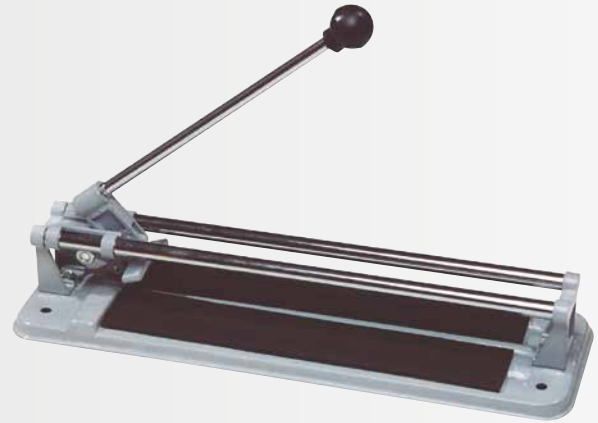

TILE CUTTING MACHINE

36126 spare cutting wheel - Ø 15 mm



No.	specification
36024	300 mm
36034	400 mm
36035	600 mm



10

10

4



TILE CUTTING MACHINE

36136 spare cutting wheel - Ø 22 mm



No.	specification
36036	480 mm



1



HAND TILE CUTTER

36136 spare cutting wheel - Ø 22,2 mm



No.	specification
36046	22 mm



1

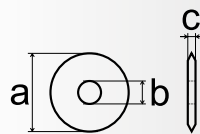

SPARE CUTTING WHEEL

No.	specification
36126	a= Ø 15 mm, b= Ø 6 mm, c= 1,5 mm
36128	a= Ø 16 mm, b= Ø 6 mm, c= 3 mm
36130	a= Ø 20 mm, b= Ø 6 mm, c= 5 mm
36136	a= Ø 22 mm, b= Ø 6 mm, c= 2 mm



1

1

1

1



JIG SAW BLADE FOR TILE CUTTING

No.	specification
24055	Karbid - BOSCH, MAKITA



1



FESTA

TILE PLIER

No.	specification
36057	200 mm



6



TILE CUTTING PLIERS

No.	specification
36056	200 mm



10



TILE PLIER

No.	specification
36059	



1



TILE PLIER

No.	specification
36058	200 mm



6



37028



37029

SPONGE 160 X 110 X 60 MM

No.	specification
37028	hydro sponge
37029	sponge cube



1



37025



37026

SPONGE 200 X 100 X 100 MM

No.	specification
37025	soft molitan cube
37026	sponge cube



1



WASH BUCKET

No.	specification
37117	set
90070	tub 25 l



1

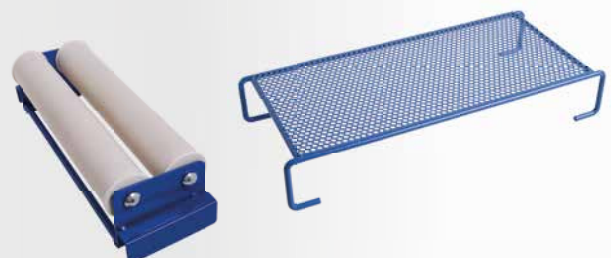

WASH BUCKET - ACCESSORIES

No.	specification
90072	grid
90071	metal rolls



1



TIPPED CLEANER

No.	specification
37012	



1



TIPPED CARBIDE CLEANER

No.	specification	
37006	30 mm	20
37007	50 mm	20
37008	spare blade 30 mm	50
37009	spare blade 50 mm	50



SET FOR APPLICATION AND REMOVING SILICONE

3x

No.	specification
16042	



12

FESTA
SQUEEGEE

No.	specification
16056	145 mm



50



DENTED SPREADER

4x

No.	specification
37053	



48



SILICON SCRAPER

No.	specification
37054	



1



SILICON SCRAPER

* for joining of windows

No.	specification
37055	



1



SQUEEGEE

No.	specification	
37011	180 mm	12
37021	280 mm	12



12

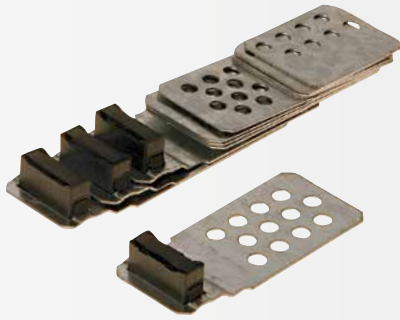

MAGNETS FOR TILES



No. 38920

1



ADJUSTABLE MAGNETS TILES



No. 38923



BUILDING CORNERS SET



No. 38919

50

NEW



FESTA

LAMINATE FLOOR CUTTER



No. 36140 specification 210 mm

4



FLOATING FLOOR INSTALLATION KIT

24x

No. 52130

1



WEDGES

50x

No.	specification	pcs	1
37210	95 x 45 x 15 - 0 mm	50	1
37211	70 x 30 x 8 - 0 mm	50	1



PUMP WEDGE

· dimension 15x17 cm
· height max. 5 cm

No. 37220

1

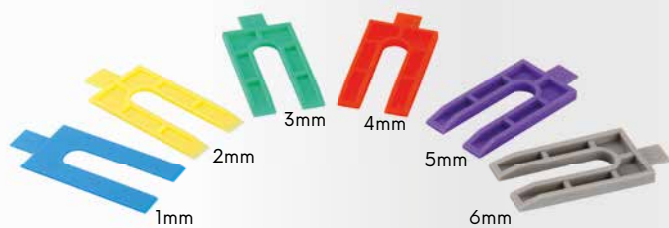

LEVELLING PADS

30x

No.	specification	pcs
37212	1 - 6 mm, 5 pcs per size	1



FESTA

WEDGES



No.	specification	pcs
37204	55 x 20 x 0 - 6 mm	20
37203	65 x 18 x 0 - 12 mm	20
37202	80 x 25 x 3 - 10 mm	20
37201	100 x 25 x 1 - 16 mm	14
37200	150 x 25 x 1 - 25 mm	8
37205	55 x 8 x 0 - 10 mm	250

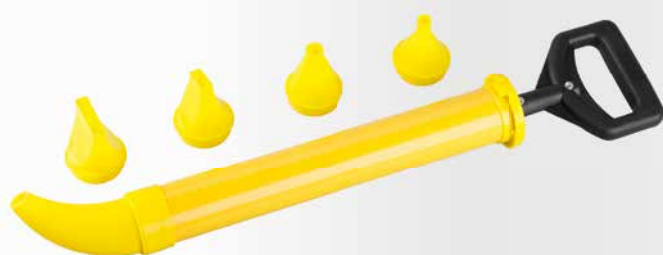

CAULKING GUN



No.	specification	pcs
38026	5x tip	1



POINTING BAG



No.	specification	pcs
38042	3x tip	1



NIVELYS PLASTIC CROSSES

reusable

100x

No.	specification	pcs
37195	1,0 mm	100
37196	1,5 mm	100
37197	2 mm	100
37198	3 mm	100



FESTA

PLASTIC CROSSES



No.	specification	pcs
37148	1,0 mm	200
37149	1,5 mm	200
37150	2 mm	200
37151	2,5 mm	200
37152	3 mm	150
37153	4 mm	100
37154	5 mm	75
37158	10 mm	30



FESTA

PLASTIC WEDGES



No.	specification	pcs
37155	0 - 8 mm	30
37156	0 - 4 mm	100
37157	2,5 - 8 mm	30

250x



No.	specification	pcs
37205	55 x 8 x 0 - 10 mm	250



FESTA

WEDGES

NEW



LEVELING CLIP SET

50x

No.	specification
37199	1,5 mm



40



NIVELYS LEVELING CLIP WITH THREAD

50x

No.	specification
37131	1 mm
37132	2 mm



40

NIVELYS LEVELING CAP WITH THREAD

• reusable

50x

No.	specification
37130	



15



NIVELYS
LEVELING SYSTEM **FESTA**

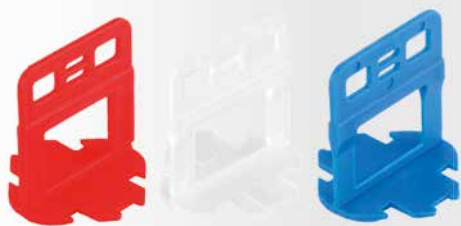

NIVELYS SPACERS

leveling wedges 37715, 37176

50x



No.	specification	pcs	krabice
37170	1 mm	50	60
37171	2 mm	50	60
37172	3 mm	50	60



NIVELYS SPACERS

100x



No.	specification	pcs	krabice
37185	1 mm	100	1
37190	1,5 mm	100	1
37186	2 mm	100	1
37187	3 mm	100	1
37188	4 mm	100	1
37189	5 mm	100	1



NEW

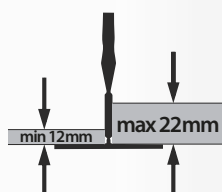

NIVELYS SPACERS

100x



No.	Specification	krabice
37162	1,5 mm	1



NIVELYS
LEVELING SYSTEM **FESTA**

NIVELYS LEVELING WEDGES

No.	pcs	krabice
37175	50	40
37176	400	3



NIVELYS SPACERS

600x



No.	specification	pcs	krabice
37125	1 mm	600	38 x 28 x 19 cm
37126	1,5 mm	600	38 x 28 x 19 cm
37127	2 mm	600	38 x 28 x 19 cm

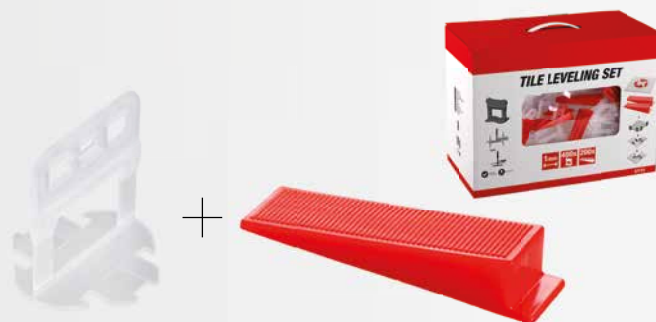

NIVELYS LEVELING SET

No.	specification	krabice
37173	1 mm, 400 pcs + 200 pcs	1
37174	1,5 mm, 400 pcs + 200 pcs	1



NIVELYS
LEVELING GUNS

No.
37177



1



NIVELYS
LEVELING GUNS

No.
37178



1

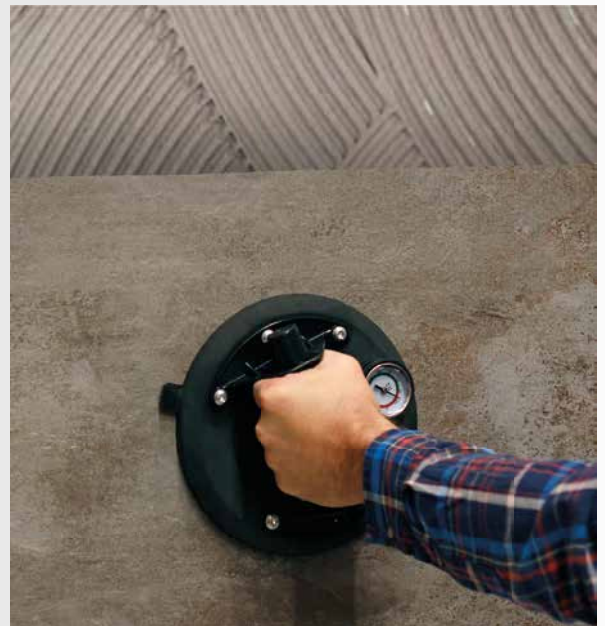

NEW



FESTA
SUCTION TILE HOLDER
WITH PRESSURE INDICATOR

· rough and structured surfaces

No. Specification
36325 max. 220 kg



1

FESTA

POWDER 180 G

No.	specification	
37096	blue	10
37094	light blue	10
37097	red	10
37095	light red	10
37098	black	10

**FESTA**

CHALK LINER 30 M + POWDER 120 G

- 6x quicker winding mechanism
- plummet line function

No.	
37070	6

**FESTA**

CHALK LINER 30 M + POWDER 150 G

- 5x quicker winding mechanism

No.	
37065	6



CHALK LINER ABS 30 M + POWDER 180 G

No.	
37069	10



CHALK LINER ABS 30 M

No.	
37067	25



CHALK LINER PLASTIC 30 M

No.	
37066	25



CHALK LINER 30 M

ALU	No.	
	37068	25



FESTA

STRING RED



No.	specification	
38895	50 m	24
38896	100 m	24

FESTA

STRING YELLOW



No.	specification	
38899	50 m	24
38900	100 m	24



FESTA

STRING POLYETHYLENE 50 M



No.	specification	
38907	red 1,0 mm	100
38908	red 1,7 mm	100
38909	red 2,0 mm	100

FESTA

STRING POLYETHYLENE 50 M



No.	specification	
38904	yellow 1,0 mm	100
38905	yellow 1,7 mm	100
38906	yellow 2,0 mm	100



FESTA

STRING POLYETHYLENE 50 M



No.	specification	
38910	orange 1,0 mm	100
38911	orange 1,7 mm	100
38912	orange 2,0 mm	100

FESTA

STRING POLYETHYLENE 50 M



No.	specification	
38901	white 1,0 mm	100
38902	white 1,7 mm	100
38903	white 2,0 mm	100

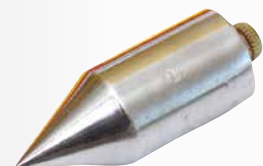

WAXED TWINE



No.	length	φ	
50920	50 m	1 mm	80

FESTA

PLUMB LINE WITH STRING 15 M



No.	specification	
38916	150 g	10
38917	300 g	6
38918	500 g	5

FESTA

PLUMB LINE



No.	specification	
38913	150 g	10
38914	300 g	10
38915	500 g	10

NEW



FESTA

POLYSTYRENE CUTTER

- voltage | frequency: 230 V/50 Hz
 - power consumption: 160 W
 - length of cut: 137 cm
 - height of cut: 30 cm
 - protection: IP44
 - angle of cut: 0° - 90°
- equipment: stand, foot switch, scaffold holder, 2x Ni-Cr cutting wire, cleaning brass brush, tools and fasteners, plastic box with wheels



No. Specification

35348



1

NEW



1,7 m

FESTA

FOOT SWITCH
FOR POLYSTYRENE CUTTER

for 35330, 35345, 35348

No. Specification

35334



1

NEW



FESTA

STAND
FOR POLYSTYRENE CUTTER

for 35330, 35345, 35348

No. Specification

35336



1

NEW



FESTA

REPLACEMENT SPRING
FOR A POLYSTYRENE CUTTER

for 35330, 35345, 35348

No. Specification

35332



1

NEW



FESTA

SCAFFOLD HOLDER
FOR POLYSTYRENE CUTTER

for 35330, 35345, 35348

No. Specification

35333



1

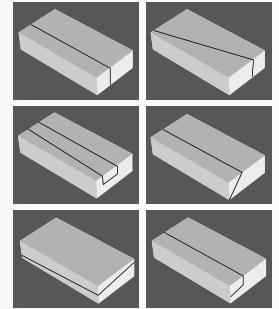
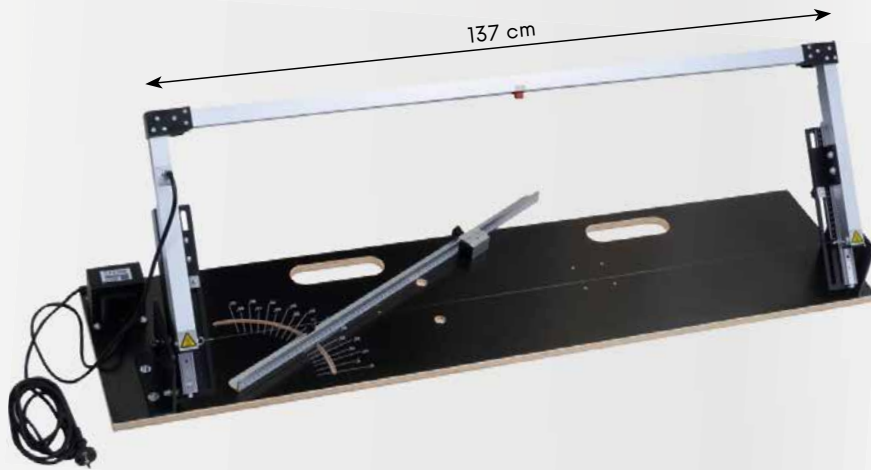

FESTA

POLYSTYRENE CUTTER

- voltage | frequency: 230 V / 50 Hz
- power consumption: 160 W
- length of cut: 137 cm
- height of cut: 30 cm
- protection: IP44
- angle of cut: 0° - 90°



• equipment: Ni-Cr cutting wire, cleaning brass brush, inbus



No.	specification	
35345	Polystyrene cutter 1500 x 450 mm	1
35346	Spare heating string Ni-Cr	1
35347	Spare power supply	1

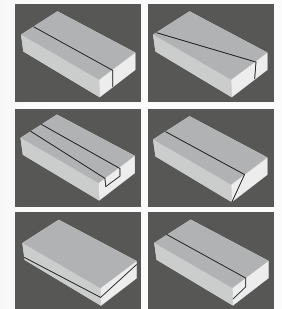
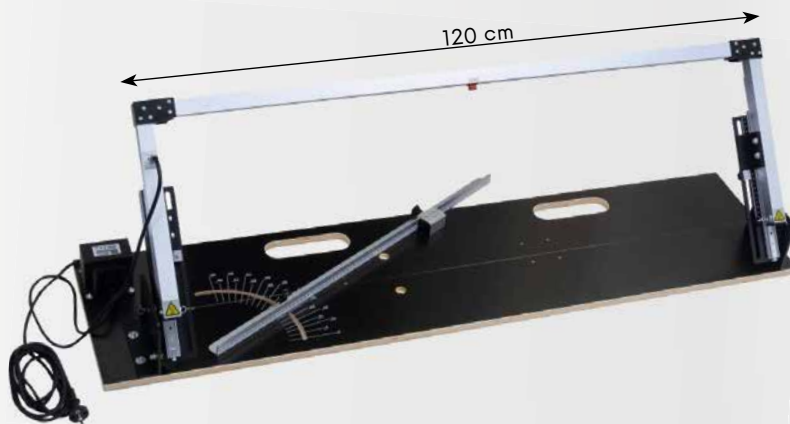

FESTA

POLYSTYRENE CUTTER

- voltage | frequency: 230 V / 50 Hz
- power consumption: 160 W
- length of cut: 120 cm
- height of cut: 30 cm
- protection: IP44
- angle of cut: 0° - 90°



• equipment: Ni-Cr cutting wire, cleaning brass brush, inbus



No.	specification	
35330	Polystyrene cutter 1350 x 450 mm	1
35331	Spare heating string Ni-Cr	1
35347	Spare power supply	1

**FESTA****CORDLESS POLYSTYRENE CUTTER**

- battery 36 V, 1,5Ah Li-ion
- power 180 W
- temperature max 350 C°
- length of knife 20 cm



· equipment: 2 pcs battery, charger, blade, cleaning brass brush, inbus

No.	specification
35323	



1

**FESTA****ELECTRIC POLYSTYRENE CUTTER**

- voltage / frequency 230 V/50 Hz
- power consumption 250 W
- temperature 50-600 C°
- length of knife 25 cm
- length of supply cable 3 m



· equipment: cleaning brass brush, inbus, blades 25 cm, case

No.	specification	
35326	electric polystyrene cutter	1
35328	Spare knife for polystyrene cutter 14 cm	1
35329	Spare knife for polystyrene cutter 25 cm	1

**GUIDE BAR FOR POLYSTYRENE CUTTER**

· for 35323, 35326

No.	specification	
35327	Guide bar	1
35335	Spare knife - 30 cm	1



1

FESTA**POLYSTYRENE ELECTRIC CUTTER**

· temperature regulation

No.	specification
35325	220 W



1



NEW



FESTA

MILLING MACHINE FOR POLYSTYRENE

ALU

No.	specification	
24752	Ø 65 mm	1
24753	Ø 70 mm	1

NEW



DOWEL INTO THE INSULATION FOR LEAD SCREW SLEEVES

2x

No.	specification	
39240	white M10	1
39241	grey M10	1
39242	anthracite M10	1
39243	brown M10	1
39244	black M10	1



MILLING MACHINE FOR POLYSTYRENE

No.	specification	
24727	Ø 65 mm	1
24729	Ø 68 mm	1
24728	Ø 70 mm	1



FASTENER

100x

MADE IN EU

No.	specification		No.	specification	
39210	Ø 10 x 100 mm	1	39218	Ø 10 x 180 mm	1
39212	Ø 10 x 120 mm	1	39217	Ø 10 x 200 mm	1
39214	Ø 10 x 140 mm	1	39219	Ø 10 x 220 mm	1
39216	Ø 10 x 160 mm	1			

NEW



INSULATION WASHER

for screws Ø 6 and 8 mm

50x

No.	Specification	
39208	Ø 68 mm	1



INSULATION WASHER

No.	specification	
39206	Ø 40 mm	200
39207	Ø 60 mm	100



PLASTIC CORNER



No.	specification	
39238	3 m	25



ALU CORNER



No.	specification	
39245	AL 30 m x 5 cm	1



WASHER RABICO



No.	specification	
42420	Ø 30 mm	1



FENCING RABIC



No.	specification	
42312	1 m 50 bm 16 x 16 mm	1



LEVELING ROLL



No.	diameter	spikes high	length	
38950	Ø 69 mm	12 mm	25 cm	10
38951	Ø 69 mm	12 mm	40 cm	8
38952	Ø 122 mm	34 mm	25 mm	10
38953	Ø 122 mm	34 mm	40 cm	8
38954	Ø 122 mm	34 mm	60 mm	4

OUTSOLE WITH SPIKES PAIR



No.	specification	
38970	spikes 25 mm	1
38971	spikes 30 mm	1





DRYWALL SET

No.	specification	
34300	set 9 pcs	10
34303	cup	60



DRYWALL PANEL LIFTER

- lift 153 - 344 cm
- max. load 54 kg

No.	specification	
26775		1



FESTA

HOLDER OF BOARDS

2x

No.	specification	
36312		12



FESTA

HOLDER OF BOARDS

No.	specification	
36308	36 x 16,5 x 7,5 cm	10

NEW



SKIM COAT ROLLER

- handle 180 mm - 52630
- handle 250 mm - 52625
- handle 52010, 52011, 52012, 52020, 52030



No.	Specification	
52611	250 mm	50
52612	180 mm	10



PLASTERING SPLASH MACHINE

Zn



1

No.
37114

PLASTERING SPLASH MACHINE

Zn

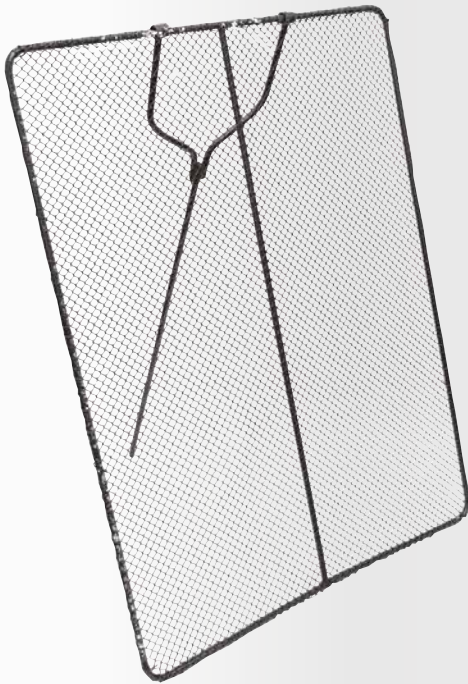

1

No. specification
37115

WIRE SHEET

No.	width	high	eye mesh	
37236	0,8 m	1 m	10 mm	1
37237	0,8 m	1 m	12 mm	1
37238	0,8 m	1 m	16 mm	1
37239	0,8 m	1 m	20 mm	1



SIEVE FOR STUCCO



No.	width	high	eye mesh	
37216	50 mm	50 mm	2 mm	1
37217	50 mm	50 mm	3 mm	1
37218	50 mm	50 mm	4 mm	1



WOODEN PLASTER



No.	length	thickness	width
37120	200 mm	1,7 mm	20 mm
37119	250 mm	1,7 mm	20 mm

MOQ
10

10

10



PE. SCAFFOLDING NET GREEN

No.	specification		
42120	2,5 x 20 m, 80 g/ m ²	green	5



REVISION DOOR FOR DRYWALL AND MASONRY



No.	specification		
82105	25 x 25 cm	wall	1



FIBER REINFORCING FOR CONCRETE

- +/- 150 g/ 50 kg cement
- 600 - 900 g/m² concrete or mortar



No.	váha		
42115	0,9 kg		9



DROP FORGED HOOK



No.	specification		
37229	14,5 cm		10



DROP HOOK ZINC COATED



No.	specification		
37231	14 cm single		10



DROP FORGED HOOK



No.	specification		
37232	14,5 cm		5



HOOK SET



No.	specification		
37230	16 cm		6



CRAMP ZINC COATED



No.	specification		
37233	320 x 10 mm		100
37234	320 x 12 mm		100



CRAMP



No.	specification		
37235	250 x 12 mm		1

**FESTA****HEATING TORCH - SET**

· Ø 17, 22, 40 mm



No.	specification
69918	2 kW, 1,5 m hose



10

FESTA**HEATING TORCH - SET**

· Ø 25, 35, 50 mm



No.	specification
69919	19,5 kW, 1,5 m hose



10

FESTA**HEATING TORCH - SET**

· Ø 55 mm



No.	specification
69904	60 kW, 850 mm, 5 m hose



8



FESTA
HEATING TORCH 3KW



No.	specification	
69914	300 mm + 2 m hose	5



FESTA
HEATING TORCH



No.	specification	
69900	Ø 35 mm, length 300 mm, without hose	10
69901	Ø 35 mm, length 300 mm + 3 m hose	5



FESTA
HEATING TORCH



No.	specification	
69902	Ø 55 mm, length 550 mm, without hose	10



FESTA
HEATING TORCH



No.	specification	
69903	Ø 55 mm, length 550 mm + 3 m hose	10



FESTA
HEATING TORCH



No.	specification	
69905	Ø 55 mm, length 850 mm, without hose	10

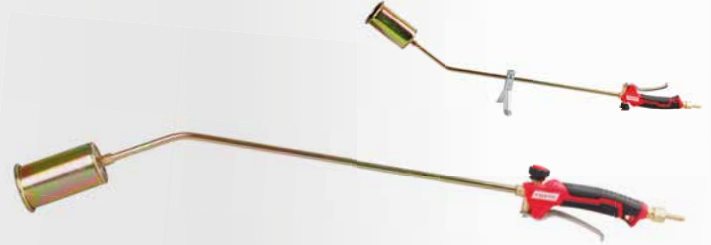

FESTA
HEATING TORCH



No.	specification	
69906	Ø 55 mm, length 850 mm + 3 m hose	5

**FESTA****HEATING TORCH - SET WITH REDUCTION VALVE**

· reduction valve for connection 10 and 33 kg



No.	specification
69917	Ø 60 mm, length 900 mm + 3 m hose 3 m



1

FESTA**HOSE FOR HEATING TORCH**

No.	specification
69910	3 m with ending
69911	5 m with ending
69912	10 m with ending



20

12

8

**FESTA****THREADED CARTRIDGE HEATING TORCH**

- max. temp. 1200 °C
- power 1,7 kW
- burner diam. Ø 20 mm



No.	specification
69930	piezo

20

**FESTA****PIERCEABLE CARTRIDGE HEATING TORCH**

- max. temp. 1200 °C
- power 1,7 kW
- burner diam. Ø 20 mm



No.	specification
69931	piezo

12



PROPANE BUTANE REDUCTION VALVE



No. specification
69923 W 21,8; G 3/8; 4 bar

1



PROPANE BUTANE REDUCTION VALVE



No. specification
69920 outlet pressure 4,0 bar
nominal flow rate 16 kg | h
inlet connection W 21,8 x 1 | 14" LH
outlet connection G3 | 8" LH

25



PRESSURE REGULATOR PROPAN - BUTAN

inlet pressure 25 bar
outlet pressure 0,5 - 4,0 bar
nominal flow rate 16 kg | h
inlet connection W 21,8 x 1 | 14" LH
outlet connection G3 | 8" LH



No. specification
69907

1



ONE WAY PRESSURE VALVE

out G 3/8L, for 2 kg PB bottle



No. specification
69928

1

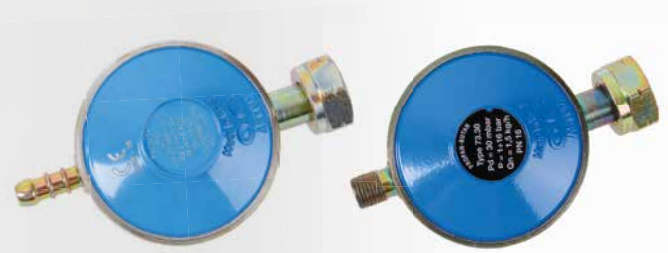

PRESSURE REGULATOR



No. specification
69908 30 mBar, prickle
69909 30 mBar, thread G 1/4L

1

1



PLASTER BOWL

No.	specification	
37121	conic	1



PLASTER BOWL

No.	specification	
37122	low	1



PLASTER BOWL



No.	specification	
33275	low, rubber	20



BUCKET ZN COATED

Zn

No.	specification	
39000	5 l	40
39001	10 l	30
39002	12 l	20
39003	15 l	20



BUCKET



No.	specification	
39005	5 l	1
39010	10 l	1
39012	12 l	1
39014	15 l with funnel	1
39020	20 l	1
39021	20 l with funnel	1



BUCKET



No.	specification	
39192	30 l	20
39193	45 l	20



ROUND TUB



No.	specification	
39045	45 l Ø 54 x 27 cm	1
39065	60 l Ø 60 x 35 cm	1
39090	90 l Ø 66 x 35 cm	1



RECTANGULAR TUB



No.	specification	
39145	45 l 71 x 40 x 21 cm	1
39165	65 l 71 x 40 x 30 cm	1
39190	85 l 77 x 48 x 30 cm	1

MASONRY PULLEY



No.	specification	
26780	0,5 t A with hook	1
26781	0,5 t B with eye	1
26782	0,5 t C with hook, with cover	1
26783	0,5 t D with eye, with cover	1





PACKAGING FOIL



No.	width	length	thickness	color	pcs	
38095	500 mm	600 m	8 µm	transparent	1	
38097	100 mm	150 m	20 µm	transparent	1	
38096	500 mm	200 m	23 µm	black	1	



PE BAG BUILDING WASTE - TRANSPARENT



No.	width	length	thickness	pcs	
39194	500 mm	1100 mm	0,16 mm	100 1	10
39196	600 mm	1200 mm	0,16 mm	110 1	10
39198	700 mm	1100 mm	0,16 mm	120 1	10
39200	500 mm	1100 mm	0,20 mm	100 1	10
39202	600 mm	1200 mm	0,20 mm	110 1	10
39204	700 mm	1100 mm	0,20 mm	120 1	10



PE BAG BUILDING WASTE - BLACK



No.	width	length	thickness	pcs	
39195	500 mm	1100 mm	0,16 mm	100 1	10
39197	600 mm	1200 mm	0,16 mm	110 1	10
39199	700 mm	1100 mm	0,16 mm	120 1	10
39201	500 mm	1100 mm	0,20 mm	100 1	10
39203	600 mm	1200 mm	0,20 mm	110 1	10
39205	700 mm	1100 mm	0,20 mm	120 1	10



WASTE BAG



No.	width	length	thickness	pcs	
38060	700 mm	1100 mm	0,08 mm	10	1
38063	700 mm	1100 mm	0,10 mm	3	1
38065	700 mm	1100 mm	0,20 mm	3	1



WASTE BAG



No.	width	length	thickness	pcs	
38050	500 mm	600 mm	0,04 mm	25	1
38052	600 mm	800 mm	0,04 mm	25	1
38054	700 mm	1100 mm	0,04 mm	25	1



PE BAG BUILDING WASTE



No.	width	length	thickness	
38055	1200 mm	1000 mm	0,08 mm	5

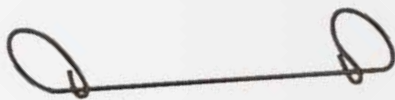

FIXING WIRE



No.	specification	
42365	1,25 100 mm	1
42366	1,25 125 mm	1
42367	1,25 140 mm	1
42368	1,25 160 mm	1



SPIRAL BINDER WIRE

No.	specification	
50052		12
50050		1



SPIRAL BINDER WIRE

No.	specification	
50051		2



EXCAVATION WARNING TAPE

No.	width	length	
38955	22 cm	20 m	1
38956	22 cm	50 m	1



EXCAVATION WARNING TAPE

No.	width	length	
38957	22 cm	20 m	1
38958	22 cm	50 m	1



EXCAVATION WARNING TAPE

No.	width	length	
38959	22 cm	20 m	1
38960	22 cm	50 m	1



WARNING TAPE

No.	specification	length	
38944	ZÁKAZ VSTUPU, SK	80 mm 250 m	8
38945	VSTUP ZAKÁZÁN, CZ	80 mm 250 m	8



WARNING TAPE

No.	length	
38948	80 mm 250 m	8



WARNING TAPE

No.	length	
38946	80 mm 250 m	8



WARNING TAPE SELF - ADHESIVE

No.	length	specification	
38947	48 mm 33 m	right	48
38961	48 mm 33 m	left	48



MARKING TAPE

No.	width	length	thickness	
38949	50 mm	50 m	0,15 mm	36

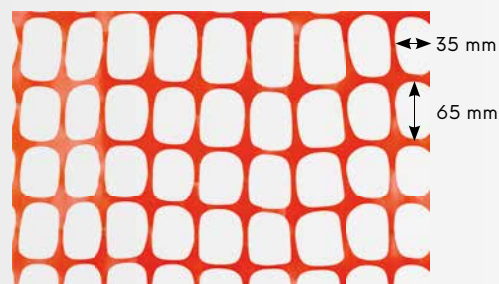

SAFETY MESH FENCING



No.	specification	
42190	1,2 x 50 m HDPE 140g/m ²	1



PVC TAPES SET

5x

No.	width	length	thickness	
38931	19 mm	5 m	0,13 mm	100



PVC TAPE BLACK

No.	width	length	thickness	
38932	19 mm	10 m	0,13 mm	10



PVC TAPES SET

No.	width	length	thickness	
38925	19 mm	10 m	0,13 mm	10



PVC TAPE, BLACK

No.	width	length	thickness	
38968	19 mm	10 m	0,19 mm	10



TEXTILE TAPE - BLACK

No.	width	length	
38927	19 mm	10 m	10



TEXTILE TAPE, KARPET

No.	width	length	
38980	48 mm	10 m	24
38981	48 mm	20 m	24



BOTH SIDES ADHESIVE TAPE WITH REINFORCEMENT

No.	width	length	
38924	50 mm	10 m	1
38964	50 mm	25 m	1



BOTH SIDES ADHESIVE TAPE

PP Polypropylen		No.	width	length	
		38929	50 mm	10 m	1
		38966	50 mm	25 m	1



BOTH SIDES ADHESIVE TAPE

MADE IN EU		No.	width	length	
		38990	19 mm	5 m	48
		38991	25 mm	5 m	36

FESTA**PROFESSIONAL
REINFORCED WATERPROOF TAPE**

No.	width	length	
38995	48 mm	25 m	24

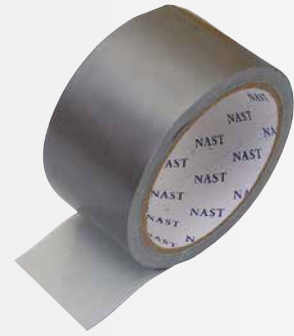
**REINFORCED WATERPROOF TAPE**

No.	width	length	
38965	30 mm	10 m	1
38928	50 mm	10 m	72
38934	50 mm	45 m	24



blue dolphin tapes™

DUCT TAPE, WATERPROOF

No.	width	length	
37275	48 mm	50 m	24



blue dolphin tapes™

MASKING TAPE

No.	width	length	
37271	38 mm	20 m	24
37270	48 mm	20 m	24
37272	48 mm	50 m	24



blue dolphin tapes™

PE MASKING TAPE FOR WINDOWS

for 30 days



No.	width	length	
37273	48 mm	50 m	24



blue dolphin tapes™

PAPER MASKING TAPE

No.	width	length	
37263	38 mm	50 m	24
37264	48 mm	50 m	24

**PVC TAPE ADHESIVE**

No.	width	length	
37266	30 mm	33 m	60
37267	38 mm	33 m	48
37268	50 mm	33 m	36

**PAPER MASKING TAPE**

No.	width	length	
37255	19 mm	50 m	12
37256	25 mm	50 m	12
37257	30 mm	50 m	7
37258	38 mm	50 m	6
37259	50 mm	50 m	6

**PACKAGING PVC TAPE**

No.	width	length	
38942	50 mm	50 m	72



PLATED TAPE



No.	width	length	
38972	50 mm	50 m	1
38973	50 mm	100 m	1



ALU SELF ADHESIVE TAPE



No.	width	length	
38963	48 mm	10 m	1
38943	48 mm	45 m	24



ANTI - SLIP TAPE

No.	width	length	thickness	
37280	25 mm	15 m	0,8 mm	72
37281	50 mm	15m	0,8 mm	36



SELF WELDING TAPE

No.	width	length	
38930	19 mm	5 m	100



FIBERGLASS TAPE SELF ADHESIVE

No.	width	length	
38935	50 mm	20 m	60
38937	50 mm	45 m	36
38939	50 mm	90 m	24
38940	50 mm	153 m	24



FIBERGLASS FELT

No.	width	length	
38941	50 mm	25 m	40



TEFLON TAPE



No.	width	length	thickness	
38969	19 mm	15 m	0,2 mm	10



TEFLON TAPE



No.	width	length	thickness	
38933	12 mm	10 m	0,075 mm	10



TEFLON TAP

· for water and gas installations



No.	width	length	
38926	2 mm	150 m	20



PACKING TAPE DISPENSER

No.	
38985	1



BINDING TAPE, VELCRO

No.	specification	
45471	12 mm x 5 m	1



VELCRO TAPE 3 PCS



No.	width	length	
37295	20 mm	150 mm	1
37296	20 mm	200 mm	1
37297	20 mm	250 mm	1

NEW

**FESTA**

CAULKING GUN
WITH REVERSE STEP SWITCH
AND ADJUSTABLE THRUST RATIO

No. specification
38027



NEW

**FESTA**

CAULKING GUN
WITH REVERSE STEP SWITCH

No. specification
38028





FESTA

CAULKING GUN HEAVY DUTY

No.	specification	
38013		12



FESTA

CAULKING GUN

No.	specification	
38001		24



FESTA

CAULKING GUN

No.	specification	
38012		6



FESTA

CAULKING GUN

No.	specification	
38024		1



CAULKING GUN WITH BACPCSTEP

No.	specification	
38010	6 square	24



CAULKING GUN

No.	specification	
38025		24



FESTA

CAULKING GUN FOR CHEMIC ANCHOR 380 ML

No.	specification	
38020		12



CAULKING GUN

No.	specification	
38006		12



CAULKING GUN

No.	specification	
38002	6 square	24



CAULKING GUN - PLASTIC

No.	specification	
38003	6 square	24



CAULKING GUN

No.	specification	
38007		24



CAULKING GUN - SEMI CLOSED

No.	specification	
38008		24



CAULKING GUN WITH TEETH

No.	specification	
38009		24

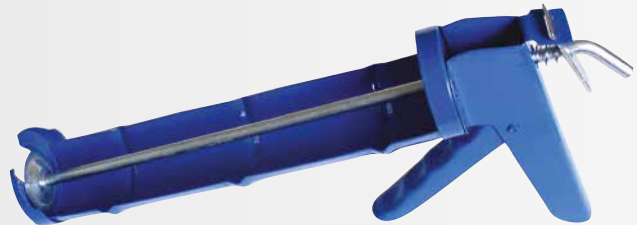

CAULKING GUN

No.	specification	
38000		24



FESTA

CAULKING GUN

ALU		
No.	specification	
38005	310 ml	20
38014	tip 3 pcs	100



FESTA

CAULKING GUN

ALU		
No.	specification	
38004	600 ml	12
38014	tip 3 pcs	100



FESTA

FOAM GUN WITH TEFLON COATING



No. specification
38018

20



FESTA

FOAM GUN WITH TEFLON COATING



No. specification
38017

20



FESTA

FOAM GUN



No. specification
38016

20



FESTA

FOAM GUN FOR FOAMS



No. specification
38015

20



FOAM GUN



No. specification
38031

20



FESTA

FOAM GUN ABS

No. specification
38022 ABS

20



FOAM GUN

No. specification
38021

24



SPARE NOZZLE GUN TEFLON

· for PU guns 38015, 38016, 38017, 38018



No.	specification	
38030		5

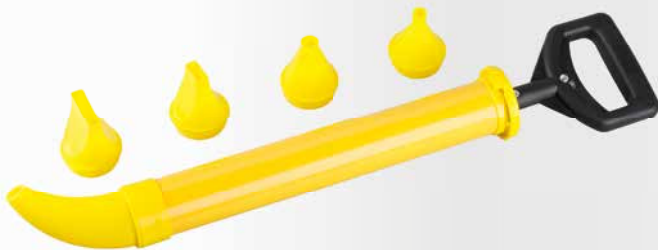

CAULKING GUN

· capacity 1,5 l



No.	specification	
38026	5x tip	25



POINTING BAG



No.	specification	
38042	3x tip	6



FESTA

HEATING GUN

voltage	230V / 50Hz
power consumption	2000W
position of switch	0 - I (350°C) - II (600°C)
accessories	stainless extensions - 4 pcs



No.	specification	
35320	2000 W	1



FESTA

HEATING GUN WITH REGULATION OF TEMPERATURE AND AIR FLOW

· digital display

voltage	230V / 50Hz
power consumption	2000W
position of switch	0 - I (50°C) - II (50 - 600°C)
air flow	250 - 500 l/min.
accessories	stainless extensions - 4 pcs



No.	specification	
35322	2000 W	1



HOT MELT GLUE GUNS

FESTA

HOT MELT GLUE GUN - WIRELESS

· Ø glue stick 11,2 mm



No.	specification
89975	80 W 230 V



HOT MELT GLUE GUN

· Ø glue stick 7,2 mm



No.	specification
89970	15 W 230 V



HOT MELT GLUE GUN

· Ø glue stick 11,2 mm



No.	specification
89973	60 W 230 V



HOT MELT GLUE STICK

No.	Ø	length		
89980	7,2 mm	100 mm	12 pcs	100
89988	7,2 mm	100 mm	1 kg	25



HOT MELT GLUE STICK

No.	Ø	length		
89985	11,2 mm	200 mm	10 pcs	50
89987	11,2 mm	200 mm	1 kg	25



HOT MELT GLUE STICK

No.	Ø	length		
89989	7,2 mm	100 mm	12 pcs	100
89990	11,2 mm	200 mm	10 pcs	50



PAINT BRUSHES



PAINT BRUSH NATURAL

No.	width	thickness	length	
52212	20 mm	15 mm	40 mm	12
52213	30 mm	15 mm	45 mm	12
52214	40 mm	15 mm	45 mm	12
52215	50 mm	15 mm	50 mm	12
52216	60 mm	15 mm	60 mm	12
52217	70 mm	15 mm	65 mm	12
52218	80 mm	15 mm	65 mm	12
52220	100 mm	15 mm	70 mm	12



PAINT BRUSH

No.	width	thickness	length	
52202	20 mm	12,5 mm	38 mm	12
52203	30 mm	13 mm	38 mm	12
52204	40 mm	14 mm	44 mm	12
52205	50 mm	16 mm	44 mm	12
52206	60 mm	17 mm	52 mm	12
52208	80 mm	17 mm	52 mm	12
52207	100 mm	18 mm	52 mm	12



RADIATOR PAINT BRUSH

No.	width	thickness	length	
52283	25 mm	10 mm	44 mm	12
52284	38 mm	10 mm	44 mm	12
52285	50 mm	10 mm	44 mm	12
52286	62 mm	10 mm	50 mm	12
52288	76 mm	10 mm	50 mm	12



PAINT BRUSH SET - PLASTIC HANDLE

No.	specification	
52070	20, 30, 50 mm	50

3x



PAINT BRUSH SET - PLASTIC HANDLE

5x



No.	specification	
52071	15 mm, 25 mm, 40 mm, 60 mm, 80 mm	50



SCRAPER FOR PAINT AND LACQUER

No.
37005



PAINT BRUSH PROFESSIONAL



No.	specification	
52075	Ø 90 mm	10



PAINT BRUSH PROFESSIONAL



No.	width	length	
52076	170 mm	80 mm	10



PAINT BRUSH

No.	specification	length	
52077	Ø 105 mm	70 mm	12



PAINT BRUSH

No.	width	length	
52078	170 mm	70 mm	12

APPLICATION OF THE ROLLERS		PAINTS OR VARNISHES (LACQUERS)												
		DISPERSION	ANTICORRO-SIVE	RESIN	OIL	WATER DIL.	POLYESTER	BINDER	GLAZING	LATEX	EPOXY	2-COMPO-NENT	THICK	ACRYLIC
MATERIAL	TICKNESS OF PILE mm													
PES	20	•						•		•			•	
PES	20	•	•			•		•		•				•
PAC	18	•						•		•				
PAC	12, 13	•								•				
PAD	18, 21	•								•				
PAD	13	•	•							•				
LAMBSKIN	23	•								•				
NYLON	13		•	•	•	•	•			•	•	•		
VELOUR	4		•	•			•				•	•	•	
MICROFIBRE	10					•			•	•				
MOLITAN				•		•								•



PAINTING SET

PAC
MADE IN EU

No.	roller	length	handle	roller	pile	box
52600	polster 4	180 mm	Ø 8 mm	Ø 53 mm	18 mm	1

PAINTING SET

PES
MADE IN EU

No.	roller	length	handle	roller	pile	box
52610		180 mm	Ø 6 mm	Ø 42 mm	20 mm	25
52605		250 mm	Ø 6 mm	Ø 42 mm	20 mm	20



PAINTING SET

- 1x paintroller PAD 13mm/10 cm
- 1x paintroller PAC 12mm/10 cm
- 1x paintroller PES 11mm/10 cm
- handle
- bowl

MADE IN EU

No.	roller	length	handle	roller	pile	box
52602						10



CORNER PAINTROLLER POLYACRYL

PAC
MADE IN EU

No.	roller	length	handle	roller	pile	box
52601	with handle		Ø 6 mm	18 mm		1



PAINTROLLER POLYACRYL

	No.				
52331	100 mm	Ø 6 mm	Ø 17 mm	12 mm	50
52334	250 mm	Ø 8 mm	Ø 48 mm	12 mm	10



PAINTROLLER POLYACRYL

	No.				
52391	polster 5 250 mm	Ø 8 mm	Ø 54 mm	18 mm	10



PAINTROLLER POLYACRYL

	No.				
52328	polster 5 250 mm	Ø 8 mm	Ø 54 mm	18 mm	10
52456	polster 7 250 mm	Ø 8 mm	Ø 67 mm	18 mm	10



PAINTROLLER POLYAMIDE

	No.				



PAINTROLLER POLYESTER

	No.				
52315	polster 5 180 mm	Ø 8 mm	Ø 54 mm	20 mm	10



ROLLER FOR GLAZING - NYLON

	No.				
52421	100 mm	Ø 6 mm	Ø 17 mm	13 mm	50
52424	250 mm	Ø 8 mm	Ø 48 mm	13 mm	10



PAINTROLLER, POLYESTER

	No.				
52305	180 mm	Ø 6 mm	Ø 42 mm	20 mm	10
52306	250 mm	Ø 6 mm	Ø 42 mm	20 mm	10



VARNISHING ROLLER, FOAM

	No.				
52471	straight 100 mm	Ø 6 mm	Ø 35 mm		50

NEW

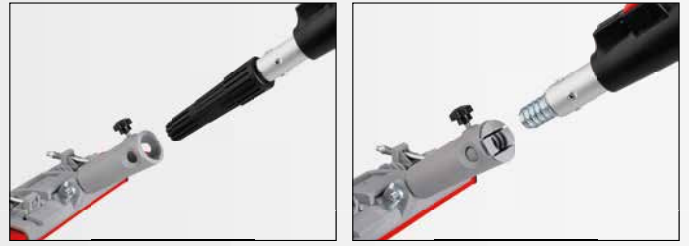

FESTA®

TELESCOPIC POLE

- thread for 31610, 34203

No.	Specification	
52011	88 - 140 cm	1



TELESCOPIC POLE

ALU

No.	length		
52010	120 cm	ALU	50
52012	240 cm	ALU	25



TELESCOPIC POLE

No.	length		
52020	300 cm	steel	10



TELESCOPIC POLE

No.	length		
52030	240 cm	fiberglass	6



PAINT TRAY

MADE IN EU



No.	specification	
52662	150 x 270 mm 100 mm	1
52666	260 x 290 mm 180 mm	1
52671	330 x 340 mm 250 mm	1

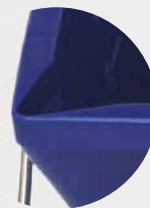

PAINT BUCKET

MADE IN EU



No.		
52694	8 l	25
52695	12 l	20



WIPE GRID



No.	width	high	
52652	230 mm	250 mm	100
52656	270 mm	290 mm	100



HANDLE



No.	specification	
52640	5 cm Ø 6 mm	100
52645	8,5 cm Ø 6 mm x 27 mm	100

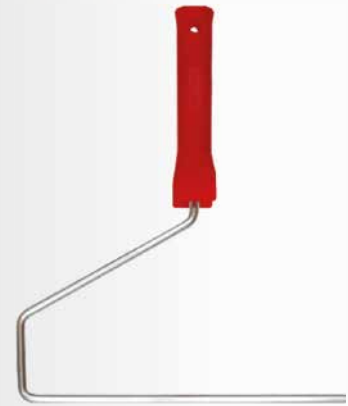

HANDLE



No.	specification	
52630	18 cm Ø 6 mm	100
52635	25 cm Ø 6 mm	100
52620	18 cm Ø 8 mm	50
52625	25 cm Ø 8 mm	50



COVER TAPE SELF ADHESIVE WITH COVER SHEET

No.	width	length	
37243	55 cm	30 m	60
37244	110 cm	30 m	30
37245	140 cm	30 m	30
37246	180 cm	15 m	30
37290	210 cm	20 m	30
37247	240 cm	15 m	30
37291	270 cm	16 m	30



SAFETY OVERALL WITH HOOD

No.	specification	
50585	size M	1
50586	size L	1
50587	size XL	1
50588	size XXL	1



COVER SHEET FOR DOOR WITH ZIPPER

No.	specification	
37248	1,2 x 2,2 m tape 100 µm 45 mm x 25 m	25



COVER SHEET

No.	width	thickness	
37250	4 x 5 m	0,007 mm	100
37251	4 x 12,5 m	0,007 mm	50
37252	2 x 50 m	0,007 role	20



COVER SHEET

No.	specification	thickness	
37253	4 x 5 m	0,03 mm	100



CORRUGATED CARDBOARD



No.	width	length	
54008	1 m	10 m	1



EKONOMIK ** STANDARD *** PROFI ****

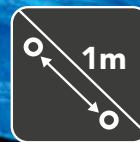

- Double welded hems with polypropylen cord
- Silver layer for increased reflection of sunshine
- Sluminium eyelets in the distance of 1 m



TARPAULIN EKONOMIK

blue



No.	specification	
25369	2 x 2 m	50
25370	2 x 3 m	20
25371	3 x 4 m	10
25372	3 x 5 m	10
25373	4 x 5 m	10

No.	specification	
25374	4 x 6 m	5
25376	5 x 8 m	5
25378	6 x 10 m	2
25379	8 x 12 m	2
25380	10 x 15 m	2



TARPAULIN STANDARD

blue-silver



70 g/m²

No.	specification		No.	specification	
25155	2 x 2 m	50	25025	5 x 5 m	10
25006	2 x 3 m	50	25030	5 x 6 m	10
25009	3 x 3 m	35	25040	5 x 8 m	5
25012	3 x 4 m	20	25048	6 x 8 m	5
25015	3 x 5 m	10	25060	6 x 10 m	5
25016	4 x 4 m	10	25096	8 x 12 m	2
25020	4 x 5 m	10	25150	10 x 15 m	2
25024	4 x 6 m	10	25153	15 x 20 m	1



TARPAULIN STANDARD

green



70 g/m²

No.	specification	
25179	2 x 2 m	50
25180	2 x 3 m	50
25195	2 x 8 m	20
25181	3 x 4 m	20
25182	3 x 5 m	10
25183	4 x 5 m	10

No.	specification	
25184	4 x 6 m	10
25186	5 x 8 m	5
25188	6 x 10 m	5
25189	8 x 12 m	2
25190	10 x 15 m	2



TARPAULIN PROFESSIONAL

blue-silver



140 g/m²

No.	specification		No.	specification	
25206	2 x 3 m	25	25240	5 x 8 m	4
25212	3 x 4 m	10	25248	6 x 8 m	3
25215	3 x 5 m	8	25260	6 x 10 m	3
25220	4 x 5 m	8	25296	8 x 12 m	2
25224	4 x 6 m	8	25350	10 x 15 m	1
25230	5 x 6 m	8			



TARPAULIN PROFESSIONAL

green-green

200 g/m²

No.	specification	
25160	2 x 3 m	15
25171	2 x 8 m	1
25162	3 x 5 m	5
25163	4 x 5 m	4

TARPAULIN ROUND

blue-silver

120 g/m²

No.	specification	
25003	Ø 3,6 m	15
25004	Ø 4,5 m	5
25005	Ø 5,5 m	4
25002	Ø 6,5 m	3



TENSIONER FOR TARPAULINS

4x

No.	specification	
25400	20 cm	1



APPLICATOR OF EYELETS FOR PE TARPAULINS

No.	specification	
25410	applicator of eyelet + 25 eyelets	1



EYELETS FOR PE TARPAULINS

10x

No.	specification	
25001		1



SNAP HOOKS CHAINS AND WIRE ROPES



TURN BUCKLE

DIN 1480 **Zn**

No.	specification	
50100	5 x 70 mm	10
50101	6 x 90 mm	10
50102	8 x 125 mm	10
50103	10 x 150 mm	10

No.	specification	
50104	12 x 200 mm	10
50106	16 x 230 mm	10
50108	20 x 220 mm	10



SNAP HOOK

DIN 5299 C **Zn**

No.	specification	
51204	4 mm	10
51205	5 mm	10
51206	6 mm	10
51207	7 mm	10
51208	8 mm	10

No.	specification	
51209	9 mm	10
51210	10 mm	10
51211	11 mm	10
51212	12 mm	10



RAPID QUICK LINK

Zn

No.	specification	
51241	4 mm	10
51242	5 mm	10
51243	6 mm	10
51244	7 mm	10

No.	specification	
51245	8 mm	10
51246	10 mm	10
51247	12 mm	10



S HOOK

Zn

No.	specification	
51271	3 mm	10
51272	4 mm	10
51273	5 mm	10
51274	6 mm	10

No.	specification	
51275	7 mm	10
51276	8 mm	10
51278	10 mm	10



EYE NUT

DIN 5820 **Zn**

No.	specification	
51320	6 mm	10
51321	8 mm	10
51322	10 mm	10
51323	12 mm	10

No.	specification	
51324	14 mm	10
51325	16 mm	10
51327	20 mm	10



EYE BOLT

DIN 5820 **Zn**

No.	specification	
51300	6 mm	10
51301	8 mm	10
51302	10 mm	10
51303	12 mm	10
51304	14 mm	10

No.	specification	
51305	16 mm	10
51306	18 mm	10
51307	20 mm	10
51308	22 mm	10

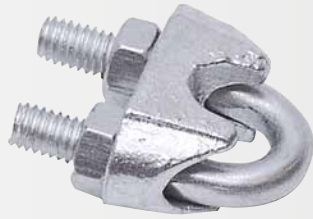

WIRE ROPE CLIP

Zn

No.	specification	
51280	3 mm	10
51281	5 mm	10
51282	6 mm	10
51283	8 mm	10

No.	specification	
51284	10 mm	10
51286	12 mm	10
51287	14 mm	10
51288	16 mm	10



SWIVEL SNAP HOOK

Zn

No.	specification	
51220	53 mm	10
51221	67 mm	10
51222	76 mm	10



WIRE ROPE CLIP

Zn

No.	specification	
51225	3,8 mm	10
51226	4,5 mm	10
51227	6,0 mm	10



SHORT LINK CHAIN

DIN 5685 A Zn

No.	size of eye	length	
51402	2 x 10 mm	110 m	1
51403	3 x 16 mm	60 m	1
51404	4 x 21 mm	40 m	1
51405	5 x 23 mm	30 m	1

No.	size of eye	length	
51406	6 x 24 mm	18 m	1
51407	7 x 50 mm	16 m	1
51408	8 x 32 mm	10 m	1
51410	10 x 39 mm	10 m	1



SHORT LINK CHAIN

DIN 5686 Zn

No.	Ø of material	length	
51430	1,4 mm	150 m	1
51431	1,6 mm	150 m	1
51432	1,8 mm	150 m	1

No.	Ø of material	length	
51433	2,0 mm	118 m	1
51435	2,5 mm	70 m	1
51436	2,8 mm	50 m	1



LONG LINK CHAIN

DIN 5685 C Zn

No.	size of eye	length	
51412	2 x 12 mm	80 m	1
51413	3 x 26 mm	60 m	1
51414	4 x 32 mm	38 m	1
51415	5 x 35 mm	32 m	1

No.	size of eye	length	
51416	6 x 43 mm	18 m	1
51417	7 x 50 mm	16 m	1
51418	8 x 54 mm	10 m	1
51420	10 x 65 mm	10 m	1



LINK CHAIN



No.	specification	
51450	6 mm 25 m red-white	1



ROPE AND WIRE CONNECTOR - DOUBLE

DIN 5685 C **Zn**

No.	specification	
51348	Ø 10 mm	10



ROPE AND WIRE CONNECTOR

DIN 5685 C **Zn**

No.	specification	
51338	Ø 5 mm	10
51341	Ø 10 mm	10



WIRE ROPE THIMBLE

Zn

No.	specification	
51257	Ø 14 mm	10
51258	Ø 16 mm	10
51259	Ø 18 mm	10
51260	Ø 20 mm	10
51261	Ø 22 mm	10
51262	Ø 24 mm	10
51263	Ø 26 mm	10
51264	Ø 28 mm	10
51265	Ø 30 mm	10



HAND WINCH WITH WIRE ROPE AND HOOK

Zn

No.	load capacity	length	
26720	300 kg	8 m	1
26705	450 kg	8 m	1
26721	500 kg	8 m	1
26722	800 kg	8 m	1
26706	900 kg	8 m	1
26707	1350 kg	8 m	1

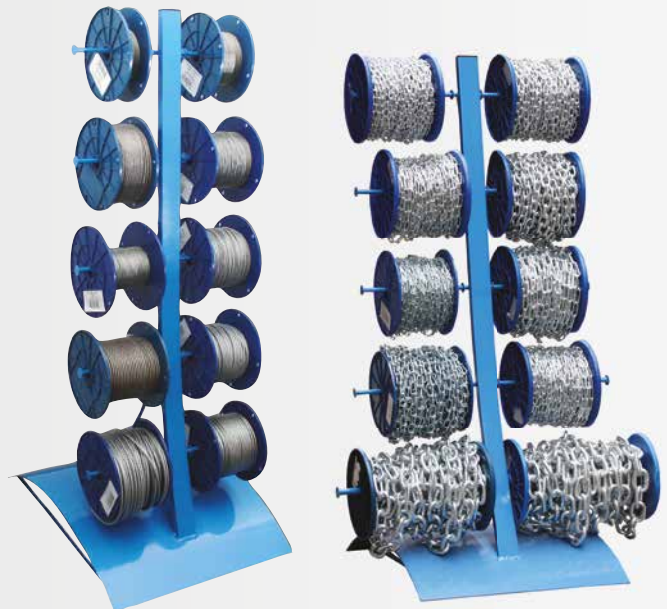

STAND FOR ROPES, STAND FOR CHAINS

No.	specification	
51196	Promotional stand for chains staffed	10
51197	Promotional stand for ropes staffed	10
51198	Promotional stand for chains	10
51199	Promotional stand for ropes	10



WIRE ROPE ZN COATED

Zn

No.	rope diameter	length	
51100	Ø 1 mm	500 m	1
51101	Ø 1,2 mm	500 m	1
51102	Ø 1,5 mm	500 m	1
51103	Ø 2 mm	200 m	1
51104	Ø 3 mm	200 m	1
51105	Ø 4 mm	100 m	1
51106	Ø 5 mm	75 m	1
51107	Ø 6 mm	75 m	1
51130	Ø 8 mm	75 m	1
51131	Ø 10 mm	50 m	1
51132	Ø 12 mm	50 m	1

WIRE ROPE ZN COATED IN PVC COVER

Zn

No.	rope diameter	length	
51108	Ø 2/3 mm	200 m	1
51109	Ø 3/4 mm	100 m	1
51110	Ø 4/5 mm	75 m	1
51111	Ø 5/6 mm	50 m	1



STAINLESS ROPE

INOX

No.	rope diameter	length	
51120	Ø 1 mm	300 m	
51121	Ø 1,2 mm	300 m	1
51122	Ø 1,5 mm	300 m	1
51123	Ø 2 mm	200 m	1
51124	Ø 3 mm	200 m	1
51125	Ø 4 mm	100 m	1
51126	Ø 5 mm	75 m	1
51127	Ø 6 mm	75 m	1



FESTA

LED LAMP ON BUILDING SITE



No.	specification
37611	

1

HALOGEN LAMP



No.	specification	
37600	120 W	1
37601	400 W	1

HALOGEN LIGHT BULB

No.	specification	
37604	120 W	1
37606	250 W	1
37605	400 W	1



FESTA

LED LAMP ON BUILDING SITE

· max height 180 cm



No.	specification
37615	20 W
37616	2 x 20 W

1

1

HALOGEN LAMP FOR BUILDING SITE

· max height 180 cm



No.	specification
37602	400 W
37603	2 x 400 W

2

2



TELESCOPIC LADDER FOLDABLE

· max. load 150 kg



No.	specification	
48415	1,9 / 3,8 m	6/12 steps



WORK PLATFORM, FOLDABLE

· max. load 150 kg



No.	specification	
48420		1

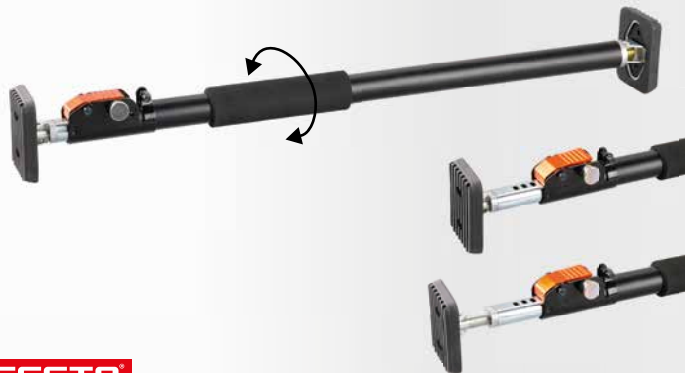

FESTA

SUPPORTING POLE

· max. load 40 kg



No.	specification	
52060	66 - 115 cm	1
52065	160 - 290 cm	1



TELESCOPIC LADDER

· max. load 150 kg



No.	specification	
48410	3,2 m	11 steps
48411	3,8 m	13 steps



ADJUSTABLE PROPS

· 48449 cage for adjustable props



No.	specification	
48452	160 - 290 cm	1
48453	180 - 320 cm	1
48454	200 - 360 cm	1
48455	250 - 440 cm	1
48456	260 - 380 cm	1
48457	220 - 400 cm	1



SUPPORTING POLE



No.	specification	
52050	50 - 115 cm	1
52055	115 - 290 cm	1



WOOD SCREWS IN BOX

pcs	content
60	3,0 x 12 mm
50	3,0 x 16 mm
40	3,0 x 20 mm
50	3,5 x 20 mm
40	3,5 x 30 mm
25	4,0 x 30 mm
20	4,0 x 40 mm
15	5,0 x 50 mm
10	5,0 x 60 mm



WOOD SCREWS AND WALL DOWELS IN BOX

wood screws	
pcs	content
40	3,5 x 30 mm
25	4,0 x 40 mm
12	5,0 x 50 mm
8	6,0 x 60 mm

wall dowels	
pcs	content
40	5 x 25 mm
25	6 x 30 mm
12	8 x 40 mm
8	10 x 50 mm

310x



170x



No. specification
55642

1

No. specification
55645

1

WOOD SCREW

pcs	content
350	3,0 x 16 mm
280	3,0 x 20 mm
220	3,0 x 25 mm
250	3,5 x 20 mm
240	3,5 x 25 mm
180	3,5 x 3, mm
280	4,0 x 16 mm
80	4,0 x 30 mm
40	4,0 x 40 mm
30	4,0 x 50 mm
25	5,0 x 50 mm
25	5,0 x 60 mm



2000x

No. specification
55640 2000 pcs

1



CHIMNEY DOORS TIN



No. specification
65062

1



CHIMNEY DOORS KOMAX



No. specification
65063 šedá
65064 bílá

1



CHIMNEY DOORS GALVANIZED



No. specification
65065

1



332

WINLAND GARDEN PRUNERS



338

GARDEN PRUNERS



339

GARDEN SAWS



340

MACHETES AND GARDEN TOOLS



341

GARDEN TOOLS



343

TRIMMER LINES



344

SHARPENERS



345

GARDEN SUPPORTING BAR



346

BONDED WEB FABRIC



348

WATERING SYSTEM AQUATIC AND ROSA



360

HOSE REELS AND HOSE CARTS



362

HOSE CONNECTORS BRAS



364

HOSE CONNECTORS



365

PRESURE SPRAYER AND COMPRESSORS



367

RAKE



372

SPADES, SHOVELS AND FORKS



378

HOES AND PICKAXES



381

BRUSHES



384

SNOW SHOVELS



386

WOODEN, ALU AND FIBERGLASS BUTT

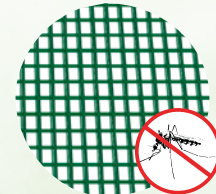

387

INSECT SCREEN

GARDEN TOOLS AND FENCING

330 - 397



389

FENCES



392

POLE ANCHOR AND ANCHORAGE SCREW



394

SHADING NETS



395

GRILL TOOLS



PRUNERS

- professional garden pruners
- high quality used materials
- quality manufactured
- ergonomic grips



PRUNERS

· blade HCS SK - 5, japanese steel



No.	dimensions	
45020	205 mm	10
44980	spare spring	1



PRUNERS

· blade HCS SK - 5, japanese steel



No.	dimensions	
45023	205 mm	10
44980	spare spring	1



PRUNERS

· blade HCS SK - 5, japanese steel



No.	dimensions	
45063	215 mm	10
44981	spare spring	1



PRUNERS

· blade HCS SK - 5, japanese steel



No.	dimensions	
44972	215 mm	10
44981	spare spring	1



PRUNERS

SK5

No.	dimensions	
45099	190 mm	10
44983	spare spring	1



PRUNERS

SK5

No.	dimensions	
45098	220 mm	10
44983	spare spring	1



PRUNERS

SK5

TEFLON

No.	dimensions	
45095	200 mm	10
44982	spare spring	1

· turning handle



PRUNERS

· blade HCS SK - 5, japanese steel

SK5

TEFLON

No.	dimensions	
45096	220 mm	6
44982	spare spring	1



PRUNERS

· blade HCS SK - 5, japanese steel

SK5

TEFLON

No.	dimensions	
45097	250 mm	10
44981	spare spring	1



PRUNERS

INOX

No.	dimensions	
45089	160 mm	10



PRUNERS

INOX

No.	dimensions	
45088	160 mm	10



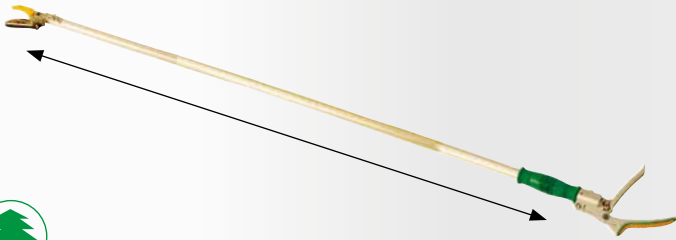

PRUNERS

No.	dimensions
45017	



10



SPARE SPRING

No.	for pruners	
44981	45021, 45025, 45063, 45097	1
44980	45020, 45023	1
44983	45098, 45099 150 cm	1
44982	45027, 45095, 45096	1
44984	45110, 45014, 45026	1
44985	45018	1
44986	45019, 45029, 44970	1
44987	45021	1
44988	44971	1
44989	45015, 45016	1



SPARE BLADE

· for pruners 45095, 45027

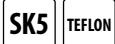

No.	dimensions
45094	



20



PRUNERS FOR BRANCHES

· blade HCS SK - 5, japanese steel



No.	dimensions
44991	76 cm



12



PRUNERS FOR BRANCHES



PRUNERS FOR BRANCHES TELESCOPIC

· blade HCS SK - 5, japanese steel



No.	dimensions
44992	70 - 103 cm



10



PRUNERS



No.	dimensions
44996	61 cm, wavy edge



12



PRUNERS



No.	dimensions	
44997	61 cm, straight edge	12



SHEARS GRASS 360°



No.	dimensions	
44998		6



SHARPENER FOR SCISSORS AND KNIVES 6 IN 1



No.	dimensions	
45068		10



SHARPENER FOR SCISSORS AND KNIVES



No.	dimensions	
45048		20

PRUNERS



No.	dimensions	
45010	190 mm	12
44984	Spare spring	1

PRUNERS



No.	dimensions	
45014	190 mm	12
44984	Spare spring	1

PRUNERS



No.	dimensions	
45026	150 mm	12
44985	Spare spring	1

PRUNERS



No.	dimensions	
45018	210 mm metal tipped	10



PRUNERS

SKS TEFLON

No.	dimensions
45019	210 mm



10



FESTA

PRUNERS

nylon handle

SKS TEFLON NYLON

No.	dimensions
45021	200 mm



6



PRUNERS

ALU

No.	dimensions
45025	200 mm



12



PRUNERS

INOX

No.	dimensions
44970	210 mm



10



PRUNERS

TEFLON

No.	dimensions
45027	200 mm



10



PRUNERS

INOX ALU

No.	dimensions
45029	200 mm



24



PRUNERS

INOX

No.	dimensions
44971	160 mm



10



PRUNERS

No.	dimensions
45016	180 mm



12



PRUNERS



No.	dimensions
45015	190 mm, straight

12



CASE FOR GARDEN PRUNERS

No.	dimensions
37317	

1



GRASS SHEARS



No.	dimensions
45011	300 mm

1



GRASS SHEARS



No.	dimensions
45012	370 mm, turning 180°

1



PRUNERS FOR BRANCHES

· nylon handle



No.	dimensions
44999	540 mm, round

12



FESTA

PRUNERS FOR BRANCHES



No.	dimensions
45000	750 mm, round

6



FESTA

PRUNERS FOR BRANCHES



No.	dimensions
45001	710 mm, round

6



FESTA

PRUNERS FOR BRANCHES

TEFLON

No.	dimensions	
45002	750 mm, with ratchet	12



FESTA

PRUNERS FOR BRANCHES, TELESCOPIC

TEFLON

No.	dimensions	
45003	660-900 mm, telescopic	6



PRUNERS

TEFLON NYLON

No.	dimensions	
44995	440 160 mm	12



FESTA

PRUNERS FOR BRANCHES

TEFLON

No.	dimensions	
45005	580 230 mm, wavy edge	6



PRUNERS

No.	dimensions	
45009	500 190 mm, wavy edge	6



FESTA

PRUNERS FOR BRANCHES

TEFLON

No.	dimensions	
45006	580 230 mm, straight edge	6



PRUNERS

No.	dimensions	
45008	500 190 mm, straight edge	6



FESTA

PRUNERS FOR BRANCHES TELESCOPIC

TEFLON

No.	dimensions	
45007	670-870 230 mm, wavy edge	6



FESTA

FOLDING SAW

 · 3 x sharpened and heat treated teeth

No.	dimensions	
45061	150 mm	12



FESTA

FOLDING SAW

 · 3 x sharpened and heat treated teeth

No.	dimensions	
45060	180 mm	6



FESTA

SAW WITH CASE

 · 3 x sharpened and heat treated teeth

No.	dimensions	
45062	260 mm	24



FESTA

PRUNING HAND SAW

 · 3 x sharpened and heat treated teeth

No.	dimensions	
24152	300 mm	12



FESTA

TELESCOPIC POLE SAW

 · 3 x sharpened and heat treated teeth

No.	dimensions	
45033	230 - 490 cm 340 mm	1



CATTERPILAR WITH SAW

No.	dimensions	
45030	saw 300 mm telescopic pole 240 cm	6
45031	saw 300 mm	6



CATTERPILAR

No.	dimensions	
45032	metal caterpillar without saw	10



FESTA
MACHETE

TEFLON

No.	dimensions	
45069	440 mm	6



FESTA
MACHETE

TEFLON

No.	dimensions	
44950	490 mm	4



MACHETE STAINLESS STEEL

INOX

No.	dimensions	
45083	430 mm	12
45084	600 mm	6



MACHETE
handle made out of ash wood

No.	dimensions	
45081	510 mm	36
45082	710 mm	36



SHOVEL STAINLESS



No.	dimensions	
45056	360 mm	12



SHOVEL NARROW STAINLESS



No.	dimensions	
45057	350 mm	12



HACK STAINLESS



No.	dimensions	
45058	270 mm	12



HACK STAINLESS



No.	dimensions	
45059	370 mm	12



SHOVEL NYLON



No.	dimensions	
45065	280 mm	1



SHOVEL NARROW NYLON



No.	dimensions	
45066	310 mm	1



FORK NYLON



No.	dimensions	
45067	290 mm	1



TOOLS



4x



No.	dimensions	
45035	240 mm	35



"T" PLANTING DOSSIL

No.	dimensions	
45038	280 mm	60



PLUCKING FOR WEED

No.	dimensions	
44955	950 mm	16



WEED KNIFE

No.	dimensions	
45079	200 mm	1



WEED KNIFE

No.	dimensions	
45080	200 mm „L“	1



FOLDING SHOVEL 3 IN 1

No.	dimensions	
61085	410 mm	6



BULB PLANER

INOX		
No.	dimensions	
45040	230 mm	60



FRUIT PICKER

No.	dimensions	
45041		75



FRUIT PICKER

No.	dimensions	
45039		50
45034	170 - 300 cm, telescopic but	5

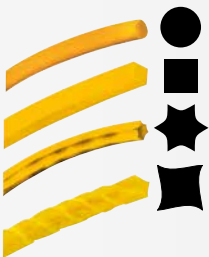

TRIMMER LINES FOW
LAWNMOWER WITH NYLON CENTER



No.		dimensions	
45530	■	2 mm x 15 m	1
45531	■	2,4 mm x 15 m	1
45532	■	3 mm x 15 m	1
45533	■	3,15 mm x 15 m	1
45534	■	4 mm x 15 m	1

TRIMMER LINES FOW LAWN MOVER



No.		dimensions	
45500	●	1,3 mm x 15 m	30
45502	★	1,3 mm x 15 m	30
45503	●	1,6 mm x 15 m	20
45505	★	1,6 mm x 15 m	20
45506	●	2 mm x 15 m	12
45508	★	2 mm x 15 m	12
45517	■	2 mm x 15 m	10
45509	●	2,4 mm x 15 m	12
45511	★	2,4 mm x 15 m	12
45512	■	2,4 mm x 15 m	10
45518	■	2,4 mm x 15 m	10
45523	●	2,7 mm x 15 m	10
45524	★	2,7 mm x 15 m	10
45513	●	3 mm x 15 m	10
45515	■	3 mm x 15 m	10
45516	■	3 mm x 15 m	10
45519	■	3 mm x 15 m	10



TRIMMER LINES FOW LAWN MOVER

No.		dimensions	
45520	●	2 mm x 162 m	10
45521	●	2,4 mm x 112 m	10
45528	●	2,7 mm x 90 m	10
45522	●	3 mm x 72 m	10
45525	★	2 mm x 162 m	10
45526	★	2,4 mm x 112 m	10
45529	★	2,7 mm x 90 m	10
45527	★	3 mm x 72 m	10



WHETSTONE

No.	dimensions	
45046	205 x 15 mm	100



WHETSTONE OVAL

No.	dimensions	
45370	250 x 33 x 18 mm	20

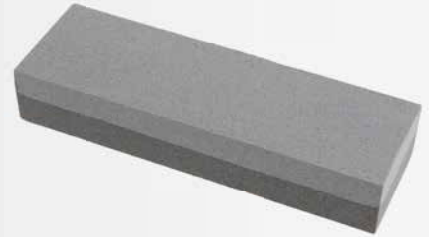

WHETSTONE

No.	dimensions	
45045	150 x 50 x 30 mm	50



SHARPENER FOR KNIVES AND SCISSORS 6 IN 1

No.	dimensions	
45068		10



SHARPENER FOR KNIVES AND SCISSORS

No.	dimensions	
45048		20



SHARPENER FOR KNIVES AND SCISSORS

No.	dimensions	
16990	Ø 50 mm	50



SHARPENER FOR KNIVES AND SCISSORS

No.	dimensions	
16991		20



BINDING TAPE

No.	dimensions	
45472	3 cm x 3 m, 3 ks	36



BINDING TAPE

No.	dimensions	
45473	3 cm x 50 m	60



BINDING TAPE, VELCRO

No.	dimensions	
45471	12 mm x 5 m	1



BINDING WIRE

No.	dimensions	
45043	30 m	30



BINDING WIRE RUBBERCOATING

No.	dimensions	
23845	3 mm x 8 m	30
23846	4 mm x 6 m	30
23847	5 mm x 4 m	30



GARDEN BAR FIBERGLASS

No.	dimensions	
45036	180 cm Ø 7,9 mm	100



BINDING TAPES - TOOTHED

50x

No.	dimensions	
23840		20

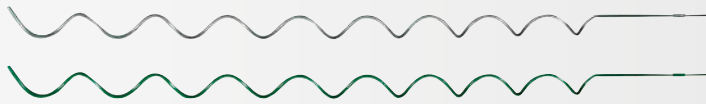

SPIRAL GARDEN BAR

No.	dimensions	
44041	1,2 m, Ø 5,5 mm komaxit - green	10
44042	1,5 m, Ø 6 mm komaxit - green	10
44043	1,8 m, Ø 6 mm komaxit - green	10
45049	1,8 m, Ø 7 mm komaxit - green	10
45044	1,8 m, Ø 7 mm komaxit - silver	10
44050	2,2 m, Ø 7 mm komaxit - green	10



GARDEN BAR FIBERGLASS

No.	dimensions	
45670	8 mm	10
45671	11 mm	10
45672	16 mm	10
45673	20 mm	10

MOQ 10



GARDEN BAR

No.	dimensions		No.	dimensions		No.	dimensions	
45650	90 cm Ø 8 mm	25	45655	150 cm Ø 11 mm	25	45659	180 cm Ø 16 mm	25
45651	120 cm Ø 8 mm	25	45656	180 cm Ø 11 mm	25	45660	210 cm Ø 16 mm	25
45652	150 cm Ø 8 mm	25	45661	210 cm Ø 11 mm	25	45662	150 cm Ø 20 mm	10
45653	90 cm Ø 11 mm	25	45657	120 cm Ø 16 mm	25	45663	180 cm Ø 20 mm	10
45654	120 cm Ø 11 mm	25	45658	150 cm Ø 16 mm	25	45664	210 cm Ø 20 mm	10

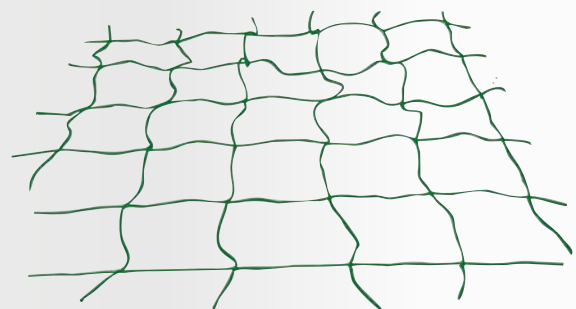

CUCUMBER NET

No.	dimensions	eye size	
45560	2 x 10 m	10 x 10 cm	100

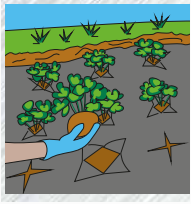

MULCHING FABRIC

MULCHING FABRIC

BONDED WEB FABRIC WITH SECTIONS FOR PLANTS

uv STABLE 45 g/m²

No.	dimensions	
45535	1,6 x 5 m	18

uv STABLE 50 g/m²

No.	dimensions	
45550	1,6 x 5 m	50
45551	1,6 x 10 m	20
45564	3,2 x 10 m	20
45552	1,6 x 50 m	in a role 1
45553	1,6 x 100 m	in a role 1
45562	3,2 x 50 m	in a role 1
45563	3,2 x 100 m	in a role 1

uv STABLE 50 g/m²

No.	dimensions	
45556	1,6 x 5 m	50
45557	1,6 x 10 m	20
45565	3,2 x 10 m	20
45558	1,6 x 50 m	in a role 1
45559	1,6 x 100 m	in a role 1



BONDED WEB FABRIC WHITE

uv STABLE 17 g/m²

No.	dimensions	
45540	1,6 x 5 m	40
45541	1,6 x 10 m	40
45542	1,6 x 50 m	in a role 1
45543	1,6 x 100 m	in a role 1



PIN FOR ATTACHING MULCHING FABRIC

10x

No.	dimensions	
45555	11,5 cm	1



GARDEN FOLDING CHAIR

• for sitting and upside down for kneeling

No.	dimensions	
45074	58 x 48 x 28 cm	4



KNEELER

No.	dimensions	
45086	40 x 18 x 2 cm	50



CULTIVATOR



No.	dimensions	
45042	160 x 132 cm	12

CULTIVATOR



No.	dimensions	
44053		12
61251	160 cm handle	1

SPREADING CART

DIMENSIONS

height:	111 cm
wide:	55 cm
volume:	12 l



No.	dimensions	
45085	12 l	1



BUCKET



No.	dimensions	
39192	30 l	20
39193	45 l	20



FOLDING BASKET FOR LEAVES

No.	dimensions	
45047	55 x 70 cm, 3 handles	20



FOLDING BASKET

No.	dimensions	
45093	40 x 25 x 23 cm	10



FOLDING BASKET FOR LEAVES

No.	dimensions	
44960	200 l 60 x 60 x 55 cm	50

- PROFESSIONAL WATERING ASSORTMENT
- QUALITY MATERIALS AND PROCESSING
- MODERN DESIGN
- COMPATIBLE WITH ROSA PRODUCTS



FESTA
AQUATIC
SPRAY GUN

- 7 functions
- front trigger with lock
- effortless flow control



No. dimensions
45386



12



FESTA
AQUATIC
SPRAY GUN

- adjustable flowing
- front trigger with lock
- effortless flow control



No. dimensions
45388



12



FESTA
AQUATIC
SPRINKLER

- adjustable flowing



No. dimensions
45389



24



FESTA
AQUATIC
HOSE BASIC SET

- adjustable flowing



No. dimensions
45385 4 pcs



12



FESTA
AQUATIC

HOSE CONNECTOR



No. dimensions
45390 24

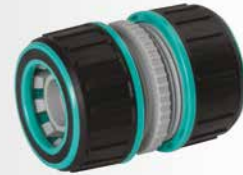

FESTA
AQUATIC

HOSE CONNECTOR



No. dimensions
45391 24



FESTA
AQUATIC

HOSE CONNECTOR



No. dimensions
45392 24



FESTA
AQUATIC

HOSE CONNECTOR



No. dimensions
45393 24



FESTA
AQUATIC

STOP HOSE CONNECTOR



No. dimensions
45394 24



FESTA
AQUATIC

STOP HOSE CONNECTOR



No. dimensions
45395 24



FESTA
AQUATIC

ADAPTOR



No. dimensions
45396 24



FESTA
AQUATIC

ADAPTOR



No. dimensions
45397 24

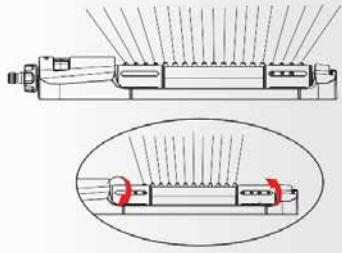

FESTA
AQUATIC
SPRINKLER

· 19 nozzles with 8 switchable (on/off) spray nozzles

2bar min 4bar max	Max 27L/min	318 m ²
----------------------	----------------	--------------------

No. dimensions
45398



6

FESTA
AQUATIC
SPRINKLER

· adjustable arms with nozzles

4bar max	Max 30L/min	360°	R 6m 113m ²
----------	----------------	------	---------------------------

No. dimensions
45399



12

FESTA
AQUATIC
WATER DISTRIBUTOR

· adjustable flow control

3/4"	1"
------	----

No. dimensions
45400



6

FESTA
AQUATIC
WATER DISTRIBUTOR

· adjustable flow control

3/4"	1"
------	----

No. dimensions
45401



6



ROSA
Watering system



ROSA
SPRAY GUN
· 10 functions
· front trigger with lock

0,7 bar min
5,5 bar max



No. dimensions
45124 12



ROSA
SPRAY GUN
· 10 functions
· trigger with lock
· effortless flow control

0,7 bar min
5,5 bar max



No. dimensions
45125 12



ROSA
SPRAY GUN
· 7 functions
· trigger with lock

0,7 bar min
5,5 bar max



No. dimensions
45126 12



ROSA
SPRAY GUN, DELUX
· 7 functions
· trigger with lock
· effortless flow control

0,7 bar min
5,5 bar max



No. dimensions
45123 metal 12



ROSA
SPRAY GUN
· 6 functions
· trigger with lock
· effortless flow control

0,7 bar min
5,5 bar max



No. dimensions
45117 12



ROSA
SPRAY GUN, DELUX
· 6 functions
· trigger with lock
· effortless flow control

0,7 bar min
5,5 bar max



No. dimensions
45118 metal head 12

ROSA
SPRAY GUN

- 5 functions
- trigger with lock
- effortless flow control



No. dimensions
45110



12

ROSA
SPRAY GUN

- rose gun
- effortless flow control



No. dimensions
45116



12

ROSA
SPRAY GUN

- metal head
- trigger with lock
- effortless flow control



No. dimensions
45120



12

ROSA
SPRAY GUN

- trigger with lock
- effortless flow control



No. dimensions
45115



12

ROSA
SPRAY GUN

- metal
- trigger with lock
- effortless flow control



No. dimensions
45122 metal



12

ROSA
SPRAY GUN SET

- trigger with lock
- effortless flow control



2x

No. dimensions
45114 1/2 hose connector



12

ROSA
SPRAY GUN

- trigger with lock
- effortless flow control



No. dimensions
45111



12

ROSA
SPRINKLER

- adjustable flowing



No. dimensions
45113



60

ROSA

SPRINKLER

· stream lined, classic connection



No. dimensions
45112

32

ROSA

SPRAY GUN SET

- 6 functions
- trigger with lock
- effortless flow control



No. dimensions
45181

12

ROSA

SET WITH SPRAY GUN

· adjustable flowing



No. dimensions
45180

12

ROSA

Y - SWITCH COUPLING SWIVEL

· with water valve



No. dimensions
45134

12

ROSA

HOSE MENDER



No. dimensions
45140

60

ROSA

HOSE MENDER



No. dimensions
45296

MOQ 20

ROSA

HOSE CONECTOR



No. dimensions
45142

60

ROSA

HOSE CONECTOR



No. dimensions
45298

MOQ 20



ROSA

STOP HOSE CONECTOR



No. dimensions  60



ROSA

STOP HOSE CONECTOR



No. dimensions  **MOQ 20**  **MOQ 20**



ROSA

HOSE CONECTOR



No. dimensions  60



ROSA

HOSE CONECTOR



No. dimensions  **MOQ 20**  **MOQ 20**



ROSA

HOSE CONECTOR





No. dimensions  60



ROSA

HOSE CONECTOR



No. dimensions  **MOQ 20**  **MOQ 20**



ROSA

STOP HOSE CONECTOR





No. dimensions  60



ROSA

STOP HOSE CONECTOR



No. dimensions  **MOQ 20**  **MOQ 20**



ROSA
ADAPTER



No.	dimensions	
45130	1/2" + 3/4"	60
45131	3/4" + 1"	60



ROSA
ADAPTER



No.	dimensions	
45289	1/2" + 3/4"	MOQ 20
45290	3/4" + 1"	MOQ 20

MOQ 20



ROSA
HOSE CONNECTOR SET



No.	dimensions	
45144		60



ROSA
REDUCTION 1/2" - 3/4"



No.	dimensions	
45213	1/2" - 3/4"	60



ROSA
ONE-WAY SWITCH COUPLING
· with water valve



No.	dimensions	
45135		60



ROSA
ADAPTER



No.	dimensions	
45145		60



ROSA
ADAPTER



No.	dimensions	
45132		60



ROSA
ADAPTER



No.	dimensions	
45291		MOQ 20

MOQ 20





ROSA
ADAPTER



No. dimensions 
45133 60



ROSA
ADAPTER



No. dimensions 
45292 MOQ 20



ROSA
ADAPTER



No. dimensions 
45136 60



ROSA
ADAPTER



No. dimensions 
45293 MOQ 20



ROSA
ADAPTER



No. dimensions 
45137 60

ROSA
ADAPTER



No. dimensions 
45215 48



ROSA
HOSE CONNECTOR



No. dimensions 
45218 48



ROSA
HOSE CONNECTOR



No. dimensions 
45219 48



ROSA
REDUCTION 3/4" - 1"



No. dimensions
45216 48



ROSA
ADAPTER



No. dimensions
45217 48

ROSA
SALES SET

· content of set

- 45113 15 ks
- 45117 10 ks
- 45120 15 ks
- 45132 40 ks
- 45131 40 ks
- 45133 40 ks
- 45142 25 ks
- 45143 20 ks
- 45140 20 ks

225x



No. dimensions
45146 1



ROSA
SPRINKLER
· adjustable flowing



No. dimensions
45214 48

ROSA
SPRINKLER
IMPULS

· impulse



No. dimensions
45162 24



ROSA
SPRINKLER

· function



No. dimensions
45154 48



ROSA
SPRINKLER

· rotary
· 2 arms



No. dimensions
45153 24



ROSA
SPRINKLER

· rotary
· 3 arms



No. dimensions
45152 24





ROSA
SPRINKLER SWINGING

· 17 jets ALU

0,7 bar min
5,5 bar max

ALU



No. dimensions
45158 6



ROSA
SPRINKLER

· pyramidal

0,7 bar min
5,5 bar max



No. dimensions
45167 12



ROSA
SPRINKLER

· point

0,7 bar min
5,5 bar max



No. dimensions
45160 25



ROSA
SPRINKLER

· pot sprinkler with valve

0,7 bar min
5,5 bar max



No. dimensions
45156 12



ROSA
STAND FOR IMPULSE SPRINKLER

0,7 bar min
5,5 bar max

3/4"



No. dimensions
45155 24



ROSA
SPLINKER, IMPULSE

· tripod

0,7 bar min
5,5 bar max



No. dimensions
45163 impulse, tripod 20



ROSA
WATER TIMER

· 0 - 120 min.

0,7 bar min
5,5 bar max

3/4"



No. dimensions
45147 24



ROSA
SPRINKLER, IMPULS

· brass

0,7 bar min
5,5 bar max

3/4"



No. dimensions
45150 12



ROSA
SPRINKLER, IMPULSE

		No.	dimensions	
		45151		12

ROSA
SPRINKLER, IMPULSE, POINT

		No.	dimensions	
		45168	plastový hrot	12
		45169	kovový hrot	12



ROSA
SPRINKLER, IMPULSE, POINT

		No.	dimensions	
		45161	plastový hrot	20

ROSA
SPRINKLER, ROTARY, POINT

		No.	dimensions	
		45164	plastový hrot	12



ROSA
SPIKE STAND

			No.	dimensions	
			45159		12

ROSA
SPIKE STAND

	No.	dimensions	
	45179		12

ROSA
HOSE GUIDE

No.	dimensions	
45186		48

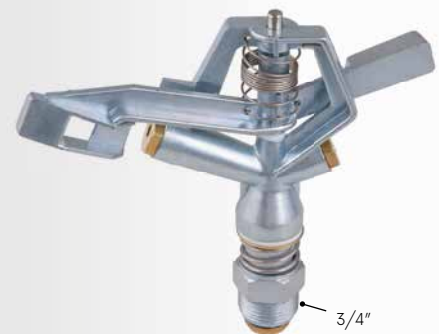

ROSA
SPRINKLER, IMPULS

	No.	dimensions	
	45185		20

ROSA
SPRINKLER, IMPULS

	No.	dimensions	
	45184		20

ROSA

SEL SET

· for items

- 45110, 45111, 45118,
- 45120, 45121, 45123,
- 45125, 45126, 45130,
- 45131, 45132, 45134,
- 45135, 45152, 45153,
- 45154, 45155, 45156,
- 45162, 45177, 45178,
- 45180, 45196, 45197,
- 45198



ROSA

SEALING RING

50x

No.	dimensions	
45175		1

No.	dimensions	
45187		1



ROSA

HOSE REEL

No.	dimensions	
45182	1/2" 40 m	4



ROSA

AUTO REWIND HOSE REEL

· hose included 1/2" 20 m



No.	dimensions	
45176		1



ROSA

HOSE CART METAL

No.	dimensions	
45183	1/2" 60 m	5



ROSA

HOSE CART

No.	dimensions	
45177	1/2" 60 m	5



ROSA

HOSE HOLDER

No.	dimensions	
45178	1/2" 60 m	5



ROSA
SHOWER

0,7bar min
5,5bar max

No.	dimensions	
45171	adjustable	12



ROSA
SHOWER

0,7bar min
5,5bar max

No.	dimensions	
45170	tripod	6



ROSA
HAND SHOVER

0,7bar min
5,5bar max

No.	dimensions	
45172	with valve	12
45173	10 function	12



ROSA
HOSE CARRIER

No.	dimensions	
45174		60



GARDEN HOSE CLEAR

No.	dimensions	
45345	1/2" 25 m	1
45349	3/4" 25 m	1
45353	1" 25 m	1



GARDEN HOSE OPAQUE

No.	dimensions	
45360	1/2" 25 m	1
45364	3/4" 25 m	1
45366	1" 25 m	1



ROSA
SPIRAL HOSE - SET

0,7bar min
5,5bar max

No.	dimensions	
45300	7,5 m	6
45301	15 m	8



HOSE CARRIER

No.	dimensions	
45350	Max. holding capacity 20 kg	1



ROSA
HOSE MENDER BRASS

No.	dimensions	
45192		48



ROSA
HOSE CONNECTOR BRASS

No.	dimensions	
45194		48



ROSA
STOP HOSE CONNECTOR BRASS

No.	dimensions	
45190		48



ROSA
HOSE MENDER BRASS

No.	dimensions	
45193		48



ROSA
HOSE CONNECTOR BRASS

No.	dimensions	
45195		48



ROSA
STOP HOSE CONNECTOR BRASS

No.	dimensions	
45191		48



ROSA
ADAPTER BRASS

No.	dimensions		
45196	with inward scroll 1/2" + 3/4"		48



ROSA
ADAPTER BRASS

No.	dimensions	
45197	with inward scroll 3/4"	48



ROSA
ADAPTER BRASS

No.	dimensions	
45199	with inward scroll 1"	48



ROSA
ADAPTER BRASS

No.	dimensions		
45198	with inward scroll 3/4 + 1"		48



ROSA
ADAPTER BRASS

No.	dimensions	
45200	with outward scroll 3/4"	48



ROSA
ADAPTER BRASS

No.	dimensions
45206	adjustable



ROSA

ADAPTER BRASS



No.	dimensions	
45203	connection for 2 hose connectors	48



ROSA

ADAPTER BRASS



No.	dimensions	
45204	connection for 3 hose connectors	48



HOSE ADAPTER WITH BRASS THREAD



No.	dimensions	
45211	inner thread 1"	25



HOSE MENDER

C.p.	specifikace	
45220	1/2" thread 3/4"	10
45221	3/4" thread 1"	10
45222	1" thread 1"	10



HOSE END

C.p.	specifikace	
45223	1/2" thread 3/4"	10
45224	3/4" thread 1"	10
45225	1" thread 1"	10



HOSE REDUCTION

No.	dimensions	
45226	1/2" - 3/4" thread 1"	10
45227	1" - 3/4" thread 1"	10
45228	1" - 1/2" thread 1"	10



SPRINKLER

No.	dimensions	
45229		10



HOSE CLAMP

Zn		MOQ
No.	diameter	
45600	8 - 12 mm	2
45601	10 - 16 mm	2
45602	12 - 20 mm	2

No.	diameter	
45603	16 - 25 mm	2
45604	20 - 32 mm	2
45605	25 - 40 mm	2
45606	30 - 45 mm	2
45607	32 - 50 mm	2
45608	40 - 60 mm	2
45609	50 - 70 mm	2
45610	60 - 80 mm	2
45611	70 - 90 mm	2
45612	80 - 100 mm	2
45613	90 - 110 mm	2
45614	100 - 120 mm	2
45615	110 - 130 mm	2
45616	120 - 140 mm	2
45617	130 - 150 mm	2
45618	140 - 160 mm	2
45619	150 - 170 mm	2



HOSE CLAMP

INOX		MOQ	
No.	diameter	width	
45620	8 - 12 mm	9 mm	2
45621	10 - 16 mm	9 mm	2
45622	12 - 20 mm	9 mm	2

No.	diameter	width	
45623	16 - 25 mm	9 mm	2
45624	20 - 32 mm	9 mm	2
45625	25 - 40 mm	12 mm	2
45626	30 - 45 mm	12 mm	2
45627	32 - 50 mm	12 mm	2
45628	40 - 60 mm	12 mm	2
45629	50 - 70 mm	12 mm	2
45630	60 - 80 mm	12 mm	2
45631	70 - 90 mm	12 mm	2
45632	80 - 100 mm	12 mm	2
45633	90 - 110 mm	12 mm	2
45634	100 - 120 mm	12 mm	2
45635	110 - 130 mm	12 mm	2
45636	120 - 140 mm	12 mm	2
45637	130 - 150 mm	12 mm	2
45638	140 - 160 mm	12 mm	2
45639	150 - 170 mm	12 mm	2



GARDEN VALVES AND GARDEN EWERS



DOUBLE WATER VALVE

No.	dimensions	
45105		8



GARDEN VALVE

No.	dimensions	
45100	1/2"	12
45101	3/4"	10
45102	1"	6

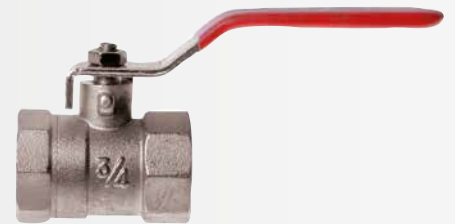

BALL VALVE

No.	dimensions	
45106	1/2"	12
45107	3/4"	10
45108	1"	8



CORNER VALVE

No.	dimensions	
45104	1/2" x 3/8"	10



WATERING CAN PLASTIC



No.	dimensions	
45280	2,5 l	10
45283	5 l	10
45285	10 l	10
45286	12 l	10
45287	15 l	10



FESTA

PRESSURE SPRAYER 12 L

max. pressure:	2,5 Bar
volume:	12 l
length of hose	3 m
dimensions:	32 x 25 x 59 cm

No.	dimensions	
45249	pressure sprayer 12 l	1
45273	spare nozzle	1
45274	spare pressure hose	1

FESTA

HIGH PRESSURE CLEANER

voltage frequency :	230 V/50 Hz
power consumption :	1500 W
max. pressure :	120 Bar
work pressure :	80 Bar
flow of water :	6 l
length of hose :	5 m
protection :	IPX5
function :	Auto Stop



No.	dimensions	
45270	high pressure cleaner	1
45271	spare nozzle	1
45272	spare pressure hose	1



FESTA

PRESSURE SPRAYER

No.	dimensions	
45247	12 l	1
45248	16 l	1

No.	dimensions	
45263	spare hose	1
45251	spare set of selling	1
45254	spare nozzle	1
45257	spare handle	1
45260	spare pole - 370 mm	1
45267	spare pole 45 - 250 cm	1
45268	spare pole 65 - 260 cm	1



FESTA

PRESSURE SPRAYER

No.	dimensions	
45244	3 l	6
45245	5 l	6
45246	8 l	6

No.	dimensions	
45262	spare hose	1
45250	spare set of selling	1
45253	spare nozzle	1
45256	spare handle	1
45261	spare pole - 370 mm	1



PRESSURE HAND SPRAYER

No.	typ	
45242	1,5 l	20
45241	2 l	20



HAND SPRAYER



No.	typ	
45239	0,5 l	1
45240	0,7 l	1



TELESCOPIC POLE FOR PRESSURE SPRAYER

No.	typ		
45267	45 - 250 cm	inox	1
45268	65 - 260 cm	fiberglass	1

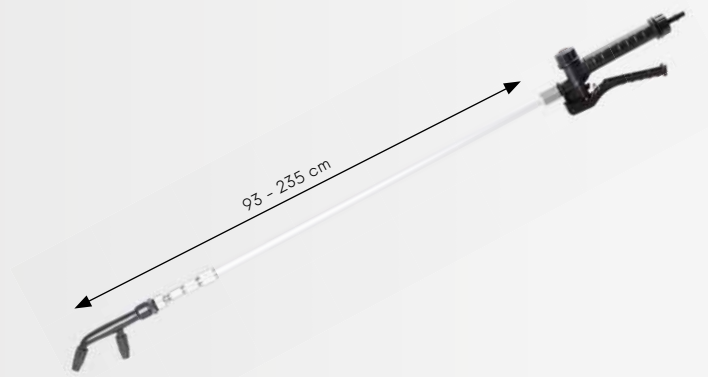

TELESCOPIC SPRINKLER

No.	dimensions	
45269		1



SPARE HOSE FOR PRESSURE SPRAYER

No.	typ	
45263	for sprayer 45247, 45248	1
45262	for sprayer 45244, 45245, 45246	1



HERBICID BELL

No.	dimensions	length	width	height	
45265	small	230 mm	90 mm	130 mm	1
45266	big	370 mm	140 mm	200 mm	1

FESTA[®]



RAKES



FESTA

PLASTIC RAKE

No.	no. lamellas	width	height	
45327	13	240 mm	200 mm	12

system click
ON - OFF



FESTA

SET PLASTIC RAKE,
ALUMINIUM HANDLE

MOQ
3

No.	no. lamellas	shaft length	
61136	13	160 cm	3
61147	13	100 cm	3



FESTA

PLASTIC RAKE

No.	no. lamellas	width	height	
45328	23	480 mm	280 mm	12

system click
ON - OFF



FESTA

SET PLASTIC RAKE,
ALUMINIUM HANDLE

MOQ
3

No.	no. lamellas	shaft length	
61137	23	160 cm	3
61148	23	100 cm	3



FESTA

PLASTIC RAKE

No.	no. lamellas	width	height	
45329	35	760 mm	310 mm	1

system click
ON - OFF



FESTA

SET PLASTIC RAKE,
ALUMINIUM HANDLE

MOQ
3

No.	no. lamellas	shaft length	
61138	35	160 cm	3



FESTA
PLASTIC RAKE

No.	no. lamellas	width	
45325	12	410 mm	12



FESTA
SET PLASTIC RAKE,
ALUMINIUM HANDLE

MOQ
3

No.	no. lamellas	shaft length	
61139	12	160 cm	3



FESTA
PLASTIC RAKE

No.	no. lamellas	width	
45326	18	580 mm	12



FESTA
SET PLASTIC RAKE,
ALUMINIUM HANDLE

MOQ
3

No.	no. lamellas	shaft length	
61140	18	160 cm	3



BRUSH

No.	dimensions	
45323	37 cm	16



SET BRUSH, ALU HANDLE

MOQ
3

No.	dimensions	shaft length	
61149	37 cm	160 cm (45330)	3



FESTA
METAL RAKE ADJUSTABLE, TELESCOPIC

No.	no. lamellas	rozsah	
44965	15	200 - 590 mm	12



METAL RAKE ADJUSTABLE

No.	no. lamellas	váha	rozsah	
45050	15	1200 g	200 - 590 mm	25



FESTA

METAL RAKE

· spring steel

No.	width	no. lamellas	
45071	55 cm	22	1



FESTA

METAL RAKE WITH HANDLE

MOQ
3

No.	width	shaft length	
61150	55 cm	160 cm	3



METAL RAKE

No.	width	no. lamellas	
45051	40 cm	22	60



METAL RAKE WITH HANDLE

MOQ
3

No.	width	shaft length	
61130	40 cm	160 cm	3



METAL RAKE - WIRE

No.	width	no. lamellas	
45052	45 cm	22	36



METAL RAKE WITH HANDLE

MOQ
3

No.	width	shaft length	
61131	45 cm	160 cm	3



PLASTIC RAKE



No.	width	no. lamellas	
45320	60 cm	24	10



PLASTIC RAKE WITH HANDLE



MOQ
3

No.	width	no. lamellas	shaft length	
61132	60 cm	24	160 cm	3



PLASTIC RAKE



No.	width	no. lamellas	
45055	50 cm	22	10



PLASTIC RAKE WITH HANDLE



MOQ
3

No.	width	no. lamellas	shaft length	
61133	50 cm	22	160 cm	3



PLASTIC RAKE



No.	width	no. lamellas	
45321	40 cm	23	20



PLASTIC RAKE WITH HANDLE



No.	no. lamellas	shaft length	MOQ
61134	23	160 cm	3



PLASTIC RAKE



No.	width	no. lamellas	
45054	40 cm	23	10



PLASTIC RAKE WITH HANDLE



No.	width	no. lamellas	shaft length	MOQ
61135	40 cm	23	160 cm	3



PLASTIC RAKE



No.	width	no. lamellas	
45053	58 cm	16	35



PLASTIC RAKE WITH HANDLE



No.	width	no. lamellas	shaft length	MOQ
61141	58 cm	16	160 cm	3



PLASTIC RAKE WITH ALIGNMENT EDGE



No.	width	no. teeth	
45070	41 cm	14	4



PLASTIC RAKE WITH HANDLE ALIGNMENT EDGE



No.	width	no. teeth	shaft length	MOQ
61142	41 cm	14	160 cm	3



METAL RAKE

No.	width	no. teeth	
61030	24 cm	10	24
61031	29 cm	12	24
61032	34 cm	14	24
61033	40 cm	16	24



METAL RAKE WITH HANDLE

MOQ
3

No.	width	no. teeth	shaft length	
61060	24 cm	10	160 cm	3
61061	29 cm	12	160 cm	3
61062	34 cm	14	160 cm	3
61063	40 cm	16	160 cm	3



RAKE VERTICUTATION METAL

· hammer point

No.	width	no. teeth	
61045	30 cm	12	25
61046	39 cm	14	25
61047	45 cm	16	25



RAKE WITH WOODEN HANDLE

· hammer point

MOQ
3

No.	width	no. teeth	shaft length	
61143	30 cm	12	160 cm	3
61144	39 cm	14	160 cm	3
61145	45 cm	16	160 cm	3



RAKE ARETATION

No.	width	no. teeth	
61048	35 cm	11 21	12



RAKE ARETATION WITH HANDLE

MOQ
3

No.	width	no. teeth	shaft length	
61146	35 cm	11 21	160 cm	3



METAL RAKE WITH HANDLE FIBERGLASS

MOQ
3

No.	width	no. teeth	shaft length	
61034	34 cm	14	160 cm	3



FESTA[®]

SPADES AND SHOVELS



FESTA

SPADE POINTED SMALL

• suitable for work in the greenhouse

No.	dimensions	shaft length	
61008	19 x 28 cm	85 cm	5



FESTA

SPADE ROUND

No.	dimensions	shaft length	
61005	20 x 29 cm	120 cm	5



FESTA

SPADE POINTED

No.	dimensions	shaft length	
61006	19 x 28 cm	120 cm	5



FESTA

SPADE ROUND, EXTENDED

• for persone higher than 180 cm

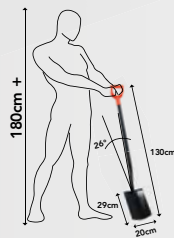

No.	dimensions	shaft length	
61157	20 x 29 cm	130 cm	5



FESTA

SPADE POINTED, EXTENDED

• for persone higher than 180 cm

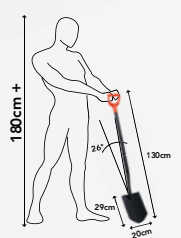

No.	dimensions	shaft length	
61158	19 x 28 cm	130 cm	5



FESTA

SHOVEL STANDARD

No.	dimensions	shaft length	
61155	24 x 29 cm	120 cm	5



FESTA

FORK

No.	dimensions	shaft length	
61156	19 x 28 cm	130 cm	5



FESTA

FORK

No.	dimensions	shaft length	
61007	18 x 28 cm	130 cm	5



FORK, FIBERGLASS HANDLE

No.	dimensions	shaft length	
61010	18 x 30 cm	95 cm	12



SPADE POINTED, FIBERGLASS HANDLE

No.	dimensions	shaft length	
61029	19 x 30 cm	95 cm	12



SPADE, FIBERGLASS HANDLE

No.	dimensions	shaft length	
61015	19 x 30 cm	95 cm	12



SHOVEL COAL



No.	dimensions	
61026	26 x 29 cm	10
61025	34 x 30 cm	10



ALU SHOVEL WITH HANDLE

· beech handle with knuckle



MOQ
3

No.	dimensions	shaft length	
61057	26 x 29 cm	130 cm	3
61056	34 x 30 cm	130 cm	3



SHOVEL COAL

No.	dimensions	
61021	35 x 35 cm	10



SHOVEL COAL WITH HANDLE

MOQ
3

No.	dimensions	shaft length	
61089	35 x 35 cm	130 cm	3



ROUND SHOVEL WITH HANDLE

- hammer paint
- beech handle with knuckle

MOQ
3

No.	dimensions	shaft length	
61050	26 x 28 cm	130 cm	3

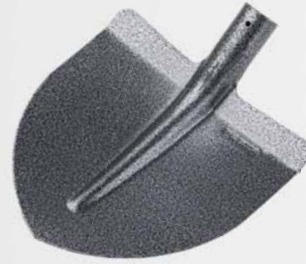

ROUND SHOVEL

- hammer paint

No.	dimensions	
61000	26 x 28 cm	12



ROUND SHOVEL WITH HANDLE

- beech handle with knuckle

MOQ
3

No.	dimensions	shaft length	
61088	26 x 28 cm	130 cm	3



ROUND SHOVEL

No.	dimensions	
61020	26 x 28 cm	12



SHOVEL WITH HANDLE

- hammer paint
- beech handle with knuckle

MOQ
3

No.	dimensions	shaft length	
61051	24 x 29 cm	130 cm	3



SHOVEL

- hammer paint

No.	dimensions	
61001	24 x 29 cm	12



SHOVEL WITH HANDLE

- beech handle with knuckle

MOQ
3

No.	dimensions	shaft length	
61090	24 x 29 cm	130 cm	3
61053	24 x 29 cm	130 cm "T _n " handle	3



SHOVEL

No.	dimensions	
61022	24 x 29 cm	12





SHOVEL

No.	dimensions	
61058	25 x 27 cm	12



SHOVEL WITH HANDLE

· beech handle with knuckle

MOQ
3

No.	dimensions	shaft length	
61059	25 x 27 cm	130 cm	3



NARROW SHOVEL

· hammer paint

No.	dimensions	
61002	19 x 27 cm	12



NARROW SHOVEL WITH HANDLE

· hammer paint
· beech handle with knuckle

MOQ
3

No.	dimensions	shaft length	
61052	19 x 27 cm	130 cm	3



NARROW SHOVEL

No.	dimensions	
61024	19 x 27 cm	12



NARROW SHOVEL WITH HANDLE

· beech handle with knuckle

MOQ
3

No.	dimensions	shaft length	
61054	19 x 27 cm	130 cm	3



SPADE POINTED

· hammer paint

No.	dimensions	
61004	22 x 30 cm	12



SPADE POINTED WITH "T" HANDLE

· hammer paint

MOQ
3

No.	dimensions	shaft length	
61161	22 x 30 cm	90 cm	3



SPADE POINTED WITH "T" HANDLE

MOQ
3

No.	dimensions	shaft length	
61097	19 x 30 cm	90 cm	3



SPADE POINTED

No.	dimensions	
61019	22 x 30 cm	12



DROP FORGED SPADE POINTED WITH "T" HANDLE

MOQ
3

No.	dimensions	shaft length	
61162	22 x 25 cm	90 cm	3
61223	handle	90 cm	1



DROP FORGED SPADE POINTED

No.	dimensions	
61013	22 x 25 cm	12



ROUND SPADE WITH "T" HANDLE

· hammer paint

MOQ
3

No.	dimensions	shaft length	
61163	21 x 30 cm	90 cm	3



SPADE ROUND

· hammer paint

No.	dimensions	
61003	21 x 30 cm	12



ROUND SPADE WITH "T" HANDLE

MOQ
3

No.	dimensions	shaft length	
61098	21 x 30 cm	90 cm	3



SPADE ROUND

No.	dimensions	
61018	21 x 30 cm	12





SPADE

No.	dimensions	MOQ
61014	14 x 37 cm	12



SPADE WITH "T" HANDLE

No.	dimensions	shaft length	MOQ
61164	14 x 37 cm	90 cm	3
61203	handle	90 cm	1



FORK

No.	dimensions	MOQ
61009	20 x 32 cm	12



FORK WITH HANDLE

No.	dimensions	shaft length	MOQ
61165	20 x 32 cm	90 cm	3

• beech handle with knuckle



DROP FORGED FORK

No.	dimensions	MOQ
61012	22 x 30 cm	12



DROP FORGED FORK WITH "T" HANDLE

No.	dimensions	shaft length	MOQ
61166	22 x 30 cm	90 cm	3
61222	handle	90 cm	1



FORK

No.	dimensions	MOQ
61044	20 x 30 cm	12



FORK WITH "T" HANDLE

No.	dimensions	shaft length	MOQ
61028	20 x 30 cm	90 cm	3
61209	handle	90 cm	1



DROP FORGET HOE WITH HANDLE

No.	dimensions	shaft length	MOQ	
61111	0,4 kg	120 cm	3	
61112	0,6 kg	120 cm	3	
61224	handle	120 cm	1	

DROP FORGET HOE

No.	dimensions	A	B	MOQ	
61035	0,4 kg	180 mm	125 mm	1	
61036	0,6 kg	230 mm	160 mm	30	

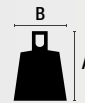

DROP FORGET HOE WITH HANDLE

No.	dimensions	shaft length	MOQ	
61114	0,6 kg	120 cm	3	
61224	handle	120 cm	1	

DROP FORGET HOE

No.	dimensions	A	B	MOQ	
61038	0,6 kg	165 mm	135 mm	20	



MOQ
3



PICKAXE WITH HANDLE

No.	dimensions	shaft length	MOQ	
61121	1,5 kg	95 cm	3	
61042	2,5 kg	95 cm	3	

PICKAXE

No.	dimensions	MOQ	
61120	1,5 kg	6	
61040	2,5 kg	6	





HOE

No.	dimensions		
61067	75 mm	1	
61068	125 mm	1	
61069	175 mm	1	



HOE WITH HANDLE

MOQ
3

No.	dimensions	shaft length	
61290	75 mm	120 cm	3
61291	125 mm	120 cm	3
61292	175 mm	120 cm	3



HOE

No.	dimensions		
61070	140 mm	40	



HOE WITH HANDLE

MOQ
3

No.	dimensions	shaft length	
61293	140 mm	120 cm	3



HOE WITH HANDLE

No.	dimensions	shaft length	
61294	140 mm	27 cm	MOQ 3
61221	handle	27 cm	1



HOE WITH HANDLE

No.	dimensions	shaft length	
61295	140 mm	27 cm	MOQ 3
61221	handle	27 cm	1



HOE WITH HANDLE

No.	dimensions	shaft length	
61296	175 mm	27 cm	MOQ 3
61221	handle	27 cm	1



HOE WITH HANDLE

No.	dimensions	shaft length	
61297		27 cm	MOQ 3
61221	handle	27 cm	1



• illustration photo

STAND FOR SHOVEL AND SPADE

No.	dimensions	
61077	stand with shovels, spades	1
61079	stand with pallet	1



• illustration photo

HOLDER FOR GARDENING TOOLS

No.	dimensions	
51185	45 cm	15



rotating rubber rollers

HOLDER FOR GARDENING TOOLS

No.	dimensions	
51184		12

5x



SICKLE

No.	dimensions	
45490	450 mm	1



FESTA
STEEL BRUSH

No.	dimensions		
22135	6 x 19 cm	without handle	8
22137	6 x 19 cm	with handle 140 cm	MOQ 3



FESTA
NYLON BRUSH

No.	dimensions		
22136	6 x 19 cm	without handle	8
22138	6 x 19 cm	with handle 140 cm	MOQ 3



STEEL BRUSH WITH HANDLE

No.	shaft length	
52198	140 cm	1



BRUSH
MADE IN EU

No.	dimensions	
52119	29 cm	24



BRUSH WITH SHOVEL

No.	dimensions	
52168		26



BRUSH WITH SHOVEL

No.	dimensions	
52173		26



FESTA
STEEL SHOVEL - THICK

No.	dimensions	
52176	22 x 23 cm	24



STEEL SHOVEL

No.	dimensions	
52175	22 x 23 cm	50

BRUSH WITH HANDLE



No.	dimensions	MOQ
52197	30 cm 120 cm wooden	3



BRUSH



No.	dimensions	MOQ
52108	30 cm thread	25
61172	handle 20 cm thread	1



SET BRUSH, ALU HANDLE

No.	dimensions	shaft length	MOQ
61149	37 cm	160 cm	3



BRUSH

No.	dimensions	MOQ
45323	37 cm	16



BRUSH WITH HANDLE



No.	dimensions	shaft length	MOQ
52190	30 cm	150 cm	3
52191	40 cm	150 cm	3
52192	50 cm	150 cm	3
52193	60 cm	150 cm	3
52194	80 cm	150 cm	3



BRUSH



No.	dimensions	MOQ
52101	30 cm	10
52102	40 cm	10
52103	50 cm	10
52104	60 cm	10
52105	80 cm	10



BRUSH WITH HANDLE



No.	dimensions	shaft length	MOQ
52185	40 cm	150 cm	3
52186	50 cm	150 cm	3
52187	60 cm	150 cm	3
52188	70 cm	150 cm	3
52189	80 cm	150 cm	3



BRUSH



No.	dimensions	MOQ
52160	40 cm	10
52161	50 cm	10
52162	60 cm	10
52163	70 cm	10
52164	80 cm	10





BRUSH



No.	dimensions		
52114	28 cm	thread	1



BRUSH WITH HANDLE



No.	dimensions	shaft length	
52116	28 cm	with handle 130 cm	3



BRUSH



No.	dimensions		
52113	30 cm	thread	26
52115	30 cm	without thread	26



BRUSH WITH HANDLE



No.	dimensions		
52195	30 cm	150 cm woody	3
52196	30 cm	130 cm ALU	3



MASON STAFF - RUBBER

No.	dimensions		
15886	450 mm	handle Ø 23 mm	48
15887	600 mm	handle Ø 23 mm	48
15888	750 mm	handle Ø 23 mm	32

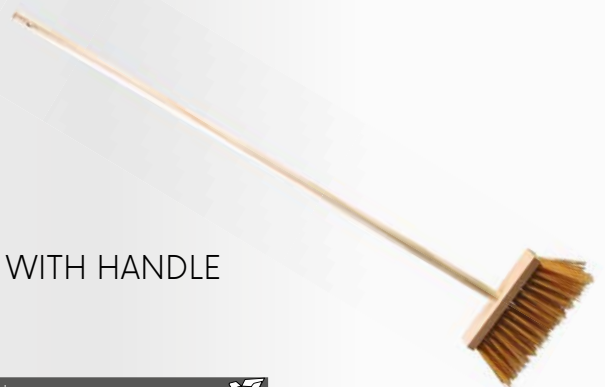

BRUSH WITH HANDLE



No.	dimensions		
52109	25 cm	120 cm woody	12

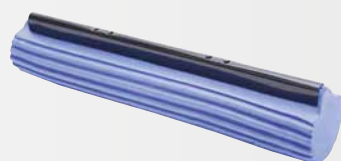

SPARE MOP

No.	dimensions		
52111	30 cm		1



CLEANING MOP

No.	dimensions		
52110	30 cm		16



SNOW SHOVELS



FESTA

SNOW SHOVEL

No.	dimensions	
60006	46 x 34 cm	12
60206	46 x 34 cm, assembled	1



FESTA

SNOW SHOVEL

No.	dimensions	
60008	50 x 34 cm	12
60208	50 x 34 cm, assembled	1



SNOW SHOVEL



No.	dimensions	
60001	48 x 40 cm	10
60201	48 x 40 cm, assembled	1



SNOW SHOVEL

ALU

No.	dimensions	
60012	50 x 38 cm	12
60212	50 x 38 cm, assembled	1



ICE SCRAPER

MOQ
3

No.	dimensions	
60022	20 cm	3

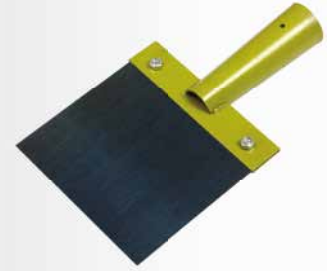

ICE SCRAPER

No.	dimensions	
60018	15 cm	20
60019	20 cm	24
60020	30 cm	20
61201	handle 130 cm	10



ROAD SALT

No.	dimensions	
43300	10 kg	1
43301	25 kg	1



BRUSH HANDLE



No.	dimensions	
61172	120 cm wooden handle with thread	1
61192	150 cm wooden handle	pro 52195 1
61193	150 cm wooden handle	pro 52185 - 94 1
61194	140 cm wooden handle with thread	1



BRUSH HANDLE



No.	dimensions		No.	dimensions	
61171	1,2 m	1	61175	1,6 m	1
61173	1,4 m	1	61176	1,7 m	1
61174	1,5 m	1	61177	1,8 m	1

BRUSH HANDLE



No.	dimensions	
52125	130 cm, fine thread	1
52126	130 cm, thread	1



HANDLE FOR FORK AND SHOVEL



No.	dimensions	
61200	130 cm	10



system click
ON - OFF

HANDLE



No.	dimensions	
45330	161 cm	24
45331	100 cm	24



HANDLE FOR SHOVEL



No.	dimensions	
61201	130 cm, equal	10



HANDLE FOR SHOVEL "T,"



No.	dimensions	
61208	90 cm	10



HANDLE FOR SHOVEL "T,"



No.	dimensions	
61202	130 cm, equal	10



HANDLE FOR MASON DIPPER



No.	dimensions	
61215	160 cm	10



HANDLE FOR SPADE



No.	dimensions	
61207	100 cm	10



HANDLE FOR PICKAXE



No.	dimensions	
61204	95 cm, narrow (for 61120)	10
61205	95 cm	10



HANDLE FOR HOE



No.	dimensions	
61219	120 cm	10



HANDLE FOR PLASTIC RAKE



No.	dimensions	
61195	120 cm	10



HANDLE FOR STEEL RAKE



No.	dimensions	
61183	150 cm	10
61184	160 cm	10
61189	170 cm	10
61190	180 cm	10



HANDLE FOR RAKE



No.	dimensions	suitable for	
61250	160 cm	45051, 61048	20
61251	160 cm	45052	20
61252	160 cm	45320	20
61253	160 cm	45053	20
61254	160 cm	45054	20
61255	160 cm	45070	20
61256	160 cm	45055	20



PLASTIC HANDLE "Y,"



No.	dimensions	
61230		10

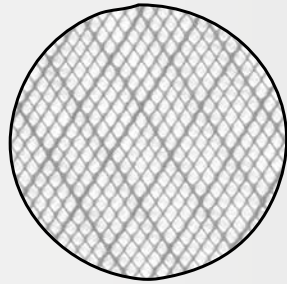

INSECT SCREENS

No.	dimensions	
40100	1 x 25 m - PE white	1
40120	1,2 x 25 m - PE white	1

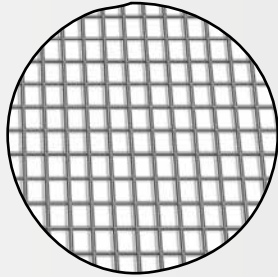

INSECT SCREENS

ALU Zn

No.	dimensions	
42101	1 x 30 m - ALUMINIUM	2
42103	1 x 30 m - galvanized wire	2

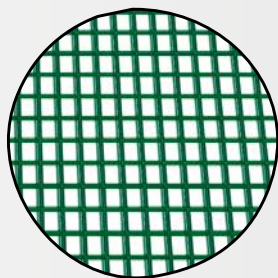

INSECT SCREENS

No.	dimensions	
42102	1x30 m - green coated steel wire	2

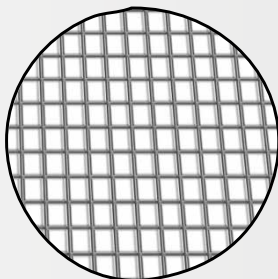

FIBERGLASS INSECT SCREENS

No.	dimensions		
41083	0,8 x 30 m	white	6
41103	1 x 30 m	white	6
41123	1,2 x 30 m	white	6
41153	1,5 x 30 m	white	6

No.	dimensions		
41082	0,8 x 30 m	white-grey	6
41102	1 x 30 m	white-grey	6
41122	1,2 x 30 m	white-grey	6
41152	1,5 x 30 m	white-grey	6

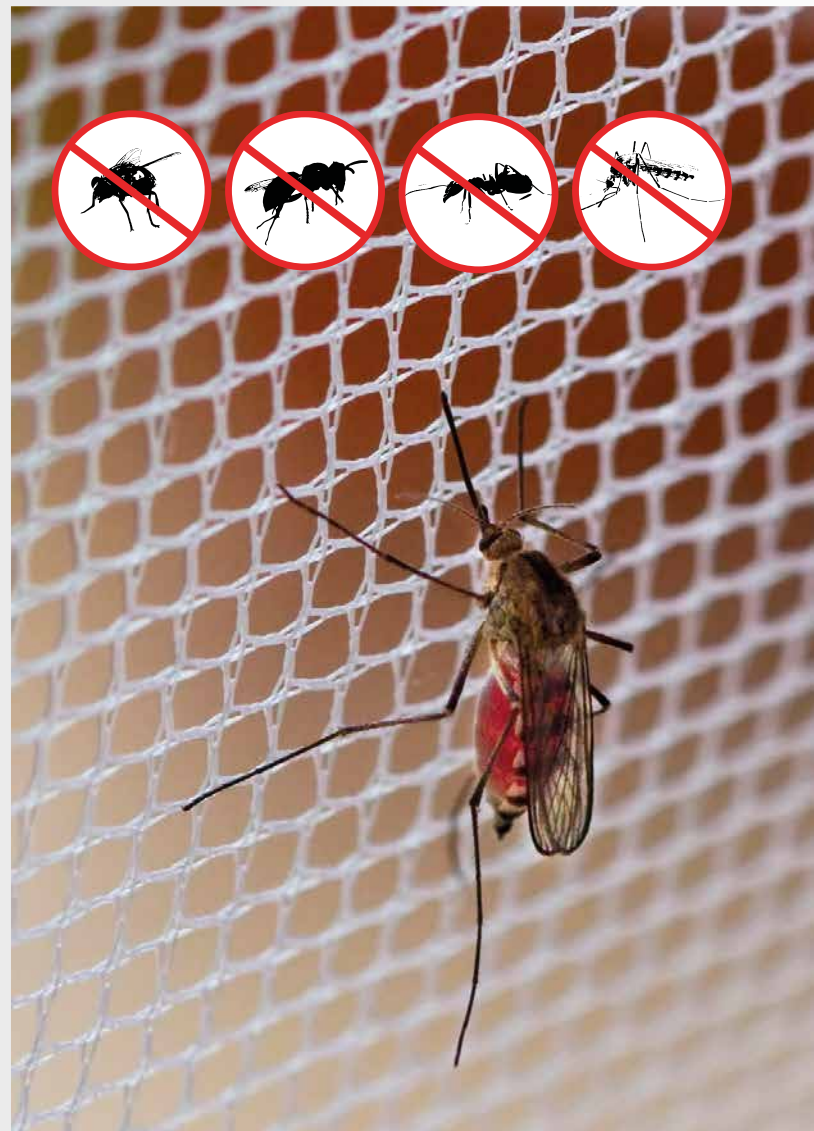

INSECT SCREENS

No.	dimensions		
41050	0,5 x 30 m	grey	6
41080	0,8 x 30 m	grey	6
41100	1 x 30 m	grey	6
41120	1,2 x 30 m	grey	6
41150	1,5 x 30 m	grey	6

No.	dimensions		
41081	0,8 x 30 m	black	6
41101	1 x 30 m	black	6
41121	1,2 x 30 m	black	6
41151	1,5 x 30 m	black	6

NEW

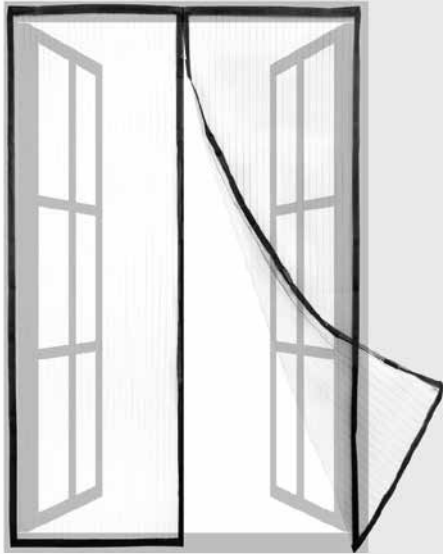

DOOR CURTAIN AGAINST INSECTS
MAGNETIC, ANTHRACITE



No.	dimensions	1
40077	100 x 220 cm	1



CURTAIN AGAINST INSECT

variable size 60 - 120 cm

No.	dimensions		20
40075	4 x 35 x 220 cm	white	20
40076	4 x 35 x 220 cm	black	20



WINDOW NET - WHITE



No.	dimensions		10
40050	150 x 130 cm	5,6 m	10
40052	150 x 180 cm	6,6 m	10
40054	150 x 90 cm	4,8 m	10
40056	220 x 75 cm 2 pcs	5,8 m	10



WINDOW NET - GREY



No.	dimensions		10
40051	150 x 130 cm	5,6 m	10
40053	150 x 180 cm	6,6 m	10
40055	150 x 90 cm	4,8 m	10



WINDOW NET - BLACK



No.	dimensions		10
40057	150 x 130 cm	5,6 m	10
40058	150 x 180 cm	6,6 m	10
40059	150 x 90 cm	4,8 m	10



BURBAND SELF ADHEZIVE FOR WINDOW NET

No.	dimensions	1
40060	9 mm 7 m	1



FENCING HEX

galvanized before entanglement

Zn

No.	dimensions	
42150	13 0,7 x 1000 mm - 50 m	1
42151	16 0,7 x 1000 mm - 50 m	1
42152	20 0,7 x 1000 mm - 50 m	1
42153	25 0,8 x 1000 mm - 50 m	1

Zn

FENCING HEX PVC COATED

Zn

No.	dimensions	
42155	13 0,7 x 1000 mm - 50 m	1
42156	16 0,7 x 1000 mm - 50 m	1
42157	20 0,7 x 1000 mm - 50 m	1
42158	25 0,8 x 1000 mm - 50 m	1

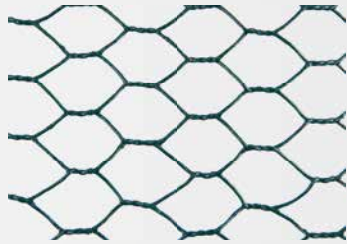

FENCING RECTANGULAR

Zn

No.	dimensions	
42160	13 1 x 1000 mm - 25 m	1
42161	16 1 x 1000 mm - 25 m	1
42162	20 1 x 1000 mm - 25 m	1
42163	25 1 x 1000 mm - 25 m	1

FENCING RECTANGULAR PVC COATED

No.	size	Ø of wire	height	length	
42175	15 x 9 mm	2 mm	40 cm	25 m	1
42176	15 x 9 mm	2 mm	65 cm	25 m	1
42177	15 x 9 mm	2 mm	90 cm	25 m	1
42178	15 x 9 mm	2 mm	120 cm	25 m	1
42179	15 x 9 mm	2 mm	25 cm	25 m	1

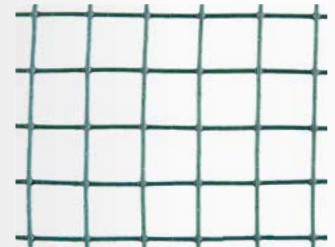
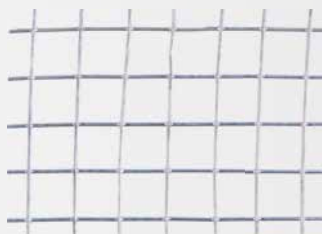

SAFETY MESH FENCING

140 g/m² UV STABLE

No.	dimensions		No.	dimensions	
42185	6 0,65 x 1000 mm - 25 m	1	42174	25 1,4 x 1000 mm - 25 m	1
42170	10 0,8 x 1000 mm - 25 m	1	42186	13 1,05 x 1000 mm - 25 m	1
42171	13 0,8 x 1000 mm - 25 m	1	42187	25 2,0 x 1000 mm - 25 m	1
42172	16 1,2 x 1000 mm - 25 m	1	42188	50 2,0 x 1000 mm - 25 m	1
42173	19 1,4 x 1000 mm - 25 m	1			

GARDEN FENC PVC COATED

No.	dimensions	
42180	13 1,2 x 1000 mm - 25 m	1
42181	16 1,2 x 1000 mm - 25 m	1
42182	25 2,3 x 1000 mm - 25 m	1

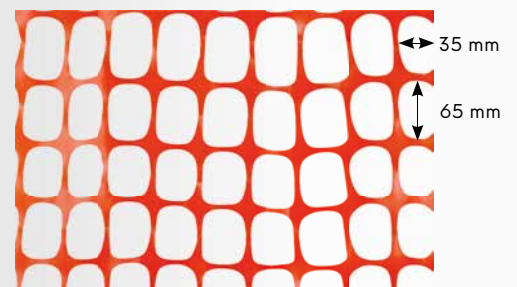

NET AGAINST BIRDS

MADE IN EU

No.	dimensions	
45570	2 x 5 m 18 x 18 mm	45
45571	2 x 10 m 18 x 18 mm	28
45572	4 x 5 m 18 x 18 mm	24
45573	4 x 10 m 18 x 18 mm	15

SAFETY MESH FENCING

140 g/m² UV STABLE

No.	dimensions	
42190	1,2 x 50 m HDPE 140g/m ²	1

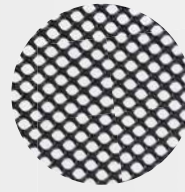

FENCING FABRIC



No.	dimensions	
42312	1 m 50 bm, 16 x 16 mm	1

FENCING AGAINST BROWSING

self-locking



No.	dimensions	
45580	Ø 11 x 80 cm	1



WIRE



No.	Ø of wire	length of wire	
42203	0,6 mm	30 m	50

WIRE



No.	Ø of wire	length of wire	
42207	0,8 mm	50 m	40
42208	0,8 mm	100 m	20
42209	0,9 mm	100 m	20
42240	1,0 mm	50 m	40
42210	1,0 mm	100 m	20
42211	1,2 mm	50 m	40
42212	1,2 mm	100 m	20
42213	1,4 mm	30 m	40
42214	1,4 mm	50 m	20
42217	1,8 mm	30 m	40
42218	1,8 mm	50 m	20

WIRE



No.	Ø of wire	length of wire	
42219	2,0 mm	26 m	20
42220	2,0 mm	52 m	20
42221	2,0 mm	78 m	20
42228	3,15 mm	26 m	10
42229	3,15 mm	52 m	10
42230	3,15 mm	78 m	10



WIRE

No.	Ø of wire	length of wire	coating	
42201	0,6 mm	30 m	PVC	50
42202	0,9 mm	30 m	PVC	50

WIRE, GREEN PVC COATED

No.	Ø of wire	length of wire	
42244	1,4 mm	50 m	20
42248	1,8 mm	50 m	20
42249	2,0 mm	50 m	20

WIRE, GREEN PVC COATED

No.	Ø of wire	length of wire	
42251	2,6 mm	26 m	20
42252	2,6 mm	52 m	20
42253	2,6 mm	78 m	20
42255	3,4 mm	26 m	10
42256	3,4 mm	52 m	10
42257	3,4 mm	78 m	10



BARBED WIRE

Zn			
No.	Ø of wire	length of wire	
42260	1,7 mm	50 m	1
42261	1,7 mm	100 m	1

CLAMP OF THE BINDING WIRE

INOX			
No.	dimensions	MOQ	
50040	stainless edge, green	50	
50041	stainless edge, black	50	

CLAMP OF THE BINDING WIRE

10x			
No.	dimensions		
50042		10	



WIRE STRAINER SMALL

Zn			
No.	dimensions		
50030	small, ZN coated	50	
50032	small PVC coated	50	

WIRE STRAINER BIG

Zn			
No.	dimensions		
50031	ZN coated	50	
50033	PVC coated	50	



WIRE STRAINER SMALL LT

Zn			
No.	dimensions		
50037	Zn coated	50	
50038	PVC coated	50	

TIGHTENING EQUIPMENT

No.	dimensions		
50035	2 t	6	
50036	4 t	4	

NEW

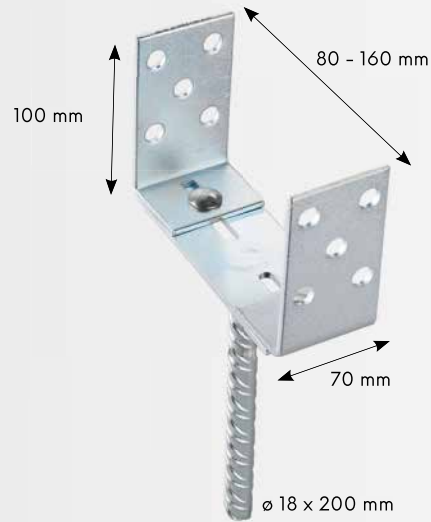

ADJUSTABLE POLE ANCHOR

Zn

No.	specification	thickness	
55465	80 - 160 x 70 mm 100 mm	4 mm	1



Ø 18 x 200mm

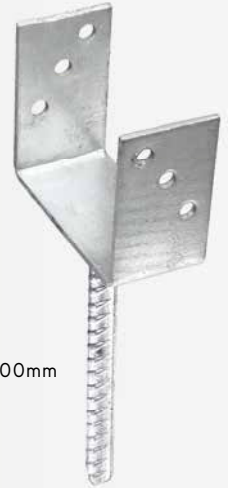

Ø 18 x 200mm

POLE ANCHORE

Zn

No.	dimensions	thickness	
55436	70 x 75 mm 110 mm	4 mm	10
55437	80 x 90 mm 130 mm	4 mm	10

POLE ANCHORE

Zn

No.	dimensions	thickness	
55429	70 x 60 mm 100 mm	4 mm	10
55433	81 x 60 mm 100 mm	4 mm	10
55430	91 x 60 mm 100 mm	4 mm	10
55431	101 x 60 mm 100 mm	4 mm	10
55432	121 x 60 mm 100 mm	4 mm	10



POLE ANCHORE

Zn

No.	Ø of anchor	length of anchor	material thickness	
55400	71 x 71 mm	750 mm	2 mm	1
55401	91 x 91 mm	750 mm	2 mm	1
55406	81 x 81 mm	750 mm	2 mm	1
55402	91 x 91 mm	900 mm	2 mm	1
55403	101 x 101 mm	900 mm	2 mm	1
55404	121 x 121 mm	900 mm	2 mm	1
55405	151 x 151 mm	900 mm	2 mm	1



POLE ANCHORE

Zn

No.	Ø of anchor	length of anchor	material thickness	
55420	71 x 71 mm	150 mm	2 mm	1
55425	81 x 81 mm	150 mm	2 mm	1
55421	91 x 91 mm	150 mm	2 mm	1
55422	101 x 101 mm	150 mm	2 mm	1
55423	121 x 121 mm	150 mm	2 mm	1
55424	151 x 151 mm	150 mm	2 mm	1



SOIL DRILL

No.	Ø	A	B	
61299	110 mm	270 mm	1200 mm	1
61300	140 mm	270 mm	1200 mm	1
61301	170 mm	270 mm	1200 mm	1
61302	200 mm	270 mm	1200 mm	1



UNIVERSAL ANCHORAGE - SCREW SET

reduction

- Ø 24 mm
- Ø 35 mm
- Ø 40 mm
- Ø 48 mm
- Ø 55 mm

Zn 6x

No.	Ø of anchor	length of anchor	dimensions	
55450	60 mm	550 mm	1 ks + 5x reduction	8

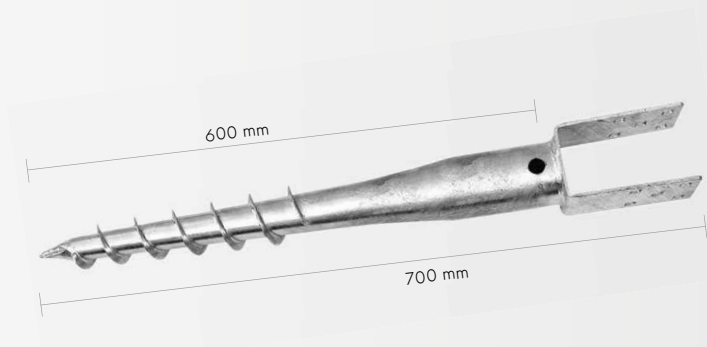

ANCHORAGE SCREW "U,"

Zn

No.	Ø of anchor	length of anchor	material thickness	
55455	71 x 60 mm	100 mm	4 mm	1
55452	81 x 60 mm	100 mm	4 mm	1
55456	90 x 60 mm	100 mm	4 mm	1
55453	101 x 60 mm	100 mm	4 mm	1
55457	110 x 60 mm	100 mm	4 mm	1
55454	121 x 60 mm	100 mm	4 mm	1



POLE ANCHORE WITH ADJUSTABLE SCREW

Zn

No.	Ø of anchor	height of anchor	screw	
55460	80 x 80 mm	150 mm	M16	10
55461	100 x 100 mm	150 mm	M16	10
55462	150 x 150 mm	150 mm	M24	10

BAMBOO FENCING AND SHADING NETS

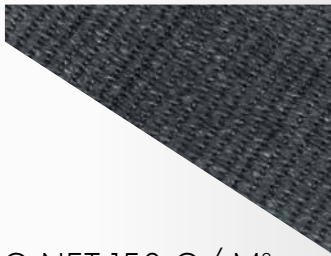
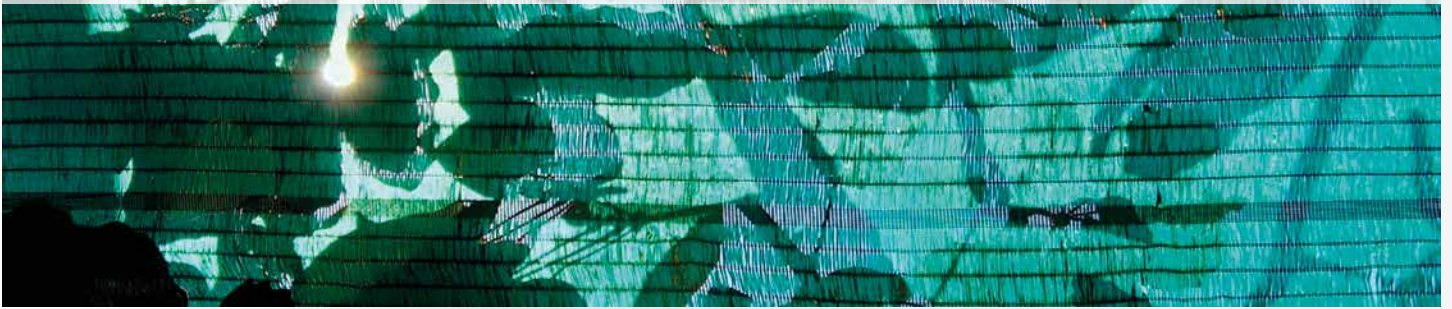

SHADING NET 150 G/ M² ANTHRACITE

· shade 85%



No.	dimensions	
45496	1 x 10 m	1
45497	1,5 x 10 m	1
45498	1,8 x 10 m	1
45499	2 x 10 m	1

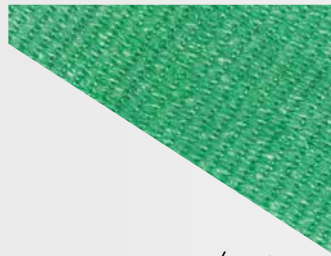

SHADING NET 150 G/ M²

· shade 85%



No.	dimensions	
45460	1 x 10 m	1
45461	1,5 x 10 m	1
45463	1,8 x 10 m	1
45462	2 x 10 m	1

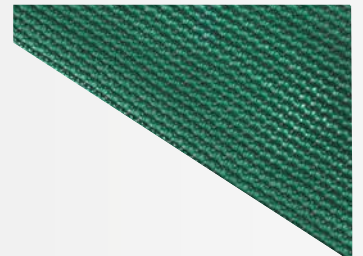

SHADING NET 220 G/ M²

· shade 95%



No.	dimensions	
45465	1 x 10 m	1
45466	1,5 x 10 m	1
45467	2 x 10 m	1

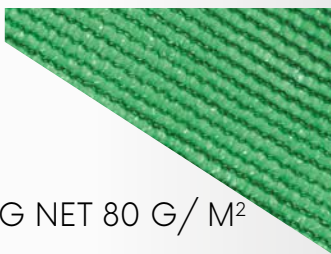

SHADING NET 80 G/ M²



No.	dimensions	
45450	1 x 10 m	1
45451	1,5 x 10 m	1
45453	1,8 x 10 m	1
45452	2 x 10 m	1

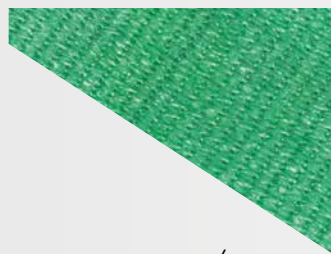

SHADING NET 150 G/ M²

· shade 85%



No.	dimensions	
45480	1,5 x 50 m	1

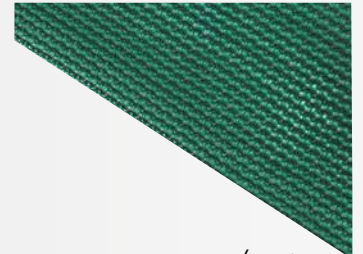

SHADING NET 220 G/ M²

· shade 95%

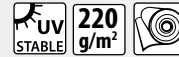

No.	dimensions	
45485	1,5 x 50 m	1

NEW



BINDING TAPES

· EN 50146
· nylon



No.	specification	
23875	120 mm 4,8 mm	1



HOLDS FOR SHADE CLOTH



No.	dimensions	
45470		1



GRILL



TOOL GRILL SET

INOX 18x

No. dimensions
43077



6



TOOL GRILL SET

INOX 3x

No. dimensions
43071 380 mm



16



GRILL PLIERS

INOX

No. dimensions
43072 360 mm



25



GRILL PLATE

4x

No. dimensions
43050 300 x 200 mm

50

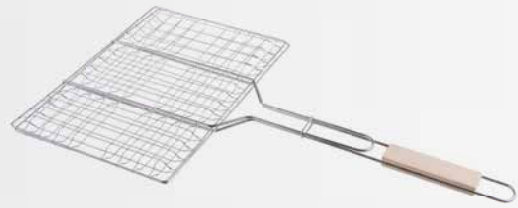
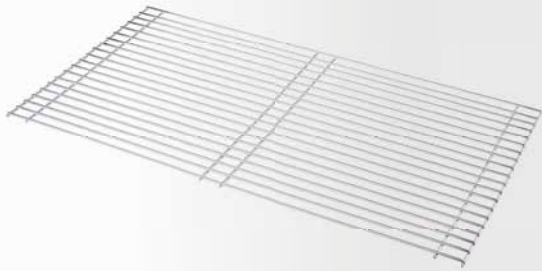

GRILL

No.	dimensions	
43058	58 x 30 mm	20
43060	60 x 40 mm	20
43068	68 x 40 mm	16

GRILL GRID

No.	dimensions	
43084	330 x 290 mm	50

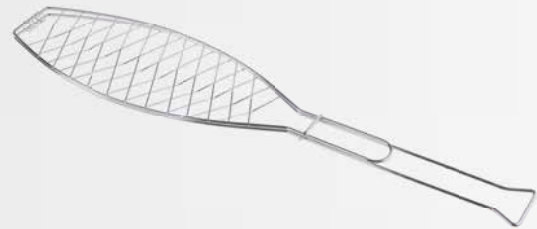
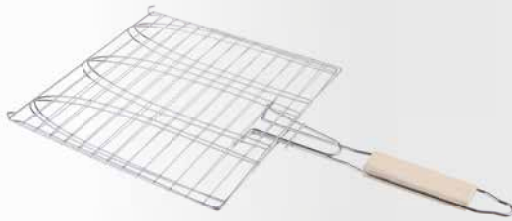

FISH FIREGRATE

No.	dimensions	
43082	280 x 276 mm	50

FISH FIREGRATE

No.	dimensions	
43083	360 x 130 mm	12

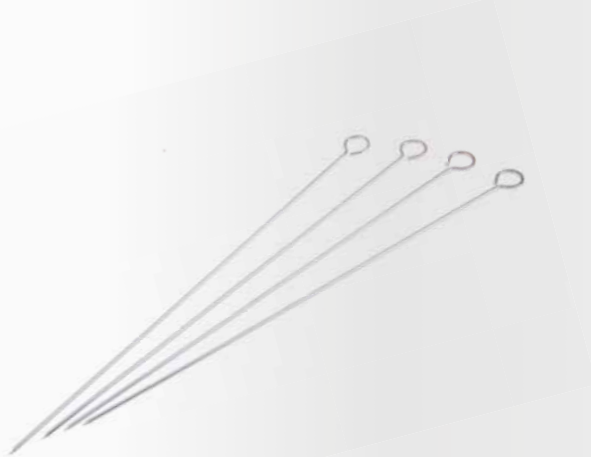

SKEWERS

No.	dimensions	
43086	∅ 3 x 380 mm	80

GRILL FORK

No.	dimensions	
43097	100 cm	100

· grill fork with hygienic atest



GRILL MOTOR 230V



No. dimensions
43090



24



GRILL MOTOR, BATTERY



No. dimensions
43089

48



BARBEQUE BRUSH 2 IN 1

No. dimensions
43098 30 cm

10



BRUSH 3 IN 1

No. dimensions
43099

40



AIR COMPRESSOR

No. dimensions
43087



1



400

LOCK, PADLOCK,
BICYCLE LOCK

404

MONEY BOX AND MAILBOX



406

TIE-DOWN STRAP



409

ROPE, TWINE AND
BINDING TAPES

411

HOT MELT GLUE GUN



413

HOLDER FOR GLASS PLATE



415

DRAIN CLEANER



417

OTHER GOODS



418

LIGHTS



421

PAPER STAND



422

RACKING SYSTEM SU-5



426

KUBALA TOOLS

HARDWARE TOOLS

398 - 431



LOCKS



FESTA

SECURITY ELECTRONIC LOCK BOX

4x AA

- Lock type: electronic, mechanical
- Security key
- Dimensions 350x250x250mm
- Weight 10kg

No.	specification
23270	



FESTA

BRASS CYLINDER LOCK

3x

No.	specification
23001	65 mm · 175 g

10

3x

No.	specification
23000	65 mm · 75 g

15



FESTA

PADLOCK POWER



No.	specification	
23261	25 mm	6
23262	32 mm	12
23263	38 mm	6

No.	specification	
23264	45 mm	6
23265	52 mm	12
23266	63 mm	6

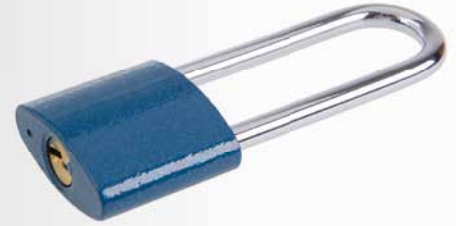

FESTA

PADLOCK POWER EXTENDED



No.	specification	
23211	25 mm	12
23212	32 mm	12
23213	38 mm	6

No.	specification	
23214	45 mm	6
23215	52 mm	6



FESTA

**PADLOCK BRASS,
PVC COATED**



No.	specification	
23310	30 mm	10
23311	40 mm	10
23312	50 mm	6



FESTA

PADLOCK POWER



No.	specification	
23125	25 mm	12
23130	30 mm	12
23135	35 mm	12

No.	specification	
23140	40 mm	12
23150	50 mm	12
23160	60 mm	12



FESTA

PADLOCK POWER



No.	specification	
23274	60 mm	6
23275	70 mm	12



PADLOCK POWER



No.	specification	
23220	25 mm	6
23225	30 mm	6
23232	32 mm	6

No.	specification	
23240	40 mm	6
23250	50 mm	6
23260	60 mm	6



PADLOCK BRASS COATED



No.	specification		No.	specification	
23020	20 mm	12	23040	40 mm	12
23025	25 mm	12	23050	50 mm	12
23030	30 mm	12	23060	60 mm	12
23035	35 mm	12			

PADLOCK BRASS COATED EXTENDED



No.	specification	
23070	40 mm	12



PADLOCK POWER



No.	specification	
23010	50 mm	6

PADLOCK POWER



No.	specification	
23005	40 mm	6
23006	50 mm	6



BICYCLE LOCK WITH NUMBER CODE



No.	specification	
23288	120 cm x Ø 10 mm	1



BICYCLE LOCK WITH NUMBER CODE



No.	specification	
23287	65 cm x Ø 10 mm	1



FESTA

BICYCLE LOCK



No.	specification	
23290	120 cm x Ø 8 mm	1
23291	150 cm x Ø 8 mm	20
23292	180 cm x Ø 8 mm	1



BICYCLE LOCK



No.	specification	
23297	180 cm x Ø 8 mm	25



BICYCLE LOCK



No.	specification	
23282	55 cm x Ø 8 mm	50
23284	65 cm x Ø 8 mm	50



LOCK WITH NUMBER CODE

No.	
23281	20



FESTA

TAGS FOR KEY

100x

· strong circle

No.	
23391	50



TAGS FOR KEY

100x

No.	
23390	1



LATCH

No.	specification	
51514	100 mm	25
51515	120 mm	25
51516	140 mm	25
51517	160 mm	25



PLUG

No.	specification	
51510	100 mm	12
51511	120 mm	12
51512	140 mm	12
51513	160 mm	12



CASH BOXES AND MAILBOXES



BOX FOR KEYS



No.	specification	
70140	250 x 180 x 80 mm - for 48 keys	12
70141	300 x 230 x 90 mm - for 90 keys	8



CASH BOX



No.	width	deep	height	
70120	125 mm	95 mm	60 mm	1



CASH BOX



No.	width	deep	height	
70121	152 mm	118 mm	80 mm	36



CASH BOX



No.	width	deep	height	
70122	200 mm	160 mm	90 mm	20



CASH BOX



No.	width	deep	height	
70123	250 mm	180 mm	90 mm	16



CASH BOX



No.	width	deep	height	
70124	300 mm	240 mm	90 mm	10



CASH BOX



No.	width	deep	height	
70125	370 mm	280 mm	90 mm	8



MAILBOX



No.	color	width	deep	height	
70101	white	290 mm	360 mm	105 mm	5
70100	brown	290 mm	360 mm	105 mm	5

MAILBOX



No.	color	width	deep	height	
70102	white	310 mm	260 mm	90 mm	10
70103	brown	310 mm	260 mm	90 mm	10



MAILBOX



No.	color	width	height	deep	
70104	white	310 mm	360 mm	90 mm	6
70105	brown	310 mm	360 mm	90 mm	5

MAILBOX



No.	color	width	deep	height	
70108	white	370 mm	134 mm	364 mm	5



MAILBOX



INOX

No.	material	width	deep	height	
70107	stainless	360 mm	100 mm	520 mm	6

MAILBOX



INOX

No.	material	width	deep	height	
70106	stainless	360 mm	100 mm	360 mm	5



MAILBOX



INOX

No.	material	width	deep	height	
70109	stainless	310 mm	90 mm	260 mm	6

MAILBOX



INOX

No.	material	width	deep	height	
70110	stainless	310 mm	90 mm	360 mm	6



TIE - DOWN STRAP



FESTA

TIE - DOWN STRAP, SELF-WINDING



2x



No.	width	length	load	pcs	
51070	18 mm	2 m	100 kg	2	12



FESTA

TIE - DOWN STRAP, SELF-WINDING



No.	width	length	load	pcs	
51071	25 mm	3,5 m	300 kg	1	8



FESTA

TIE - DOWN STRAP, SELF-WINDING



No.	width	length	load	pcs	
51072	35 mm	4 m	500 kg	1	6



FESTA

TIE - DOWN STRAP



No.	width	length	load	pcs	
51040	25 mm	6 m	1000 kg	1	1
51041	35 mm	8 m	2000 kg	1	1
51042	35 mm	8 m	3000 kg	1	1
51043	50 mm	10 m	5000 kg	1	1



FESTA

TIE - DOWN STRAP



2x



No.	width	length	load	pcs	
51060	25 mm	5 m	750 kg	2	5



FESTA

TIE - DOWN STRAP



No.	width	length	load	pcs	
51065	50 mm	10 m	960 kg	1	6



FESTA

TIE - DOWN STRAP



No.	width	length	load	pcs	
51026	75 mm	5 m	3000 kg	1	4

NEW

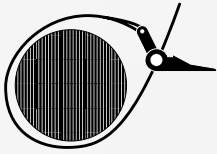

FESTA

TIE - DOWN STRAP



No.	width	length	load	pcs	
51032	25 mm	5 m	500 kg	1	1

FESTA

TIE - DOWN STRAP



No.	width	length	load	pcs	
51017	50 mm	6 m	480 kg	2	5
51018	50 mm	6 m	480 kg	1	10



TIE - DOWN STRAP



No.	width	length	specification	
51022	25 mm	5 m	with hooks	40
51023	50 mm	5 m	with hooks	12

FESTA

TIE - DOWN STRAP

PE

• softened EVA pad



No.	width	length	pcs	
51046	38 mm	4 m	1	20



TIE - DOWN STRAP



No.	width	length	specification	
51030	50 mm	6 m	with hooks	20
51034	50 mm	8 m	with hooks	10

TIE - DOWN STRAP

2x



No.	width	length	pcs	
51020	25 mm	2,5 m	2	100



TIE - DOWN STRAP

PE



No.	width	length	pcs	
51045	25 mm	4 m	1	50

RUBBER STRAP WITH HOOPCS

2x



No.	length	Ø	pcs	
51013	1,2 m	8 mm	2	1





RUBBER STRAP WITH HOOPCS

2x

No.	length	pcs	
51008	1 m	2	25



RUBBER STRAP WITH HOOPCS

No.	length	∅	pcs	
51009	1 m	10 mm	1	25



SET OF RUBBER STRAP WITH HOOPCS

8x

- 2 x 0,4 m
- 2 x 0,6 m
- 1 x 0,8 m
- 1 x 1,0 m

No.	length	∅	pcs	
51011	1 m	8 mm	8	10



RUBBER STRAP WITH HOOPCS

2x

No.	length	∅	pcs	
51001	80 cm	10 mm	2	50
51002	100 cm	10 mm	2	50
51003	150 cm	10 mm	2	50
51004	200 cm	10 mm	2	50



RUBBER STRAP WITH HOOPCS

2x

No.	length	∅	pcs	
51007	1 m	8 mm	2	25



RUBBER ROPE - SPIDER

No.	length	∅	specification	
51010	80 cm	8 mm	8 ramen	50



RUBBER NET WITH HOOPCS

No.	length	width	
51015	80 cm	120 cm	20



RUBBER STRAP



No.	length	∅	
51036	20 m	8 mm	10
51037	20 m	10 mm	6





HOOPCS FOR RUBBER STRAPS

20x

No.	length	
51038	8 mm	30



ROPE



No.	length	Ø	
50915	5 m	8 mm	1
50916	25 m	8 mm	1
50917	25 m	10 mm	1
50918	25 m	12 mm	1
50919	25 m	14 mm	1



ALUMINIUM HOOK

ALU

MOQ
2

No.	Ø	length	
51187	5 mm	50 mm	2
51200	6 mm	60 mm	2
51202	7 mm	70 mm	2



NYLON ROPE

No.	length	Ø	
51050	50 m	8 mm	10
51051	50 m	10 mm	4



NYLON ROPE

No.	length	Ø	
51055	80 m	1,5 mm	50
51056	50 m	2 mm	50
51057	20 m	4 mm	50



PP TWINE

No.	weight	
50909	500 g (250 m)	1
50910	1000 g (500 m)	1
50911	5000 g (2500 m)	1

PP TWINE

No.	weight	
50905	80 g	80
50906	100 g	100
50907	200 g	50



JUTE TWINE

No.	weight	
50900	80 g (61 m)	1
50901	100 g (76 m)	1
50902	200 g (153 m)	1

WAXED TWINE



No.	length	Ø	
50920	50 m	1 mm	80

NEW



BINDING TAPES

· EN 50146
· nylon

50x

No.	specification	
23875	120 mm 4,8 mm	1



BINDING TAPES

100x

· EN 50146
· nylon

No.	length	width	
23880	100 mm	2,5 mm	1
23882	150 mm	2,5 mm	1
23884	200 mm	3,6 mm	1



BINDING TAPES

10x

UV STABLE

No.	length	width	
23865	160 mm	7,5 mm	1



BINDING TAPES WHITE

50x

· EN 50146
· nylon

No.	length	width	
23850	120 mm	2,5 mm	1
23854	200 mm	3,6 mm	1
23856	250 mm	3,6 mm	1
23858	250 mm	4,8 mm	1
23860	300 mm	4,8 mm	1
23864	400 mm	4,8 mm	1
23866	500 mm	4,8 mm	1
23868	400 mm	7,6 mm	1
23870	500 mm	7,6 mm	1



FESTA

VELCRO TAPE 3 PCS

3x

No.	width	length	
37295	20 mm	150 mm	1
37296	20 mm	200 mm	1
37297	20 mm	250 mm	1



BINDING TAPES BLACK

50x

· EN 50146
· nylon

No.	length	width	
23810	120 mm	2,5 mm	1
23814	200 mm	3,6 mm	1
23816	250 mm	3,6 mm	1
23818	250 mm	4,8 mm	1
23820	300 mm	4,8 mm	1
23824	400 mm	4,8 mm	1
23826	500 mm	4,8 mm	1
23828	400 mm	7,6 mm	1
23830	500 mm	7,6 mm	1



BINDING TAPE, VELCRO

No.	specification	
45471	12 mm x 5 m	1





FESTA

HOT MELT GLUE GUN - WIRELESS



No.	specification		
89975	80 W 230 V	Ø glue stick 11,2 mm	20



HOT MELT GLUE GUN



No.	specification		
89973	60 W 230 V	Ø glue stick 11,2 mm	20



HOT MELT GLUE GUN



No.	specification		
89970	15 W 230 V	Ø glue stick 7,2 mm	25



HOT MELT GLUE STICK - TRANSPARENT

No.	Ø	length	pcs	
89985	11,2 mm	200 mm	10	50
89987	11,2 mm	200 mm	1 kg	25



HOT MELT GLUE STICK - TRANSPARENT

No.	Ø	length	pcs	
89980	7,2 mm	100 mm	12	100
89988	7,2 mm	100 mm	1 kg	25



HOT MELT GLUE STICK - MULTICOLOUR

No.	Ø	length	pcs	
89990	11,2 mm	200 mm	10	50



HOT MELT GLUE STICK - MULTICOLOUR

No.	Ø	length	pcs	
89989	7,2 mm	100 mm	12	100



FESTA

HEATING GUN

voltage	230V / 50Hz
power consumption	2000W
position of switch	0 - I (350°C) - II (600°C)
accessories	stainless extensions - 4 pcs



No.	specification
35320	2000 W

5

FESTA

HEATING GUN WITH REGULATION OF TEMPERATURE AND AIR FLOW

voltage	230V / 50Hz
power consumption	2000W
position of switch	0 - I (50°C) - II (50 - 600°C)
air flow	250 - 500 l/min.
accessories	stainless extensions - 4 pcs
· digital display	



No.	specification
35322	2000 W

5

NEW



FESTA

SUCTION TILE HOLDER WITH PRESSURE INDICATOR

rough and structured surfaces

No.	Specification
36325	max. 220 kg



1

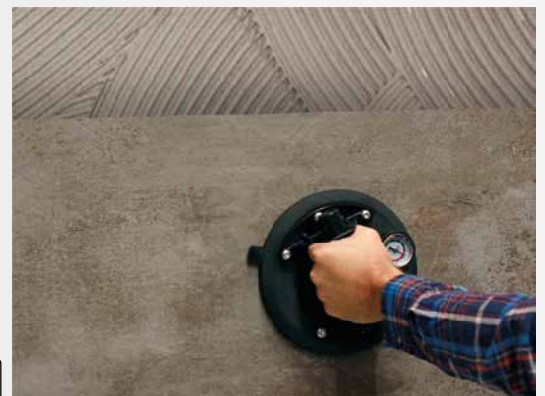



FESTA

HOLDER FOR GLASS PLATE

position	max. load
horizontal position	50 kg
vertical position	50 kg

ALU



No.	specification
36314	single

20

HOLDER FOR GLASS PLATE



No.	specification
36305	single

60



FESTA

HOLDER FOR GLASS PLATE

position	max. load
horizontal position	80 kg
vertical position	100 kg

ALU



No.	specification
36313	double

20

HOLDER FOR GLASS PLATE



No.	specification
36306	double

20



FESTA

HOLDER FOR GLASS PLATE

position	max. load
horizontal position	120 kg
vertical position	150 kg

ALU



No.	specification
36318	triple

10

HOLDER FOR GLASS PLATE



position	max. load
horizontal position	80 kg
vertical position	100 kg

No.	specification
36319	triple

10



STEELYARD ANALOG

No.	max.	
24260	50 kg	10



STEELYARD

No.	max.	
24212	12,5 kg	48
24225	25 kg	6
24250	50 kg	6
24255	100 kg	6
24258	150 kg	6



TWEEZERS WITH LED LIGHT

No.	specification	
50005	95 mm	8



TWEEZER SET STAINLESS

No.	specification	
50004		1

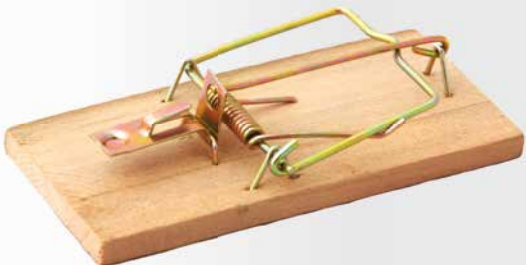
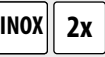

MOUSETRAP

No.	specification	
70221	90 x 45 mm wooden	1



MOUSETRAP

No.	specification	
70220	97 x 47 mm plastic	48



NEW



RADIATOR BLEED KEY WITH WATER TANK

No.	Specification	
17459	50 ml	1





DRAIN CLEANER

· can be used with drilling-machine



No.	length	Ø
50014	6 m	6 mm



6



DRAIN CLEANER

No.	length	Ø
50009	3 m	5 mm



40

DRAIN CLEANER

No.	length	Ø
50010	3 m	10
50011	5 m	5
50012	10 m	3
50013	15 m	4



SUCTION PUMP

No.	length	Ø
50015	385 mm	65 mm



30



DRAW TAPE

No.	length	Ø
51181	8 m	5 mm
51182	10 m	5 mm



25
25

NEW

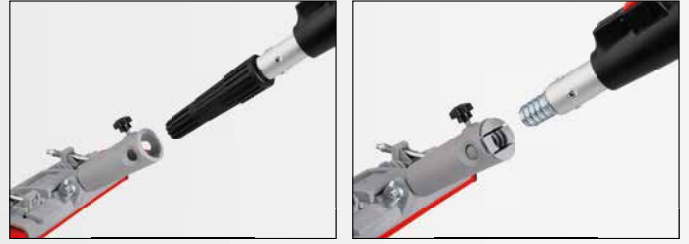

FESTA
TELESCOPIC POLE
- thread for 31610, 34203

No.	Specification	
52011	88 - 140 cm	1



TELESCOPIC POLE

ALU

No.	length		
52010	120 cm	ALU	50
52012	240 cm	ALU	25



TELESCOPIC POLE

No.	length		
52020	300 cm	steel	10



TELESCOPIC POLE

No.	length		
52030	240 cm	fiberglass	6



PICK UP TOOL FOR GARBAGE
· rotary 90°

No.	length	
61235	81 cm	12

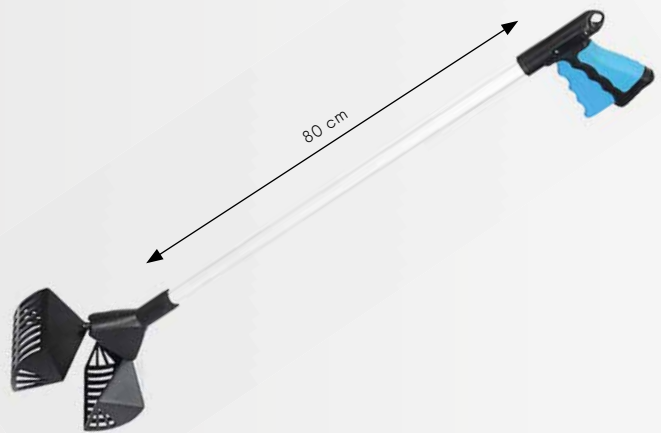

GARBAGE PLIERS
· max. 4 kg

No.	
61236	12



OILING CAN

No.	specification	
50020	300 ml	10

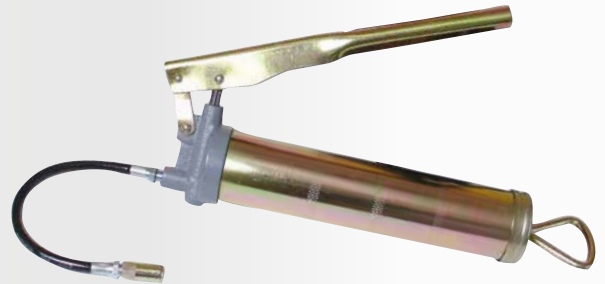

GREASE GUN

- bulk loading
- cartridge loading
- loading with dispenser



No.	specification	
50022	400 ml	20



CANISTER PUMP

No.	specification	
50017		10



OILING CAN

No.	specification	
50019	90 ml	1



BELT WRENCH

No.	specification	
50021	60 x 140 mm	6



FLEXIBLE FUNNEL

No.	specification	
50025	60 x 140 mm	50



HOSE WITH SELF-PRIMING VALVE

No.	length	∅	
50026	180 cm	15 mm	24



24

LAMPS AND LIGHTS



FESTA

LED LIGHT



No.	specification
37645	200 mm 3 x AAA

MOQ
12

12

FESTA

LED HEAD LAMP

Weight	42 g
Light source	1 x 1 W white LED + 2x red LED
Battery:	3 x AAA
Dimensions	40 x 59 x 32 mm
Time of lighting	45 h
Aperture	120 lumen
Light distance	60 m (100% battery)
Type of lighting	4

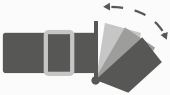

· 5 positions



No.	specification
37641	120 lumen + red light



1

FESTA

LED HEADLAMP



No.	specification
37640	120 lumen + red light



6



FESTA
LED LAMP

LED light 3x AA

No. 37650

12



FESTA
LED LIGHT

ALU LED light 2xAA 80 lumen

No.	specification
37630	185 mm 2 x AA

20

LED LIGHT

output:	0,6 W
color temperature:	700k
battery:	2xD
weight:	138g
length of light:	30 m
aperture:	50 lm



ALU LED light 2xAA 80 lumen

No.	specification
37621	185 mm

6



BRACKET WHITE

MOQ
2

No.	specification	
81100	100 x 75 mm	24
81101	125 x 100 mm	24
81102	150 x 125 mm	24
81103	200 x 150 mm	24
81104	250 x 200 mm	24
81105	300 x 250 mm	24
81106	350 x 300 mm	24



HOOK BRACKET SINGLE

No.	specification	
81053	50 cm	10
81054	80 cm	10
81056	150 cm	10
81057	200 cm	10



HOOK BRACKET SINGLE

No.	specification	
81070	10 cm	10
81071	15 cm	10
81072	20 cm	10
81074	30 cm	10
81075	35 cm	10
81077	50 cm	10



PAPER STAND FESTA

No.	specification
81602	60 x 40 x 175 cm - ENG



PAPER STAND FESTA POWER TOOLS

No.	specification
81603	60 x 40 x 175 cm



PAPER STAND FOR LEVELING SYSTEMS

No.	specification
37179	60 x 40 x 175 cm - ENG



RACKING SYSTEM SU - 5



WE CAN ALSO ARRANGE YOU REQUIRED SHELF ASSEMBLY



FESTA STAND + ACCESORIES

No.	specification		
81011	stand FESTA	220 x 100 cm	1
81011A	stand 81011 + sticker AQUATIC		1
81011F	stand 81011 + sticker FESTA CZ		1
81011G	stand 81011 + sticker FESTA GB		1
81011H	stand 81011 + sticker FESTA SK		1
81011R	stand 81011 + sticker ROSA		1
81012	shelf for the stand FESTA	100 x 40 cm	8
81013	hook 10 cm		10
81014	hook 16 cm		10
81015	hook 20 cm		10
81035	hook with plastic price tag 20 cm		10
81016	hook 30 cm		10
81036	hook with plastic price tag 30 cm		10
81022	wire basket - big, 50 cm		1
81023	wire basket - small, 40 cm		1
81024	partition - big, 50 cm		1
81025	partition - small, 40 cm		1





RACKING SYSTEM SU - 5



WE CAN ALSO ARRANGE YOU REQUIRED SHELF ASSEMBLY

No.	specification	
81200	Handstand 40/2400 mm anchored	1
81201	Handstand 80/1108 mm	1
81202	Handstand 80/1208 mm	1
81203	Handstand 80/1408 mm	1
81204	Handstand 80/1608 mm	1
81205	Handstand 80/1808 mm	1
81206	Handstand 80/2000 mm	1
81207	Handstand 80/2108 mm	1
81208	Handstand 80/2208 mm	1
81209	Handstand 80/2308 mm	1
81210	Handstand 80/2408 mm	1
81211	Handstand 80/2600 mm	1
81212	Handstand 60/1000 mm	1
81213	Handstand 60/1208 mm	1
81214	Handstand 60/1408 mm	1
81215	Handstand 60/1608 mm	1
81216	Handstand 60/1808 mm	1
81217	Handstand 60/2108 mm	1
81218	Handstand 60/2208 mm	1
81225	Handstand 30/2108 mm front	1
81486	Handstand 60/2000 mm	1
81219	Adapter of handstand 80x30/100mm	1
81220	Adapter of handstand 80x30/400 mm	1
81221	Adapter of handstand 80x30/600 mm	1
81222	Adapter of handstand 60x30/400 mm	1
81223	Corner handstand 90° 2100mm	1
81224	Corner handstand 90° 2200mm	1
81226	Support 80	1
81227	Support 60	1
81228	Clutch gondolas with a shelf 80	1
81229	Anchor bar	1
81230	Anchor hook	1
81231	Anchoring light	1
81232	Anchoring top	1
81233	Filling 400	1
81234	Filling 500	1
81235	Filling 600	1
81236	Filling 700	1
81237	Filling 800	1
81238	Console low 200	1
81239	Console low 300	1
81240	Console low 400	1
81241	Console low 500	1
81242	Console high 400	1
81243	Console high 500	1
81244	Console high 600	1
81245	Console high 700	1
81246	Console low 300 double	1
81247	Console low 400 double	1
81248	Console low 300 double	1
81251	Console RR 80	1
81249	Console high double 500	1
81250	Beam showcase 400/2000	1
81252	Hyphen trough shelves	1
81253	Hyphen low 300	1
81254	Hyphen low 400	1
81255	Hyphen low 500	1
81256	Hyphen low 300 glass	1
81257	Hyphen low 400 glass	1
81258	Hyphen low 500 glass	1
81259	Hyphen high 300 glass	1
81262	Hyphen high 300 plexi	1
81263	Hyphen high 400 plexi	1
81264	Hyphen high 500 plexi	1
81260	Hyphen high 400 glass	1
81261	Hyphen high 500 glass	1
81265	Side of showcase 400/2000	1
81266	Sidewall roofing RR 80	1
81267	Sidewall tray 500mm	1
81268	Sidewall showcase 500	1
81269	Beam showcase 500	1
81271	Sidewall shelves low 300 plastic	1
81272	Sidewall shelves low 400 plastic	1
81273	Sidewall shelves low 500 plastic	1
81274	Sidewall high glass 300/250	1
81275	Safety fuse	1
81276	Sidewall high glass 500/250	1
81277	Sidewall shelves high 400	1
81278	Sidewall shelves high 500	1
81270	Beam roofing RR 80	1
81279	Beam roofing	1
81280	Sidewall roofing left	1
81281	Sidewall roofing right	1
81282	Suspension arm	1
81284	Double shoulder 400/10	1
81285	Double shoulder 300/8	1
81286	Simple shoulder 350	1
81287	Simple shoulder 500	1
81288	Simple shoulder 250	1
81289	Double hinge 100	1
81290	Double hinge 200	1
81291	Double hinge 300	1
81292	Hinge 130 V	1

No.	specification	
81293	Simple hinge 100	1
81294	Simple hinge 200	1
81295	Simple hinge 300	1
81296	Hook with horizontal bar 200	1
81297	Hook with horizontal bar 300	1
81298	Lock showcase	1
81299	Hyphen wire 360mm high	1
81300	Hyphen wire 460 mm high	1
81301	Hyphen wire 560 mm high	1
81302	Hyphen wire 560 mm nízké	1
81303	Bracket 300 double L	1
81304	Bracket 300 double P	1
81305	Bracket 400 double L	1
81306	Bracket 400 double P	1
81307	Bracket 500 double L	1
81308	Bracket 500 double P	1
81309	Shelf semicircle 300	1
81310	Shelf semicircle 400	1
81311	Shelf semicircle 500	1
81312	Sokl pülkruhu 500	1
81313	Forehead base semicircle 500	1
81314	Bracket 300 price tag semicircle	1
81315	Bracket 400 price tag semicircle	1
81316	Bracket 500 price tag semicircle	1
81317	Shelf semicircle 600	1
81318	Plinth semicircle 600	1
81319	Forehead base semicircle 600	1
81320	Price tag P 7,5x5 cm	1
81321	Price tag P 2,6x3,2 cm	1
81322	Price tag P 5,0x4,0 cm	1
81323	Perforated shelf 500/1000	1
81324	Connector upright 80, Module 1	1
81325	Rear panel 10x100cm	1
81326	Rear panel 20x100cm	1
81327	Rear panel 40x100cm	1
81328	Perforated rear panel 20x100 cm EUR	1
81329	Perforated rear panel 40x100 cm EUR	1
81330	Cover gondolas 8x100cm	1
81331	Cover gondolas 6x100cm	1
81332	Beam hinges 100cm	1
81333	Glass shelf 985/300 vitrine	1
81334	Glass shelf 985/400 vitrine	1
81335	Wooden shelf 47/98,5	1
81336	Wire shelf 1000/500	1
81337	Troughed shelf 1000x500	1
81338	Shelf 200/1000	1
81339	Shelf 300/1000	1
81340	Shelf 400/1000	1
81341	Shelf 500/1000	1
81342	Shelf 400/1000 RAL7015	1
81343	Shelf 500/1000 RAL7015	1
81347	High frame showcases 1000/400	1
81348	Glass frame high showcases 1000/400	1
81349	Female insert shelf	1
81350	Suspended ceiling metal shelves 500/100	1
81352	Front support high glass 1000 mm	1
81353	Front support high plexi	1
81354	Front support low plastic 1000 mm	1
81355	Price bar, 1000mm	1
81356	Comb socket rack	1
81351	Comb for high dividers, 1000	1
81357	Comb, 1000 mm	1
81403	Comb for high dividers, 1250 mm	1
81420	Comb for high dividers, 625 mm	1
81358	Double-groove door showcases	1
81359	Price tag holder, 1000mm	1
81360	Door showcases 1000/2000	1
81361	Forehead roofing, 1000mm	1
81362	Tile roofing, 1000mm	1
81363	Tray door	1
81364	Sliding door showcases	1
81365	Mirror showcases	1
81366	Hinge frame, module 1	1
81367	Curtain rod	1
81370	Trash wire oblique	1
81371	Tour 1000mm full plate	1
81372	Skirting the counter SU 5 1000mm	1
81373	Counter glassed 1000mm	1
81374	Counter with stainless steel plate 1000mm	1
81375	Counter with full plate 600mm	1
81376	Shelf counter 600mm	1
81377	Counter glassed 600mm	1
81378	Shelf counter 1000mm	1
81379	Long shelf counter	1
81380	Segment counter high 90°	1
81381	Double-groove counter 1000mm, couple	1
81382	Sliding doors counter 1000mm, couple	1
81383	Drawer board	1
81384	Wire shelf RDE 1000/360mm	1
81385	Wire shelf RDE 1000/460mm	1
81386	Wire shelf RDE 1000/560mm	1
81387	Price bar RDE 1000 mm	1
81388	Rear panel 100/1250mm full	1

No.	specification	
81389	Rear panel 200/1250mm full	1
81390	Rear panel 400/1250mm full	1
81391	Rear panel 200/1250mm perforated	1
81393	Cover gondolas 80/1250mm	1
81392	Rear panel 400/1250mm perforated	1
81394	Cover gondolas 60/1250mm	1
81395	Beam hinges 1250mm	1
81396	Shelf 200/1250mm	1
81439	Beam hinges 1000 mm	1
81344	Shelf 300/1000 respecificationrced	1
81345	Shelf 400/1000 respecificationrced	1
81346	Shelf 500/1000 respecificationrced	1
81397	Shelf 300/1250mm	1
81400	Shelf 300/1250mm, respecificationrced	1
81401	Shelf 400/1250mm, respecificationrced	1
81402	Shelf 500/1250mm, respecificationrced	1
81398	Shelf 400/1250mm	1
81399	Shelf 500/1250mm	1
81404	Front fulcrum low 1250mm, white plastic	1
81405	Price bar, 1250mm	1
81406	Comb 1250mm	1
81407	Price tag holder, 1250mm	1
81408	Forehead roofing, 1250mm	1
81409	Tile roofing, 600x1250mm	1
81410	Rear panel 100/625 full	1
81411	Rear panel 200/625 full	1
81412	Rear panel 400/625 full	1
81413	Rear panel 400/625 perforated	1
81414	Cover gondolas 80/650	1
81415	Cover gondolas 60/650	1
81416	Beam hinges, module 3	1
81432	Beam hinges, 1330mm	1
81417	Shelf 300/625	1
81418	Shelf 400/625	1
81419	Shelf 500/625	1
81421	Front support low 625, white plastic	1
81422	Price bar 625mm	1
81423	Comb 625mm	1
81424	Price tag holder, 625mm	1
81425	Rear panel 100/1330 full	1
81457	Molded plastic abutment low 200	1
81426	Rear panel 200/1330 full	1
81427	Rear panel 400/1330 full	1
81428	Rear panel 200/1330 perforated S	1
81429	Rear panel 400/1330 perforated S	1
81430	Cover gondolas 80/1330	1
81431	Cover gondolas 60/1330	1
81433	Shelf 300/1330	1
81434	Shelf 400/1330	1
81435	Shelf 500/1330	1
81436	Price bar, 1330 mm	1
81437	Comb 1330 mm	1
81438	Price tag holder 1330 mm	1
81440	Wire shelf - basket	1
81441	Rear panel 100 fillet	1
81442	Rear panel 400 fillet	1
81443	Forehead plinth fillet 500/1000mm	1
81444	Forehead plinth fillet 600 mm	1
81445	Rear panel fillet 400mm perforated	1
81447	Shelf 300 fillet	1
81448	Shelf 400 fillet	1
81449	Shelf 500 fillet	1
81450	Shelf 600 fillet	1
81451	Price tag holder 300 fillet	1
81452	Price tag holder 400 fillet	1
81453	Price tag holder 500 fillet	1
81454	Price bar 300 fillet	1
81455	Price bar 400 fillet	1
81456	Price bar 500 fillet	1
81458	Wire shelf basket U 1000/400	1
81459	Wire shelf basket U 1000/500	1
81460	Corner forehead plinth 90°	1
81461	Rear corner panel 100, stand 60	1
81462	Rear corner panel 200, stand 60	1
81463	Rear corner panel 400, stand 80	1
81466	Rear corner panel 100, stand 80	1
81467	Rear corner panel 400, stand 60	1
81468	Police corner 90° 400mm	1
81469	Police corner 90° 500mm	1
81470	Price tag holder corner 90° 400mm	1
81471	Price tag holder corner 90° 500mm	1
81472	Price bar fillet 90° 400mm	1
81473	Price bar fillet 90° 500mm	1

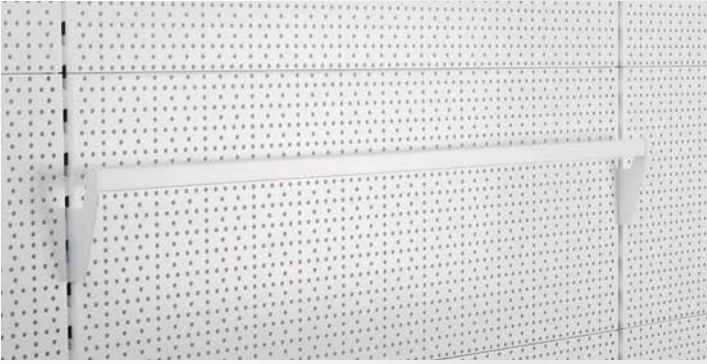

TRADE BRACKET

· compatible with FESTA stand

No.	specification	
81150	1000 × 50 × 135 mm	1

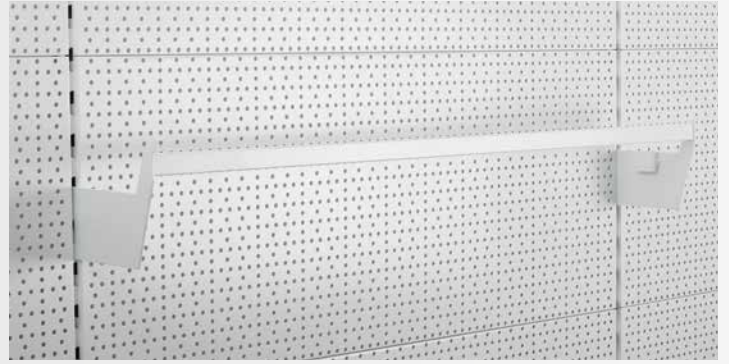

TRADE BRACKET

· compatible with FESTA stand

No.	specification	
81151	1000 × 150 × 135 mm	1

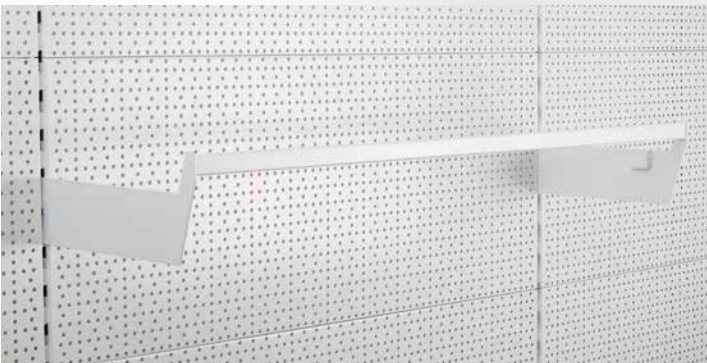

TRADE BRACKET

· compatible with FESTA stand

No.	specification	
81152	1000 × 350 × 135 mm	1

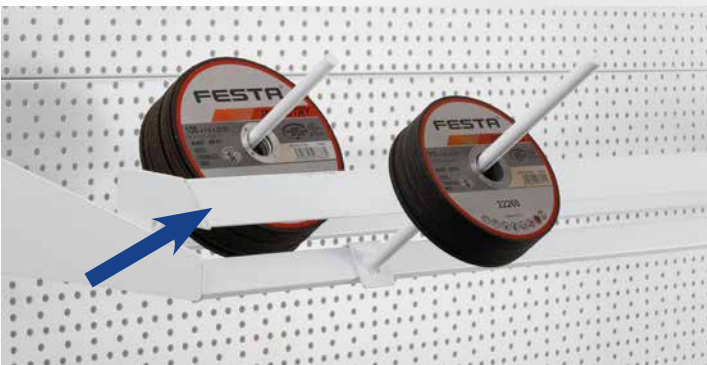
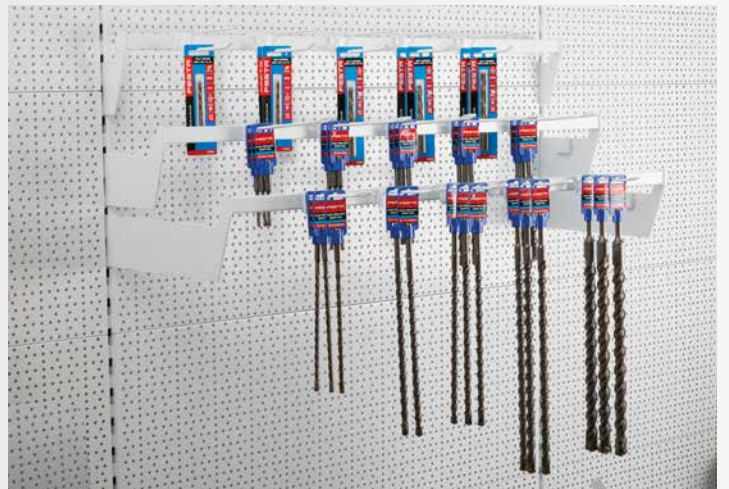

PRICE HOLDER

· compatible with FESTA stand

No.	specification	
81155	1000 × 80 × 100 mm	1

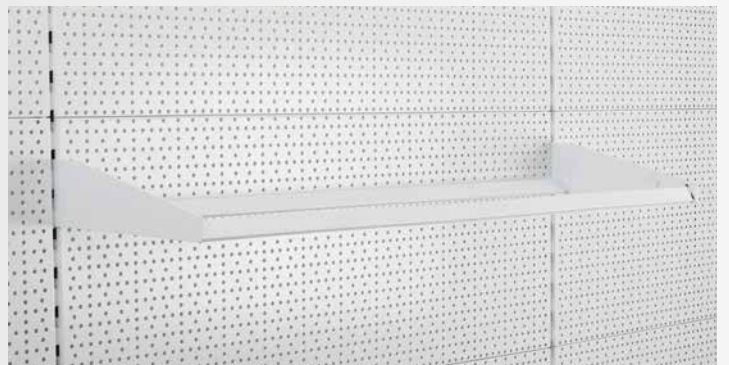

FRAME FOR CUTTING DISCS

· compatible with FESTA stand

No.	specification	
81170	1000 × 450 × 85 mm	1

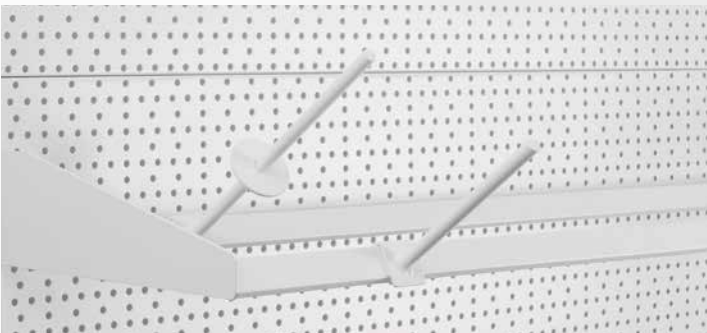

HOOK FOR CUTTING DISCS

· compatible with FESTA stand

No.	specification	
81186	150 mm	1
81185	250 mm	1



HOOK FOR CORDLESS TOOLS

· compatible with FESTA stand

No.	specification	
81189		1

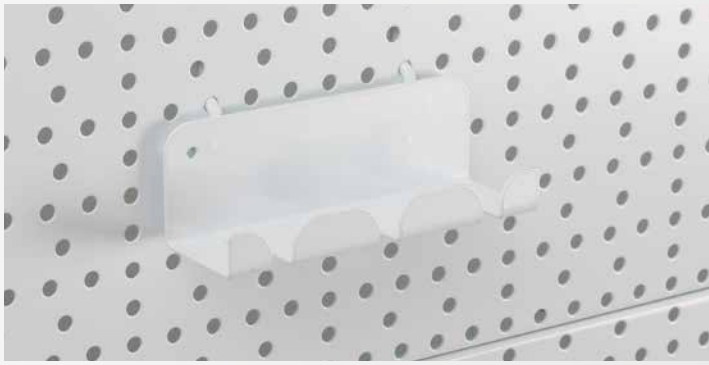

SAWS HOLDER

· compatible with FESTA stand

No.	specification	
81190		1

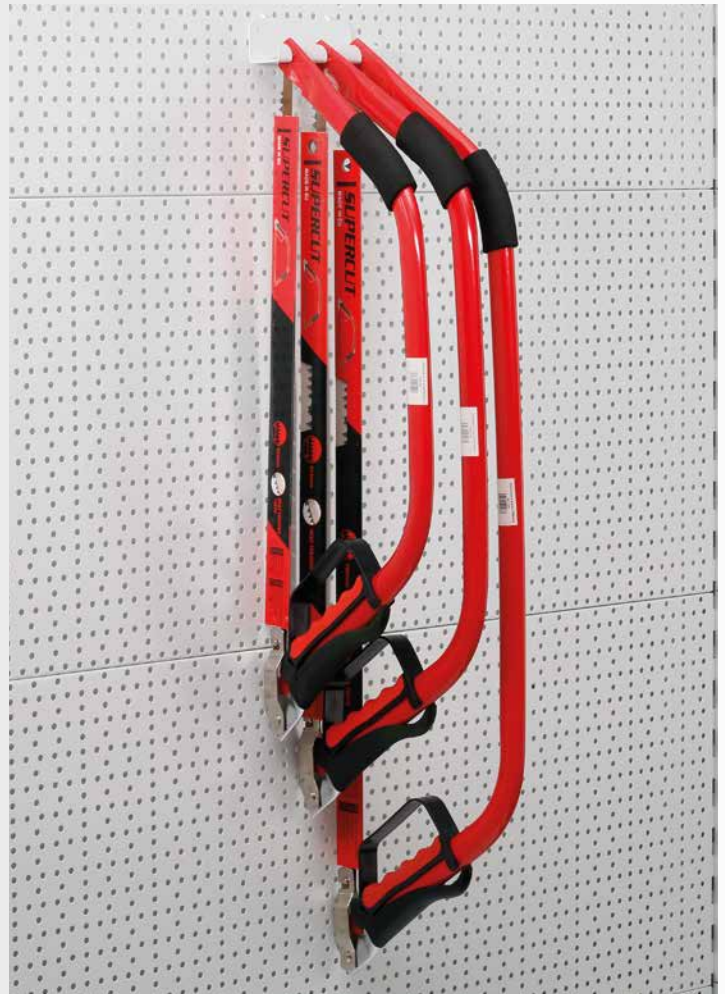

SHELF FOR DISCS

· compatible with FESTA stand

No.	specification	
81191	220 × 220 × 200 mm	1

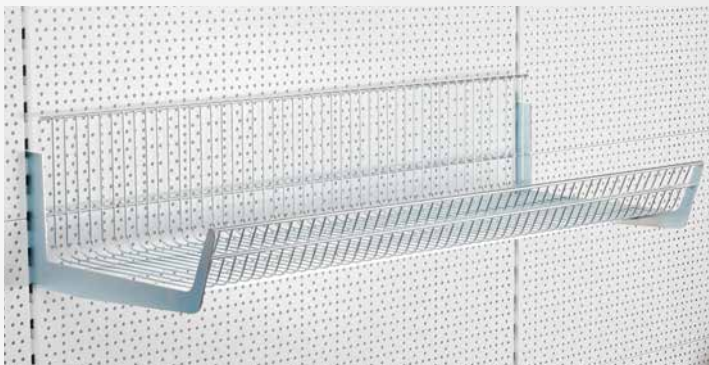

WIRE BASKET

· compatible with FESTA stand

No.	specification	
81160	1000 × 470 × 180 mm	1



DIVIDER

· compatible with FESTA stand

No.	specification	
81165	470 × 180 mm	1

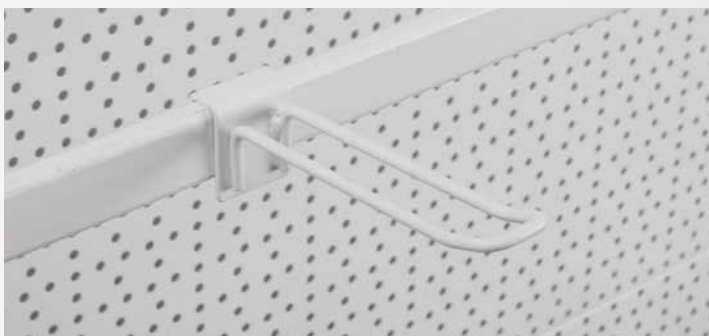

HOOK FOR HORIZONTAL BAR

· compatible with FESTA stand

No.	specification	
81175	120 mm	1
81178	180 mm	1



HOOK FOR HORIZONTAL BAR

· compatible with FESTA stand

No.	specification	
81180	120 mm	1



Kubala
STAINLESS TROWEL

INOX

No.	specification		
33100	130 x 270 mm	straight, 2 round corners	10



Kubala
STAINLESS TROWEL

INOX

No.	specification		
33102	130 x 270 mm	straight, G-1 handle	10



Kubala
STAINLESS TROWEL

INOX

No.	specification		
33105	130 x 350 mm	straight, G-8 handle	6



Kubala
STAINLESS TROWEL

INOX

No.	specification		
33107	110 x 270 mm	corner	10



Kubala
STAINLESS TROWEL

INOX

No.	specification		
33110	130 x 270 mm	straight, G-11 handle	10



Kubala
STAINLESS TROWEL

INOX

No.	specification		
33112	130 x 270 mm	teeth 6 x 6, G-11 handle	10
33113	130 x 270 mm	teeth 8 x 8, G-11 handle	10
33114	130 x 270 mm	teeth 10 x 10, G-11 handle	10



Kubala
STAINLESS TROWEL

INOX

No.	specification		
33120	130 x 480 mm	straight, G-12 handle	10



Kubala
STAINLESS TROWEL

INOX

No.	specification		
33123	130 x 480 mm	teeth 8 x 8, G-12 handle	10
33124	130 x 480 mm	teeth 10 x 10, G-12 handle	10



Kubala
STAINLESS TROWEL

INOX

No.	specification	
33127	130 x 480 mm 2 round corners	10



Kubala
STAINLESS TROWEL

INOX

No.	specification	
33131	80 x 200 mm G-1 handle	10
33132	75 x 95 x 240 mm trapezoidal G-1 handle	10



Kubala
STAINLESS TROWEL

INOX

No.	specification	
33135	130 x 270 mm oblique tooth 8 mm, G-1 handle	10



Kubala
STAINLESS TROWEL

INOX

No.	specification	
33137	130 x 270 mm teeth half round, G-1 handle	10



Kubala
TROWEL

INOX

No.	specification	
33140	50 mm	20
33141	60 mm	20
33142	80 mm	20
33143	100 mm	20



Kubala
PLASTIC TROWEL ABS

INOX

No.	specification	
33150	130 x 240 mm	12

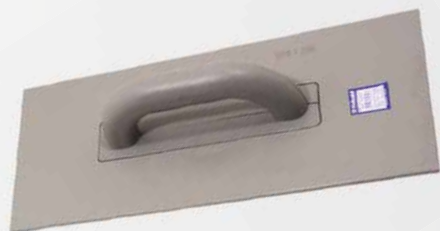

Kubala
PLASTIC TROWEL

INOX

No.	specification	
33151	180 x 400 mm	1
33152	130 x 600 mm	1



Kubala
PLASTIC TROWEL

INOX

No.	specification	
33154	130 x 270 mm G-17 handle	12

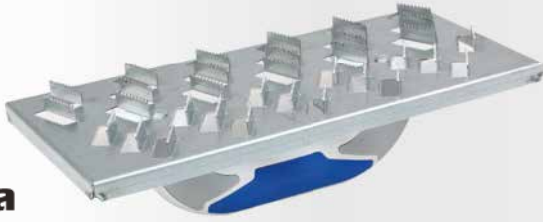

Kubala
BAR TROWEL

Zn

No.	specification	MOQ
32328	285 x 145 mm	10



Kubala
TROWEL FOR SANDING GRID

No.	specification	MOQ
33160	105 x 210 mm with rubber layer	20

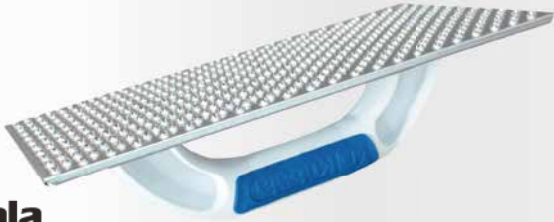

Kubala
GRINDING TROWEL

INOX

No.	specification	MOQ
33162	130 x 270 mm	20
33163	180 x 400 mm	10
33164	160 x 380 mm	10



Kubala
GRINDING TROWEL

No.	specification	MOQ
33165	165 x 365 mm	10



Kubala
GRINDING TROWEL

Kubala
GRINDING TROWEL

No.	specification	MOQ
33169	160 x 380 mm perforated, G-16 handle	10

No.	specification	MOQ
33167	130 x 270 mm G-17 handle	20
33168	160 x 380 mm G-17 handle	10
33170	180 x 400 mm G-17 handle	10



Kubala
STAINLESS SPATULA

INOX

No.	specification	
33200	40 mm	20
33201	60 mm	20
33202	80 mm	20
33203	100 mm	20



Kubala
STAINLESS SPATULA

INOX

No.	specification	
33205	130 x 90 mm	20



Kubala
STAINLESS SPATULA

INOX

No.	specification	
33206	130 x 37 mm	20



Kubala
STAINLESS SPATULA

INOX

No.	specification	
33207	150 mm with screwdriver	30



Kubala
STAINLESS SPATULA

INOX

No.	specification	
33208	350 x 90 mm	10



Kubala
STAINLESS SPATULA

INOX

No.	specification	
33209	335 x 37 mm	20



Kubala
STAINLESS SPATULA

INOX

No.	specification	
33210	150 mm G-15 handle	10
33211	250 mm G-15 handle	10
33212	350 mm G-15 handle	10



Kubala
STAINLESS SPATULA

INOX

No.	specification	
33215	600 mm AL, G-14 handle	10



Kubala
PLASTIC SPATULA

No.	specification	
33220	145 mm with rubber	10



Kubala
PLASTIC SPATULA

No.	specification	
33221	245 mm with rubber	10



Kubala
PLASTIC TROWEL, RUBBER

No.	specification	
33155	95 x 240 mm with rubber layer	5



Kubala
TILING SET

No.	specification	
33250		1



Kubala
BUCKET

No.	specification	
33254	16 l grid and wheels	1
33255	20 l grid and wheels	1



Kubala
TILING SET MINI

No.	specification	
33252		1



Kubala
PARTS FOR WASHING SETS

No.	specification	
33257	triple roller for bucket	1



Kubala
PARTS FOR WASHING SETS

No.	specification	
33256	roller for bucket	1
33258	roller for bucket	1



Kubala
SPACERS SMART LEVEL

leveling wedges 33246, 33247

100x

No.	specification	
33247	1 mm	15
33248	2 mm	15
33249	3 mm	15

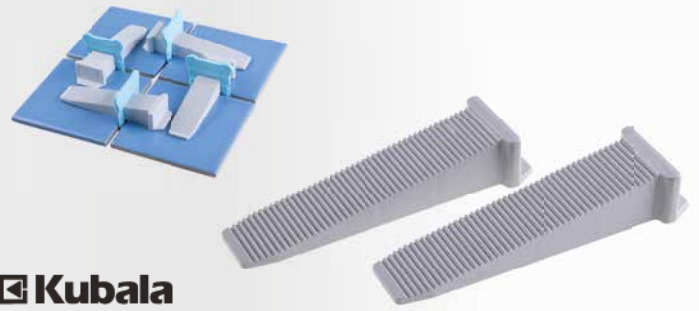

Kubala
LEVELING WEDGES

50x

No.	specification	
33246	Smart Level	15



Kubala
DIPPER PLASTIC

No.	specification	
33270	175 mm	20



Kubala
RUBBER BOWL

No.	specification	
33275	0,5 l	20



Kubala
RUBBER SPATULA

No.	specification	
33280	200 mm	10
37010	135 mm	20



Kubala
LEVELING ROLLER

No.	specification	
33289	85 x 230 mm	15



Kubala
PAINT SCRAPER

No.	specification	
33285	60 mm	1
33286	spare blade 60 mm	1



Kubala
DRILL FOR POROUS

No.	specification	
33291	60 mm	1
33292	80 mm	1
33293	120 mm	1



Kubala
PLASTIC MITER BOX

No.	specification	
33298	250 x 80 x 50 mm	1
33299	300 x 115 x 65 mm	1





AUTOMOTIVE 432 - 443





HYDRAULIC BOTTLE JACK, ONE PISTON

- extension screw allows low pickup height adjustment and maximum lift
- double safety bypass valve
- serrated saddle provides generous lifting area and secure grip
- a wide base provides stability and strength
- all models critical stress points are reinforced for added durability and dependability



No.	specification	capacity	min. height	lift	adjust height	base dimensions	Weight	
26800	Hydraulic bottle jack	2 000 kg	181mm	116 mm	48 mm	88 x 92 mm	2,6 kg	1
26801	Hydraulic bottle jack	3 000 kg	194 mm	118 mm	60 mm	92 x 100 mm	3,3 kg	1
26802	Hydraulic bottle jack	5 000 kg	216 mm	127 mm	70 mm	96 x 112 mm	4,5 kg	1
26803	Hydraulic bottle jack	8 000 kg	230 mm	147 mm	80 mm	103 x 118 mm	5,7 kg	1
26804	Hydraulic bottle jack	10 000 kg	230 mm	150 mm	80 mm	110 x 123 mm	6,8 kg	1
26805	Hydraulic bottle jack	12 000 kg	230 mm	155 mm	80 mm	116 x 134 mm	7,3 kg	1
26806	Hydraulic bottle jack	15 000 kg	230 mm	150 mm	80 mm	133 x 136 mm	8,4 kg	1
26807	Hydraulic bottle jack	20 000 kg	242 mm	150 mm	60 mm	144 x 152 mm	11 kg	1

HYDRAULIC BOTTLE JACK, DOUBLE PISTON

- extension screw allows low pickup height adjustment and maximum lift.
- double safety bypass valve.
- serrated saddle provides generous lifting area and secure grip.
- a wide base provides stability and strength
- all models critical stress points are reinforced for added durability and dependability.



No.	specification	capacity	min. height	lift	adjust height	Weight	
26815	Hydraulický zvedák teleskopický	2 000 kg	150 mm	160 mm	60 mm	4,7 kg	1
26816	Hydraulický zvedák teleskopický	4 000 kg	160 mm	170 mm	60 mm	6,4 kg	1
26817	Hydraulický zvedák teleskopický	6 000 kg	215 mm	270 mm	-	8,9 kg	1
26819	Hydraulický zvedák teleskopický	10 000 kg	228 mm	284 mm	89 mm	10,2 kg	1



SCISSORS JACK



No.	specification	capacity	min. height	max. height	Weight	
26844	Scissors Jack	1 000 kg	88 mm	380 mm	2,5 kg	1
26845	Scissors Jack	2 000 kg	120 mm	395 mm	3,5 kg	1



HYDRAULIC LIFTING JACK



No.	specification	capacity	min. height	max. height	Weight	
26820	Hydraulic trolley jack 2t, portable	2 000 kg	130 mm	345 mm	9,6 kg	1
26826	Hydraulic garage jack, low profil, 360° rotating handle	2 000 kg	89 mm	359 mm	14,2 kg	1
26824	Hydraulic garage jack, foot handle	3 000 kg	145 mm	500 mm	37,2 kg	1
26825	Hydraulic garage jack, low profil, profi	2 500 kg	85 mm	455 mm	34,8 kg	1



HYDRAULIC TROLLEY JACK + JACK STANDS

- 360° rotating handle



No.	specification	capacity	min. height	max. height	Weight	
26829	Hydraulic trolley jack	2 000 kg	130 mm	350 mm	10,5 kg	1
	2pcs jack stands	2 000 kg	275 mm	420 mm	5 kg (pair)	



JACK STAND

- 1pc = 1pair
- ratchet type for fine adjustable with double locking protection
- solid steel handle
- large saddle, unitized frame construction
- ductile iron rack



No.	specification	capacity	min. height	max. height	Weight	
26857	Jack stand - pair; with lock pin	2 000 kg	275 mm	420 mm	4,8 kg	1
26858	Jack stand - pair; with lock pin	3 000 kg	285 mm	425 mm	6,3 kg	1
26859	Jack stand - pair; with lock pin	6 000 kg	393 mm	593 mm	13 kg	1
26853	Jack stand - pair	12 000 kg	465 mm	715 mm	28 kg	1



HYDRAULIC CRANE JACK, FOLDABLE

- for lifting and fixing units during its mounting and demounting from cars
- crane boom has a few position of extension
- the crane can easily be folded for storage



No.	specification	capacity	min. height	max. height	Weight	
26862	Hydraulic crane jack, foldable	2 000 kg	0	2360 mm	88 kg	1



ENGINE SUPPORT

- swinging suspension of the arm, depends on the cowl slope, ensuring always balanced and stable engine fixing

No.	specification	capacity	length	range	Weight	
26871	Engine leveler	500 kg	1500 mm	150 mm	20,3 kg	1

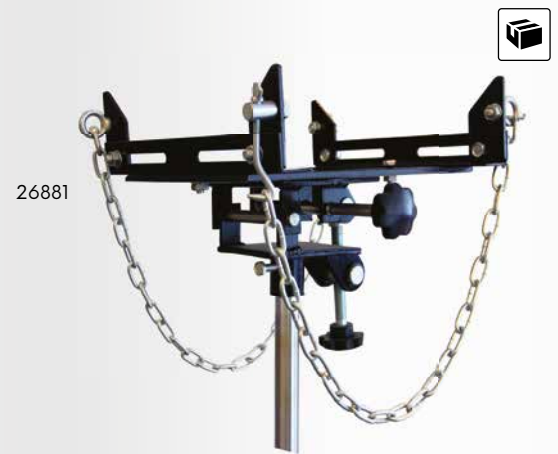

HYDRAULIC TRANSMISSION JACK

- easy mounting and demounting units (engines, transmissions, axles etc.)

No.	specification	capacity	length	range	Weight	
26880	Hydraulic transmission jack	500 kg	1100 mm	1900 mm	30,0 kg	1
26881	Automatic transmission jack extension	500 kg	1100 mm	1900 mm	15,0 kg	1



PORTABLE HYDRAULIC EQUIPMENT

- hydraulic equipment for repairing vehicle bodies
- it's provided with piston cylinder and 14 pcs accessories
- it is widel applicable to repair car and truck bodies, especially to field work without power suply
- during its use, the accessories can push, pull, lift and extend in vertical and horizontal directions
- easy transporting in blow mold case

No.	specification	capacity	hydraulic lift	Weight	
26886	Portable hydraulic equipment	4 000 kg	125 mm	17,0 kg	1
26888	Portable hydraulic equipment	10 000 kg	135 mm	32,0 kg	1



26920



26921



26922

ENGINE STAND

- movable stand for mounting and working on demounted engines
- universal clamping unit for fastening the engine and its rotating



No.	specification	capacity	Weight	
26920	Engine stand, positioning, mobile	450 kg	20 kg	1
26921	Engine stand, positioning, mobile	560 kg	27 kg	1
26922	Engine stand, positioning, mobile, foldable	675 kg	35 kg	1

HAND WINCH

Zn

- high quality zinc-coated winch with durable wire rope



No.	specification	Cable diameter	max. Capacity	Cable length	
26705	Hand winch	4,0mm	450 kg	10 m	1
26706	Hand winch	5,0mm	900 kg	10 m	1
26707	Hand winch	6,0mm	1350 kg	10 m	1
26720	Hand winch	4,0mm	300 kg	10 m	1
26721	Hand winch	4,0mm	500 kg	10 m	1
26722	Hand winch	5,0mm	800 kg	10 m	1

CHAIN JACK



No.	specification	Capacity	Min. height	Lift height	No. of chain block.	Chain Thickness	Weight	
26700	Chain jack	500 kg	280 mm	3 000 mm	1	6 mm	7,5 kg	1
26701	Chain jack	1 000 kg	300 mm	3 000 mm	1	6 mm	9 kg	1
26702	Chain jack	2 000 kg	380 mm	3 000 mm	2	6 mm	12 kg	1



SPRING COMPRESSOR

· 26897 - to replace mcpherson struts/springs directly in the car.

· 26943 - to replace mcpherson struts/springs outside the vehicle rugged steel profiles for higher stability.



No.	specification	Capacity	Ø Compressed Spring.	Compression Length	Weight	
26897	Portable spring compressor	1 000 kg	100-200 mm	150 mm	24,5 kg	1
26943	Spring compressor	1 000 kg	400 mm	210-570 mm	35 kg	1



HYDRAULIC SHOP PRESS



No.	specification	Range	Max.Capacity	Weight	
26940	Hydraulic shop press	0 - 610 mm	12 000 kg	43 kg	1
26941	Hydraulic shop press	0 - 880 mm	20 000 kg	75 kg	1

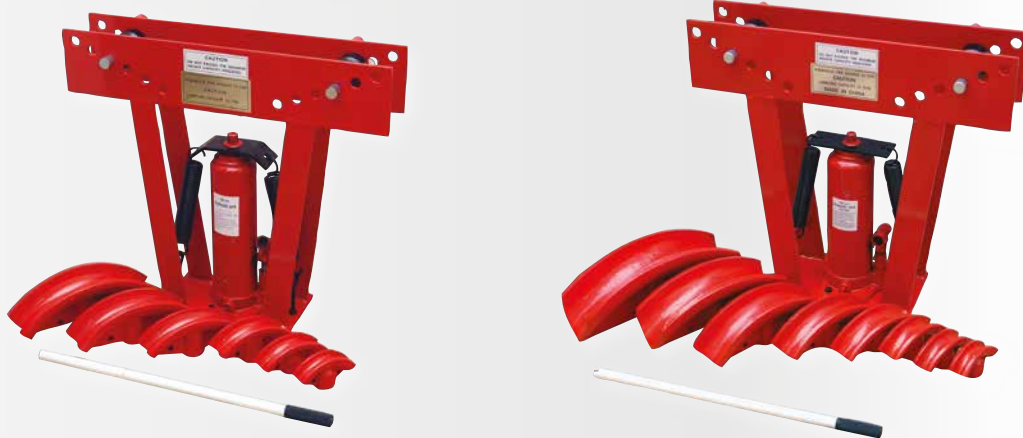

HYDRAULIC PIPE BENDER



No.	specification	Capacity	Lift heigh	Bending shoes	Weight	
26895		12 000 kg	232 mm	1½", 3¼", 1", 1-1¼", 1-1½", 2"	36 kg	1
26896		16 000 kg	238 mm	1½", 3¼", 1", 1-1¼", 1-1½", 2", 2-1½", 3"	65 kg	1



HYDRAULIC LONG RAM



No.	specification	Capacity	Min.Length (mm)	Max. Length (mm)	Weight	
26911	Hydraulic long ram, single pump	5 000 kg	620	1100	12 kg	2
26912	Hydraulic long ram, single pump	8 000 kg	620	1100	13 kg	2
26914	Hydraulic long ram, double pump	5 000 kg	620	1100	12 kg	2
26915	Hydraulic long ram, double pump	8 000 kg	620	1100	14 kg	2



PARTS WASHER

· for common object washing (parts, accessories etc.)



No.	specification	Tank capacity	Solvent capacity	Flow rate	Max. solvent temperature	Weight	
26961	Parts washer	90 l	45 l	10-12 l/min.	50°C	25 kg	1
26963	Parts washer	180l	150 l	20 l/min	50°C	42 kg	1

WASTE OIL EXTRACTOR

- oil is drained from engine to collector through the dish
- collector is fitted with extraction equipment
- oil can be pumped from the collector with pressure air through a hose



No.	Cubage	Max.Pressure	Weight	
26954	90 l	0,5 MPa	28 kg	1



TWO - LEG PULLER



No.	max. diameter	depth	
23734	Ø 100 mm	50-95 mm	1
23735	Ø 150 mm	100-150 mm	1
23736	Ø 200 mm	110-190 mm	1

THREE - LEG PULLER



No.	max. diameter	depth	
23730	Ø 100 mm	50-95 mm	12
23731	Ø 150 mm	100-150 mm	2
23732	Ø 200 mm	110-190 mm	2

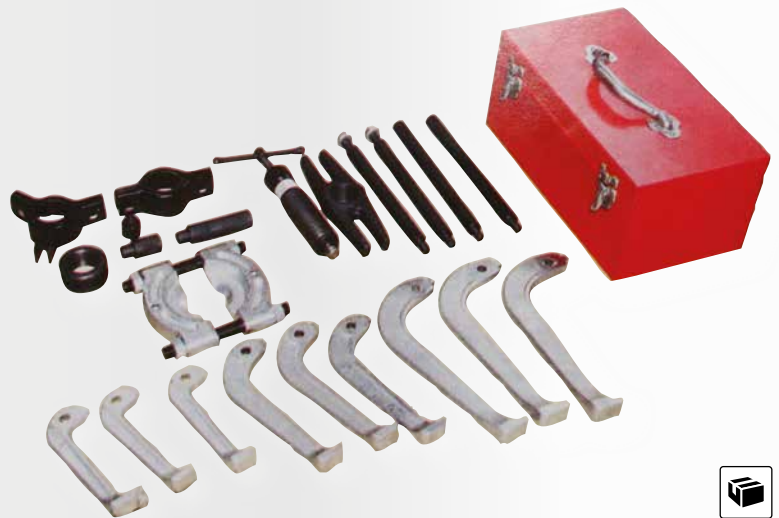

HYDRAULIC PULLER

· hydraulic puller set. including hydraulic screw, full jaws as well as 3 triplets of arms and spans in steel case

No.	specification	Capacity	Weight	
26891	Universal hydraulic puller set	12 000 kg	18 kg	1



SPARE PARTS FOR SANDBLASTING CABINET

No.	specification	
26973	gloves	1
26974	nozzles	1
26975	foil 53,5 x 26 cm	1
26976	plexiglass 60 x 30 cm	1
26977	glass 60 x 30 cm	1

SANDBLASTING CABINET



No.	Air consumption	Outside dimensions	Inside dimensions	Max. Pressure	Weight	
26972	420-710 l/min.	1500 x 830 x 630 mm	600 x 840 x 630 mm	8 bar	38 kg	1



FESTA

TOOL CABINET

No.	Drawers slides	Drawers	Overall dimensions (mm)	
26986	smooth	7	680 x 460 x 1020 mm	1



TOOL CABINET

· top chest can be put into roller cabinet

No.	specification	Drawers slides	Drawers	Drawers inside dimensions WxDxH (mm)	Overall dimensions (mm)	Total weight (kg)	
26985	top case	smooth	3	151,5 x 225 x 40 mm	600 x 260 x 340 mm	11,5 kg	1
			2	511 x 225 x 40 mm			
	bottom case	smooth	1	511 x 225 x 85 mm	616 x 330 x 742 mm	16,4 kg	
			2	511 x 308 x 85 mm			



MAGNETIC TRAY



No.	Specification	
26996	200 x 20 mm	1



TIGHTENING EQUIPMENT



No.	Specification	
50035	2 t	6
50036	4 t	4



KNEELING CREEPER

No.	
37135	1



CAR CREEPER

padded roller seat with plastic tool tray.

No.	Specification	
26988	360 x 365 x 365 mm	1



MINI ENGINE HOIST

No.	
26998	1

number of item	page	number of item	page	number of item	page	number of item	page	number of item	page	number of item	page
10002	26	12020	31	13275	51	13452	32	14077	35	15230	40
10003	26	12030	31	13276	52	13453	32	14080	34	15235	40
10005	26	12050	31	13277	55	13454	32	14090	35	15310	40
10008	26	12110	31	13278	51	13455	32	14091	35	15315	40
10025	26	12120	31	13279	50	13456	32	14220	36	15318	40
10033	26	12130	31	13280	51	13457	32	14225	36	15320	40
10035	26	12150	31	13281	55	13458	32	14230	36	15325	40
10043	26	12210	31	13282	55	13459	32	14235	36	15330	40
10045	26	12220	31	13284	50	13460	32	14240	36	15335	40
10048	26	12230	31	13285	55	13461	32	14250	36	15340	40
10110	27	12250	31	13290	92	13462	32	14350	36	15415	41
10120	27	12433	31	13293	92	13463	32	14360	36	15418	41
10130	27	12435	31	13294	92	13464	32	14370	36	15420	41
10330	27	13010	32	13295	57	13465	32	14380	36	15425	41
10332	27	13020	32	13296	57	13466	32	14399	36	15430	41
10334	27	13021	32	13350	56	13467	32	14410	37	15510	41
10336	27	13022	32	13351	56	13468	32	14411	37	15515	41
10430	27	13023	32	13352	56	13469	32	14415	36	15518	41
10450	27	13111	32	13353	56	13470	32	14417	36	15520	41
10490	27	13120	32	13354	56	13471	32	14420	36	15525	41
10996	27	13205	54	13355	56	13472	32	14421	36	15530	41
10998	27	13206	54	13360	56	13473	32	14425	37	15535	41
10999	27	13207	54	13361	56	13500	30	14430	37	15540	41
11002	29	13208	54	13362	56	13501	30	14435	37	15615	41
11003	29	13210	32	13363	56	13502	30	14440	37	15620	41
11005	29	13211	32	13364	56	13503	30	14450	37	15625	41
11006	29	13212	54	13365	56	13504	30	14451	37	15630	41
11007	29	13214	53	13399	33	13505	30	14455	37	15710	41
11008	29	13216	53	13400	33	13506	30	14456	37	15715	41
11082	29	13217	53	13401	32	13507	30	14457	37	15720	41
11083	29	13218	53	13402	32	13508	30	14458	37	15725	41
11085	29	13219	53	13403	32	13509	30	14471	37	15730	41
11102	29	13220	32	13404	32	13510	30	14472	37	15735	41
11103	29	13222	53	13405	32	13511	30	14473	37	15740	41
11105	29	13223	53	13406	32	13512	30	14474	37	15810	42
11106	29	13224	53	13407	32	13513	30	14480	35	15812	42
11107	29	13225	53	13408	32	13514	30	14485	37	15815	42
11110	29	13226	53	13409	32	13515	30	14485	42	15818	42
11200	29	13227	53	13410	32	13516	30	14486	37	15820	42
11201	29	13228	53	13411	32	13517	30	14486	42	15825	42
11202	29	13229	53	13412	32	13518	30	14490	37	15830	42
11204	29	13230	53	13413	32	13519	30	14491	37	15850	42
11205	29	13231	53	13414	32	13520	30	14492	37	15853	42
11206	29	13235	53	13415	32	13521	30	14493	37	15855	42
11207	29	13236	53	13416	32	13522	30	14494	37	15860	42
11208	29	13237	53	13417	32	13523	30	15003	39	15870	42
11209	29	13238	53	13418	32	13524	30	15004	39	15880	42
11210	29	13240	55	13419	32	13525	30	15005	39	15885	259
11220	28	13241	55	13420	32	13526	30	15006	39	15886	259
11221	28	13242	55	13421	32	13527	30	15008	39	15886	383
11226	28	13243	55	13422	32	13528	30	15010	39	15887	259
11239	28	13244	55	13423	32	13529	30	15012	39	15887	383
11259	28	13245	55	13424	32	13530	30	15015	39	15888	259
11260	28	13246	54	13425	32	13531	30	15018	39	15888	383
11311	30	13249	56	13426	32	13532	30	15020	39	15889	259
11312	30	13250	56	13427	32	13533	30	15033	38	15904	43
11313	30	13251	56	13428	32	13534	30	15034	38	15906	43
11314	30	13252	56	13429	32	14001	34	15035	38	15908	43
11323	28	13253	56	13430	32	14002	34	15036	38	15910	43
11325	28	13254	56	13431	32	14003	34	15037	38	15912	43
11327	28	13255	57	13432	32	14004	34	15039	38	15915	43
11333	29	13256	57	13433	32	14006	34	15103	39	15920	43
11335	29	13257	57	13434	32	14007	34	15104	39	15954	43
11337	29	13258	57	13435	32	14008	34	15105	39	15956	43
11338	29	13259	57	13436	32	14009	34	15106	39	15958	43
11343	28	13260	55	13437	32	14010	33	15108	39	15960	43
11345	28	13261	52	13438	32	14011	33	15110	39	15962	43
11347	28	13262	50	13439	32	14012	33	15112	39	15965	43
11353	28	13263	50	13440	32	14013	34	15115	39	15970	43
11355	28	13264	51	13441	32	14015	33	15118	39	15980	44
11356	28	13265	50	13442	32	14017	33	15120	39	15981	44
11358	28	13266	50	13443	32	14019	33	15204	40	15983	31
11360	28	13267	50	13444	32	14025	37	15205	40	15985	31
11410	30	13268	51	13445	32	14030	33	15206	40	15988	31
11416	29	13269	50	13446	32	14035	34	15208	40	15989	31
11420	30	13270	50	13447	32	14040	34	15210	40	15990	44
11425	30	13271	50	13448	32	14045	34	15212	40	15991	44
11444	30	13272	51	13449	32	14060	35	15215	40	15992	44
11445	30	13273	51	13450	32	14070	35	15218	40	15993	44
12010	31	13274	52	13451	32	14075	35	15220	40	15996	42

LIST OF ITEMS



number of item	page	number of item	page	number of item	page	number of item	page	number of item	page	number of item	page
15997	42	16085	167	16991	177	17083	69	17211	73	17351	114
15998	42	16086	167	16991	344	17084	66	17212	74	17352	114
15999	42	16090	165	16998	163	17085	66	17213	74	17353	114
16002	162	16091	165	16999	163	17086	66	17214	74	17357	114
16003	162	16095	167	17001	62	17089	70	17215	74	17359	114
16004	163	16100	164	17002	62	17090	70	17216	75	17360	114
16005	163	16105	164	17003	62	17091	70	17217	75	17361	114
16006	163	16110	164	17004	62	17092	70	17218	75	17380	85
16010	163	16115	164	17005	62	17093	70	17219	75	17381	85
16010	163	16120	164	17006	62	17094	62	17220	77	17382	85
16011	162	16125	164	17007	62	17095	62	17222	77	17383	85
16011	162	16130	166	17008	62	17096	62	17224	77	17384	85
16011	163	16131	164	17009	62	17097	62	17225	76	17385	85
16012	162	16135	166	17010	62	17098	62	17226	76	17386	85
16012	162	16136	165	17011	62	17099	62	17227	76	17390	86
16012	163	16137	165	17012	66	17100	62	17229	78	17391	86
16013	163	16140	166	17013	66	17101	61	17230	79	17392	86
16013	163	16141	169	17014	66	17102	61	17231	79	17393	86
16016	163	16142	165	17015	69	17103	61	17233	79	17394	86
16017	163	16143	165	17016	69	17104	61	17234	79	17395	86
16019	162	16144	165	17017	69	17105	61	17235	80	17396	86
16021	169	16145	165	17019	69	17108	62	17236	80	17397	86
16022	173	16146	166	17020	68	17109	65	17237	80	17398	86
16023	167	16147	166	17021	68	17110	62	17238	110	17400	86
16024	169	16150	164	17022	68	17111	70	17238	78	17401	85
16025	166	16151	164	17023	65	17112	70	17240	81	17402	85
16026	169	16198	176	17024	62	17116	70	17241	81	17405	85
16028	169	16199	176	17025	64	17117	70	17242	81	17406	85
16029	166	16201	173	17026	179	17121	70	17243	81	17407	85
16030	168	16202	63	17027	179	17122	70	17244	81	17410	85
16031	168	16209	175	17028	68	17125	63	17245	78	17411	85
16032	168	16210	174	17029	68	17126	63	17247	111	17412	85
16033	168	16211	174	17033	66	17127	63	17250	77	17413	85
16034	166	16212	173	17034	65	17128	63	17255	77	17414	85
16035	168	16218	174	17035	65	17130	63	17259	111	17415	85
16036	168	16219	174	17036	65	17133	63	17260	110	17416	85
16037	167	16220	174	17037	179	17135	63	17261	91	17420	85
16038	168	16221	174	17038	69	17137	63	17262	91	17421	85
16041	168	16222	175	17039	68	17138	63	17292	81	17422	85
16042	170	16223	175	17040	64	17140	61	17294	81	17427	85
16042	284	16224	175	17041	64	17142	61	17295	81	17450	91
16043	169	16225	173	17042	64	17145	61	17296	81	17451	91
16046	169	16226	175	17043	64	17146	61	17297	81	17455	86
16049	170	16227	175	17044	64	17148	61	17298	81	17456	86
16050	170	16228	175	17045	64	17155	71	17299	81	17458	86
16051	170	16229	173	17046	68	17156	71	17300	69	17459	86
16052	170	16230	173	17047	64	17158	72	17301	69	17460	88
16053	169	16231	127	17048	68	17159	72	17302	69	17461	88
16054	170	16231	173	17050	72	17160	72	17303	69	17462	88
16055	169	16232	65	17050	179	17165	71	17304	69	17463	88
16056	284	16232	176	17051	68	17167	71	17305	69	17464	88
16057	167	16234	173	17052	68	17169	71	17306	69	17465	88
16058	167	16235	174	17053	68	17170	71	17308	82	17466	88
16059	170	16236	174	17054	68	17175	71	17309	82	17467	88
16060	172	16281	177	17055	68	17177	71	17310	82	17468	88
16061	172	16282	177	17056	68	17180	63	17311	82	17469	88
16062	171	16300	180	17057	68	17181	63	17312	82	17470	88
16063	171	16301	180	17058	68	17182	178	17313	82	17471	88
16064	171	16303	180	17059	66	17183	178	17314	82	17472	88
16065	171	16304	180	17060	66	17185	72	17315	82	17473	88
16066	164	16310	180	17061	66	17186	71	17316	82	17475	89
16066	171	16310	180	17062	66	17187	139	17317	82	17476	89
16067	171	16311	180	17063	67	17188	139	17318	82	17480	88
16068	171	16311	180	17064	67	17189	139	17319	82	17481	88
16069	170	16311	180	17065	67	17190	64	17320	82	17482	88
16070	170	16312	180	17066	67	17191	64	17321	82	17483	88
16070	172	16312	180	17067	67	17192	64	17322	82	17484	88
16071	167	16315	179	17068	67	17193	64	17324	82	17485	88
16071	172	16315	179	17069	67	17197	88	17327	82	17486	88
16072	172	16320	180	17070	67	17198	88	17330	82	17487	87
16073	172	16321	143	17071	67	17199	88	17332	82	17488	87
16074	167	16321	180	17072	67	17200	88	17333	82	17489	87
16074	172	16401	72	17075	67	17201	88	17334	82	17490	87
16075	172	16405	72	17076	67	17202	88	17335	77	17491	87
16077	171	16406	72	17077	67	17203	91	17336	77	17492	87
16078	171	16407	72	17078	69	17204	91	17337	77	17493	87
16081	171	16408	72	17079	66	17205	91	17338	77	17494	87
16082	170	16420	72	17080	66	17206	91	17345	76	17495	87
16083	172	16990	177	17081	66	17208	77	17346	76	17496	87
16084	172	16990	344	17082	66	17210	73	17350	114	17501	90

number of item	page	number of item	page	number of item	page	number of item	page	number of item	page	number of item	page
17506	89	17631	87	17851	83	18066	94	18416	99	18607	106
17508	89	17632	87	17852	83	18067	94	18417	99	18608	98
17512	89	17633	87	17853	83	18070	94	18418	97	18610	106
17526	89	17640	90	17854	83	18071	94	18419	99	18611	106
17528	89	17642	90	17855	83	18072	94	18420	99	18612	106
17532	89	17643	90	17856	83	18075	94	18421	109	18613	106
17533	89	17644	90	17860	82	18076	94	18422	95	18614	106
17534	89	17645	90	17861	82	18077	94	18423	96	18615	106
17539	89	17650	90	17862	82	18080	94	18424	95	18618	106
17548	87	17651	90	17863	82	18081	94	18425	98	18619	105
17549	87	17652	90	17864	82	18082	94	18426	96	18619	86
17550	87	17653	90	17865	82	18083	94	18430	109	18620	103
17551	87	17654	90	17866	82	18084	94	18431	99	18621	103
17552	87	17655	90	17867	82	18085	94	18433	98	18623	103
17553	87	17656	90	17868	82	18086	94	18435	100	18625	103
17554	87	17657	90	17869	82	18087	94	18437	96	18627	103
17555	87	17658	90	17870	82	18088	94	18440	109	18628	103
17556	87	17659	90	17871	82	18089	94	18450	98	18630	103
17557	87	17660	87	17872	82	18090	94	18451	98	18631	103
17558	87	17661	87	17873	82	18091	94	18455	94	18632	103
17559	87	17662	87	17874	82	18092	94	18456	94	18632A	102
17560	87	17663	87	17875	82	18101	97	18460	94	18633	103
17561	87	17664	87	17876	82	18102	97	18466	113	18633A	102
17562	87	17665	87	17877	82	18103	97	18468	113	18634	103
17563	87	17666	87	17878	82	18104	97	18476	113	18635	103
17564	87	17667	87	17879	82	18105	97	18477	113	18636	103
17565	87	17668	87	17880	82	18106	97	18490	112	18636A	102
17566	87	17669	87	17881	82	18107	97	18491	112	18637	103
17567	87	17670	87	17882	82	18108	97	18492	112	18637A	102
17568	87	17671	87	17883	82	18110	98	18493	112	18638	103
17569	87	17672	87	17884	82	18113	93	18494	114	18638A	102
17570	87	17674	87	17885	82	18114	93	18495	114	18639	103
17571	87	17675	87	17886	82	18115	93	18496	112	18640	103
17572	87	17676	87	17887	82	18116	93	18497	112	18641	103
17573	87	17677	87	17888	82	18118	93	18498	112	18645	103
17574	87	17678	87	17889	82	18120	93	18499	114	18646	103
17575	87	17679	87	17890	82	18124	93	18500	112	18680	103
17576	87	17680	90	17891	82	18125	93	18508	113	18685	103
17577	87	17681	90	17892	82	18201	97	18510	113	18750	103
17578	87	17682	90	17895	83	18202	97	18511	113	18751	103
17579	87	17683	87	17896	83	18203	97	18512	113	18753	103
17580	87	17685	88	17897	83	18204	97	18513	113	18755	103
17581	87	17761	88	17898	83	18210	93	18514	113	18760	103
17582	87	17769	88	17902	83	18211	93	18515	113	18761	103
17583	87	17788	88	17904	83	18212	93	18516	113	18762	103
17584	87	17789	88	17905	83	18215	93	18518	113	18763	103
17585	87	17795	88	17907	83	18216	93	18519	113	18764	103
17586	87	17806	88	17910	83	18301	97	18520	113	18765	103
17587	87	17810	82	17912	83	18302	97	18521	113	18766	103
17589	87	17811	82	17913	83	18303	97	18522	113	18767	103
17590	87	17812	82	17914	83	18304	97	18523	113	18768	103
17591	87	17820	82	17916	83	18310	93	18524	113	18769	103
17592	87	17821	82	17922	83	18311	93	18527	113	18770	103
17593	87	17822	82	17924	83	18312	93	18548	113	18771	103
17600	91	17823	82	17925	83	18313	93	18559	113	18772	103
17601	91	17824	82	17926	83	18321	93	18562	113	18775	103
17603	91	17825	82	17927	83	18322	93	18567	113	18776	103
17605	88	17826	82	17930	83	18340	95	18572	113	18777	103
17606	88	17827	82	17931	83	18350	94	18575	113	18795	105
17607	88	17828	82	17932	83	18351	94	18576	113	18796	105
17608	88	17829	82	17933	83	18352	94	18577	113	18797	105
17609	88	17830	82	17934	83	18353	94	18578	113	18798	105
17610	88	17831	82	17935	83	18354	94	18579	113	18799	106
17611	88	17832	82	17943	83	18355	94	18580	113	18800	104
17612	88	17835	83	17944	83	18356	94	18581	113	18801	104
17613	88	17836	83	17970	104	18357	94	18582	113	18802	104
17614	88	17837	83	17971	104	18358	94	18583	113	18803	104
17615	88	17838	83	17972	104	18359	94	18584	113	18804	104
17616	88	17839	83	17973	104	18360	94	18585	113	18805	104
17617	88	17840	83	17974	104	18400	97	18586	113	18806	104
17620	90	17841	83	17975	104	18401	97	18587	113	18807	104
17621	90	17842	83	17976	104	18402	95	18588	113	18810	104
17622	87	17843	83	17980	104	18403	95	18589	113	18811	104
17623	87	17844	83	17981	104	18404	95	18593	113	18812	104
17624	87	17845	83	17982	104	18408	100	18600	105	18813	104
17625	87	17846	83	17983	104	18409	100	18601	105	18814	104
17626	87	17847	83	18062	94	18410	96	18602	106	18815	104
17628	87	17848	83	18063	94	18411	96	18603	81	18816	104
17629	87	17849	83	18064	94	18413	96	18604	86	18817	104
17630	87	17850	83	18065	94	18415	99	18605	106	18820	104

LIST OF ITEMS



number of item	page	number of item	page	number of item	page	number of item	page	number of item	page	number of item	page
18821	104	18957	84	19115	142	19410	126	19537	185	19607	185
18822	104	18960	84	19124	118	19410	202	19538	185	19608	185
18823	104	18961	84	19136	118	19411	126	19539	185	19609	185
18824	104	18963	84	19148	118	19411	202	19540	185	19610	185
18825	104	18971	84	19149	118	19412	126	19540	185	19610	185
18826	104	18993	107	19150	117	19412	202	19541	185	19611	185
18827	104	18994	107	19151	117	19415	125	19542	185	19612	185
18827A	102	19001	116	19200	120	19416	125	19543	185	19613	185
18828	104	19002	116	19202	120	19418	126	19544	185	19614	185
18828A	102	19003	116	19208	121	19418	202	19545	185	19615	185
18829	104	19004	116	19209	121	19419	126	19545	185	19615	185
18830	104	19005	116	19211	121	19419	202	19546	185	19616	185
18830A	102	19006	116	19245	120	19421	125	19547	185	19617	185
18831	104	19008	116	19246	120	19422	125	19548	185	19618	185
18831A	102	19010	116	19247	120	19423	125	19550	185	19619	185
18832	104	19015	116	19248	120	19424	125	19550	185	19620	185
18835	104	19020	116	19249	120	19425	125	19552	185	19620	185
18836	104	19021	116	19251	121	19426	125	19552	185	19621	185
18837	104	19022	116	19252	121	19427	125	19553	185	19622	185
18838	104	19023	116	19253	121	19429	202	19554	185	19623	185
18839	104	19024	116	19254	120	19430	119	19555	185	19624	185
18840	104	19025	116	19255	120	19431	119	19555	185	19625	185
18841	104	19026	116	19265	120	19432	119	19556	185	19625	185
18842	104	19028	116	19270	120	19433	119	19557	185	19626	185
18843	104	19030	116	19271	120	19434	119	19558	185	19627	185
18844	104	19031	116	19272	120	19435	119	19558	185	19628	185
18845	104	19032	116	19290	120	19436	126	19559	185	19629	185
18846	104	19034	116	19293	120	19436	202	19560	185	19630	185
18847	104	19036	116	19294	120	19440	119	19560	185	19630	185
18850	104	19041	115	19295	120	19441	119	19561	185	19631	185
18851	104	19042	115	19297	121	19442	119	19562	185	19632	185
18852	104	19043	115	19301	123	19443	119	19562	185	19633	185
18853	104	19044	115	19303	118	19450	127	19563	185	19634	185
18855	104	19045	115	19306	123	19451	127	19564	185	19635	185
18856	104	19046	115	19308	123	19455	127	19565	185	19635	185
18860	104	19050	116	19310	123	19457	127	19565	185	19636	185
18861	104	19051	118	19312	123	19458	128	19567	185	19637	185
18862	104	19052	118	19314	123	19459	128	19568	185	19638	185
18863	104	19053	116	19326	123	19460	126	19568	185	19639	185
18864	104	19054	116	19328	123	19462	124	19569	185	19640	185
18865	104	19055	116	19330	123	19463	124	19570	185	19640	185
18866	104	19056	116	19332	123	19464	124	19570	185	19641	185
18867	104	19057	116	19333	123	19465	124	19573	185	19642	185
18868	105	19058	116	19335	123	19469	124	19574	185	19643	185
18869	105	19059	116	19337	123	19470	126	19575	185	19644	185
18870	105	19060	118	19340	122	19472	203	19575	185	19645	185
18871	105	19061	117	19356	124	19473	203	19576	185	19645	185
18872	105	19062	117	19357	124	19474	203	19577	185	19646	185
18873	105	19063	117	19370	123	19477	203	19578	185	19647	185
18874	105	19064	117	19371	123	19478	203	19579	185	19648	185
18900	108	19065	118	19374	124	19480	203	19580	185	19649	185
18901	108	19066	116	19380	122	19481	203	19580	185	19650	185
18905	108	19067	116	19381	122	19482	203	19581	185	19650	185
18906	108	19068	116	19382	122	19483	203	19583	185	19651	185
18907	109	19069	116	19383	122	19485	202	19584	185	19652	185
18909	108	19070	116	19384	122	19486	202	19585	185	19653	185
18910	100	19071	116	19385	122	19487	202	19585	185	19654	185
18915	109	19074	115	19387	122	19490	127	19586	185	19655	185
18916	109	19075	115	19388	122	19491	127	19587	185	19656	185
18920	84	19076	115	19389	122	19492	127	19588	185	19657	185
18921	84	19077	115	19390	123	19493	127	19589	185	19658	185
18922	84	19081	115	19391	122	19494	127	19590	185	19659	185
18925	84	19082	115	19392	123	19495	127	19590	185	19660	185
18926	84	19083	115	19393	124	19496	127	19591	185	19661	185
18927	84	19084	115	19394	124	19497	127	19593	185	19662	185
18928	84	19085	115	19395	124	19498	127	19594	185	19663	185
18929	84	19086	115	19396	124	19499	127	19595	185	19664	185
18930	84	19088	115	19397	124	19501	127	19595	185	19665	185
18931	84	19090	115	19398	119	19502	127	19596	185	19669	185
18934	84	19092	115	19399	119	19510	128	19597	185	19670	186
18937	84	19095	115	19400	126	19515	128	19598	185	19671	186
18939	84	19096	115	19401	126	19520	128	19599	185	19672	186
18944	84	19097	115	19402	126	19530	185	19600	185	19673	186
18945	84	19098	115	19403	126	19530	185	19600	185	19673	186
18948	84	19100	117	19404	126	19532	185	19601	185	19674	186
18950	84	19106	115	19405	126	19533	185	19603	185	19675	186
18951	84	19108	115	19406	126	19534	185	19604	185	19676	186
18954	84	19109	115	19407	126	19535	185	19605	185	19677	186
18955	84	19110	128	19408	126	19535	185	19605	185	19678	186
18956	84	19115	118	19409	126	19536	185	19606	185	19678	186

number of item	page	number of item	page	number of item	page	number of item	page	number of item	page	number of item	page
19679	186	19743	186	20235	187	20493	191	20767	194	20942	197
19680	186	19743	186	20240	187	20494	191	20768	194	20943	197
19681	186	19744	186	20245	187	20495	191	20769	194	20944	197
19682	186	19745	186	20250	187	20496	191	20770	194	20945	197
19683	186	19746	186	20255	187	20508	195	20771	194	20946	197
19683	186	19747	186	20260	187	20510	195	20772	194	20947	197
19684	186	19748	186	20270	187	20511	195	20773	194	20948	197
19685	186	19748	186	20280	187	20512	195	20774	194	20949	197
19686	186	19749	186	20290	187	20513	195	20775	194	20950	196
19687	186	19750	186	20296	187	20514	195	20776	194	20952	196
19688	186	19751	186	20300	189	20515	195	20777	194	20954	196
19688	186	19752	186	20305	189	20516	195	20778	194	20956	197
19689	186	19753	186	20310	189	20520	195	20779	194	20957	204
19690	186	19753	186	20311	189	20521	195	20780	194	20958	204
19691	186	19754	186	20315	190	20522	195	20781	194	20960	209
19692	186	19755	186	20316	189	20523	195	20782	194	20961	209
19693	186	19756	186	20317	189	20524	195	20783	194	20963	209
19693	186	19757	186	20320	190	20525	195	20784	194	20965	209
19694	186	19758	186	20321	190	20526	195	20785	194	20966	209
19695	186	19758	186	20333	188	20673	194	20786	194	20967	90
19695	186	19759	186	20334	188	20674	194	20787	194	20968	90
19696	186	19760	186	20335	188	20675	194	20788	194	20969	90
19697	186	19761	186	20336	188	20676	194	20789	194	20970	209
19698	186	19762	186	20337	188	20677	194	20790	194	20971	209
19698	186	19763	186	20338	188	20678	194	20791	194	20972	209
19699	186	19763	186	20350	203	20680	194	20792	194	20973	209
19700	186	19764	186	20360	180	20682	194	20793	194	20980	204
19701	186	19765	186	20361	180	20684	194	20794	194	20981	204
19701	186	19766	186	20363	71	20685	194	20795	194	20982	204
19702	186	19767	186	20365	209	20686	194	20796	194	20983	204
19703	186	19768	186	20379	199	20687	194	20797	194	20984	204
19703	186	19768	186	20380	190	20688	194	20798	194	20990	197
19704	186	19769	186	20381	208	20690	194	20799	194	20991	197
19705	186	19770	186	20385	193	20691	194	20805	195	20992	197
19705	186	19771	186	20386	193	20692	194	20820	195	20999	195
19706	186	19772	186	20387	193	20694	194	20825	194	21010	236
19707	186	19772	186	20390	193	20696	194	20855	194	21011	236
19708	186	19773	186	20391	193	20697	194	20861	194	21012	236
19708	186	19774	186	20395	193	20698	194	20862	194	21015	236
19709	186	19775	186	20396	193	20724	204	20870	194	21018	236
19710	186	19776	186	20397	193	20725	204	20871	194	21023	236
19711	186	19776	186	20400	187	20726	204	20872	194	21110	236
19711	186	19777	186	20401	187	20727	204	20873	194	21111	236
19712	186	19778	186	20402	187	20728	204	20874	194	21112	236
19713	186	19779	186	20403	187	20729	204	20875	194	21115	236
19713	186	19780	186	20404	187	20730	204	20876	194	21118	236
19714	186	19781	186	20405	187	20731	204	20877	194	21123	236
19715	186	19781	186	20406	187	20732	204	20878	194	21130	236
19716	186	19782	186	20407	187	20733	204	20879	194	21135	236
19717	186	19783	186	20408	187	20734	204	20880	194	21140	236
19718	186	19783	186	20409	187	20735	204	20881	194	21150	236
19718	186	19784	186	20410	187	20736	204	20890	195	21180	236
19719	186	19785	186	20411	187	20737	204	20891	195	21190	236
19720	186	19786	186	20412	187	20738	204	20895	195	21192	239
19721	186	19786	186	20413	187	20739	204	20896	204	21194	239
19722	186	19787	186	20414	187	20740	204	20897	204	21195	237
19723	186	19788	186	20415	187	20741	204	20898	204	21200	234
19723	186	19789	186	20416	187	20743	106	20899	204	21201	234
19724	186	19790	186	20417	187	20743	197	20901	205	21203	234
19725	186	19791	186	20418	187	20744	197	20905	204	21204	234
19726	186	19792	186	20419	187	20744	208	20910	204	21210	234
19727	186	19793	186	20420	187	20745	208	20911	204	21211	234
19728	186	19794	186	20421	187	20748	194	20912	204	21212	234
19728	186	19795	186	20422	187	20749	194	20913	204	21215	234
19729	186	19796	186	20423	187	20750	194	20915	204	21218	234
19730	186	19797	186	20424	187	20751	194	20916	204	21219	234
19731	186	19798	186	20425	187	20752	194	20917	204	21220	234
19732	186	19799	186	20426	187	20753	194	20918	204	21223	234
19733	186	19800	186	20427	187	20754	194	20919	204	21224	234
19733	186	19801	186	20428	187	20755	194	20920	204	21301	235
19734	186	19802	186	20429	187	20756	194	20921	204	21303	235
19735	186	19841	187	20430	187	20757	194	20922	204	21306	239
19736	186	19842	187	20450	205	20758	194	20923	204	21308	239
19737	186	19845	187	20460	205	20759	194	20924	204	21311	235
19738	186	19885	187	20487	191	20760	194	20936	196	21312	235
19738	186	19895	187	20488	191	20761	194	20937	197	21315	235
19739	186	20210	205	20489	191	20762	194	20938	197	21318	235
19740	186	20220	187	20490	191	20764	194	20939	197	21323	235
19741	186	20225	187	20491	191	20765	194	20940	197	21324	235
19742	186	20230	187	20492	191	20766	194	20941	197	21326	235

LIST OF ITEMS



number of item	page	number of item	page	number of item	page	number of item	page	number of item	page	number of item	page
21327	235	21803	240	22031	212	22113	218	22222	238	22535	184
21410	235	21804	240	22032	212	22115	218	22224	238	22540	184
21411	235	21810	216	22033	213	22116	218	22225	238	22542	184
21412	235	21811	216	22034	213	22117	218	22228	238	22545	184
21415	235	21812	216	22035	213	22120	219	22229	238	22548	184
21418	235	21813	216	22036	213	22121	219	22230	239	22550	184
21423	235	21814	216	22037	211	22122	219	22232	239	22555	184
21424	235	21831	216	22038	211	22123	219	22234	239	22560	184
21425	237	21832	216	22039	211	22124	219	22236	239	22565	184
21426	237	21834	216	22040	211	22125	219	22238	239	22568	184
21427	237	21850	218	22041	214	22126	219	22240	238	22570	184
21428	237	21851	218	22042	214	22129	219	22242	238	22575	184
21430	237	21852	218	22043	214	22130	219	22244	238	22580	184
21431	237	21853	218	22044	214	22132	219	22246	238	22585	184
21432	237	21854	218	22045	216	22133	219	22248	238	22590	184
21440	204	21855	218	22046	216	22134	219	22251	238	22595	184
21441	204	21856	218	22047	216	22135	381	22252	238	22600	184
21442	204	21857	218	22048	216	22136	381	22253	238	22602	184
21443	204	21858	218	22049	216	22137	381	22254	238	22605	184
21444	204	21859	218	22050	216	22138	381	22255	238	22610	184
21445	204	21860	218	22051	216	22140	241	22258	238	22615	184
21446	204	21861	218	22052	216	22141	241	22259	238	22620	184
21450	205	21862	218	22053	216	22142	241	22260	238	22625	184
21451	205	21863	218	22054	216	22143	241	22263	238	22630	184
21452	205	21864	218	22055	216	22145	241	22264	238	22701	214
21453	206	21900	210	22056	216	22146	241	22266	238	22702	214
21454	206	21901	210	22057	216	22147	241	22269	238	22703	214
21530	205	21902	210	22058	212	22148	241	22270	238	22704	214
21540	206	21903	210	22059	212	22150	241	22273	238	22705	214
21541	206	21904	210	22060	214	22151	241	22274	238	22706	214
21701	217	21905	210	22061	214	22155	241	22275	238	22707	214
21702	217	21906	210	22062	214	22156	241	22277	238	23000	400
21703	217	21907	211	22063	214	22158	213	22280	238	23001	400
21704	217	21908	211	22064	214	22159	213	22281	238	23005	402
21705	217	21909	211	22065	215	22160	216	22285	239	23006	402
21706	217	21910	211	22066	215	22161	216	22286	239	23010	402
21709	217	21911	211	22067	217	22162	216	22294	239	23020	402
21715	217	21912	211	22068	215	22163	216	22300	222	23025	402
21716	217	21913	211	22069	215	22164	216	22301	222	23030	402
21717	217	21914	211	22070	215	22166	216	22302	222	23035	402
21718	217	21920	210	22071	215	22167	216	22303	222	23040	402
21719	217	21925	210	22072	215	22168	216	22305	222	23050	402
21720	217	21926	210	22073	214	22170	221	22307	222	23060	402
21721	217	21930	212	22074	214	22171	221	22309	222	23070	402
21724	217	21931	212	22075	217	22172	221	22310	222	23125	401
21732	217	21935	212	22076	217	22173	221	22311	222	23130	401
21734	217	21936	212	22077	217	22174	221	22312	222	23135	401
21735	217	21937	212	22078	213	22178	220	22313	222	23140	401
21736	217	21940	212	22079	213	22180	220	22314	222	23150	401
21737	217	21941	212	22080	213	22181	220	22315	222	23160	401
21740	217	22001	210	22081	213	22182	220	22317	222	23211	401
21741	217	22002	210	22082	213	22183	220	22318	222	23212	401
21742	217	22003	210	22083	215	22184	220	22319	222	23213	401
21743	217	22004	211	22084	215	22185	220	22320	222	23214	401
21744	217	22005	211	22085	215	22186	220	22322	222	23215	401
21750	217	22006	211	22086	213	22188	221	22324	222	23220	401
21751	217	22007	210	22087	214	22189	221	22326	222	23225	401
21752	217	22008	210	22088	215	22190	221	22328	222	23232	401
21753	217	22009	210	22090	215	22195	221	22329	222	23240	401
21754	217	22010	210	22091	215	22197	221	22332	222	23250	401
21780	241	22011	210	22092	215	22198	221	22333	222	23260	401
21781	241	22012	211	22093	215	22199	221	22335	222	23261	401
21782	241	22013	211	22095	215	22200	199	22337	222	23262	401
21783	241	22014	211	22096	216	22201	199	22340	222	23263	401
21784	241	22015	211	22097	216	22202	221	22343	222	23264	401
21786	241	22016	211	22098	216	22203	221	22345	222	23265	401
21787	241	22017	211	22099	216	22204	221	22350	222	23266	401
21788	241	22018	212	22100	218	22205	221	22351	222	23274	401
21789	241	22019	212	22101	218	22206	220	22355	222	23275	401
21790	241	22020	212	22102	218	22207	220	22357	222	23281	403
21792	241	22021	212	22103	218	22208	220	22365	222	23282	403
21793	241	22022	212	22104	218	22209	220	22370	222	23284	403
21794	241	22023	211	22105	218	22211	238	22398	222	23287	402
21795	241	22024	211	22106	218	22212	238	22399	222	23288	402
21796	241	22025	211	22107	218	22215	238	22510	184	23290	403
21798	215	22026	212	22108	218	22216	238	22515	184	23291	403
21798	241	22027	212	22109	218	22217	238	22520	184	23292	403
21800	240	22028	212	22110	218	22218	238	22525	184	23297	403
21801	240	22029	212	22111	218	22219	238	22530	184	23310	401
21802	240	22030	212	22112	218	22220	238	22532	184	23311	401

number of item	page	number of item	page	number of item	page	number of item	page	number of item	page	number of item	page
23312	401	23735	139	24001	137	24148	230	24483	192	24779	201
23390	403	23736	441	24002	137	24149	230	24650	200	24780	201
23391	403	23736	139	24005	137	24150	231	24655	201	24781	201
23400	133	23760	130	24006	137	24151	231	24658	201	24782	201
23401	133	23761	130	24007	136	24152	232	24670	200	24783	201
23402	133	23762	130	24010	136	24152	339	24671	200	24784	201
23406	133	23763	130	24015	137	24153	228	24672	200	24785	201
23407	133	23764	130	24017	137	24154	231	24673	200	24786	201
23410	133	23800	130	24020	137	24155	233	24674	200	24787	201
23411	133	23810	410	24030	137	24156	233	24675	200	24788	201
23412	133	23814	410	24035	138	24158	233	24676	200	24789	201
23415	133	23816	410	24036	138	24159	219	24690	209	24790	200
23416	133	23818	410	24038	138	24159	233	24691	209	24791	200
23417	133	23820	410	24039	138	24160	227	24695	209	24792	200
23420	133	23824	410	24040	138	24161	227	24700	200	24793	200
23506	132	23826	410	24041	138	24162	227	24701	200	24794	200
23507	132	23828	410	24042	138	24163	227	24702	200	24795	201
23508	132	23830	410	24043	138	24164	227	24703	200	24796	200
23515	132	23840	345	24045	224	24165	227	24704	200	24798	200
23520	132	23845	344	24050	226	24166	227	24705	200	25001	323
23525	132	23846	344	24055	223	24167	227	24706	207	25002	323
23530	132	23847	344	24055	282	24168	227	24712	207	25003	323
23531	132	23850	410	24060	223	24169	227	24713	208	25004	323
23551	132	23854	410	24061	223	24170	229	24714	208	25005	323
23560	131	23856	410	24062	223	24171	230	24715	208	25006	322
23561	131	23858	410	24063	223	24173	231	24716	208	25009	322
23562	131	23860	410	24064	223	24174	233	24717	198	25012	322
23563	131	23864	410	24065	223	24175	233	24718	198	25015	322
23564	131	23865	410	24066	223	24176	233	24719	198	25016	322
23565	131	23866	410	24067	223	24177	233	24720	208	25020	322
23566	131	23868	410	24068	223	24178	233	24721	208	25024	322
23570	131	23870	410	24069	223	24180	228	24722	208	25025	322
23571	131	23875	394	24070	223	24181	233	24723	198	25030	322
23572	131	23880	410	24071	223	24185	227	24725	198	25040	322
23573	131	23882	410	24072	223	24186	227	24726	198	25048	322
23574	131	23884	410	24073	223	24187	227	24727	295	25060	322
23585	132	23904	130	24074	223	24188	227	24728	295	25096	322
23587	132	23906	130	24075	223	24189	227	24729	295	25150	322
23589	132	23908	130	24076	223	24190	219	24730	197	25153	322
23591	132	23910	130	24077	223	24190	233	24731	197	25155	322
23600	132	23912	130	24078	223	24192	227	24732	197	25160	323
23601	132	23914	130	24080	224	24195	227	24735	199	25162	323
23602	132	23920	130	24081	224	24196	227	24736	199	25163	323
23605	132	23922	130	24082	224	24197	227	24737	199	25164	323
23620	132	23923	129	24083	224	24212	414	24738	199	25167	323
23625	132	23924	129	24084	224	24225	414	24739	199	25169	323
23626	132	23925	129	24085	224	24250	414	24740	199	25170	323
23628	132	23927	129	24086	224	24255	414	24741	199	25171	323
23630	132	23928	130	24087	224	24258	414	24743	199	25179	322
23632	132	23945	129	24098	224	24260	414	24745	198	25180	322
23650	134	23950	138	24099	224	24301	225	24746	199	25181	322
23655	134	23951	138	24100	228	24302	225	24747	198	25182	322
23657	135	23952	138	24102	228	24303	225	24748	199	25183	322
23657	278	23953	138	24104	228	24304	225	24749	199	25184	322
23660	134	23954	138	24108	227	24305	225	24750	192	25186	322
23670	131	23955	138	24109	228	24306	225	24751	192	25188	322
23671	131	23960	130	24110	229	24308	226	24752	295	25189	322
23672	131	23961	130	24111	229	24310	226	24753	295	25190	322
23673	131	23962	130	24118	228	24312	226	24755	206	25195	322
23674	131	23963	130	24119	228	24313	226	24756	206	25206	322
23675	131	23964	130	24120	227	24314	227	24757	198	25212	322
23676	131	23965	130	24121	229	24315	226	24758	198	25215	322
23677	131	23966	130	24122	229	24316	226	24759	198	25220	322
23678	131	23967	130	24124	229	24410	192	24760	200	25224	322
23679	131	23970	138	24125	229	24411	192	24761	200	25230	322
23680	131	23971	138	24126	229	24412	192	24762	200	25240	322
23681	131	23972	138	24128	231	24415	207	24763	200	25248	322
23682	131	23973	138	24130	230	24419	192	24764	200	25260	322
23683	131	23974	138	24131	230	24420	192	24765	200	25296	322
23684	131	23975	138	24133	230	24422	192	24766	200	25350	322
23685	131	23976	138	24135	231	24425	192	24767	200	25369	322
23730	441	23977	138	24136	231	24429	192	24768	200	25370	322
23730	139	23978	138	24137	231	24432	192	24769	200	25371	322
23731	441	23979	138	24140	231	24435	192	24770	199	25372	322
23731	139	23985	138	24141	231	24437	192	24771	199	25373	322
23732	441	23986	138	24142	231	24444	192	24772	199	25374	322
23732	139	23987	138	24143	230	24451	192	24773	199	25376	322
23734	441	23988	138	24144	230	24457	192	24774	199	25378	322
23734	139	23989	138	24145	230	24464	192	24776	200	25379	322
23735	441	24000	137	24147	230	24476	192	24778	201	25380	322

LIST OF ITEMS



number of item	page	number of item	page	number of item	page	number of item	page	number of item	page	number of item	page
25400	323	26963	440	31146	244	31559	249	32318	257	33257	430
25410	323	26972	441	31148	244	31601	255	32319	257	33258	430
26028	44	26973	441	31150	245	31602	255	32320	257	33270	431
26037	49	26974	441	31151	245	31603	255	32321	257	33275	431
26201	46	26975	441	31155	245	31610	249	32322	257	33275	431
26204	46	26976	441	31218	248	31641	255	32323	257	33280	431
26209	47	26977	441	31220	246	31651	255	32324	257	33285	431
26211	47	26979	443	31221	246	31655	255	32325	258	33286	431
26215	44	26985	442	31222	246	32001	252	32326	258	33289	431
26216	45	26986	442	31231	246	32002	252	32327	256	33291	431
26217	45	26988	443	31232	246	32003	252	32328	258	33292	431
26218	45	26996	443	31233	246	32013	252	32329	257	33293	431
26520	48	26997	443	31234	246	32014	252	32330	258	33298	431
26521	48	26998	443	31235	246	32015	252	32331	258	33299	431
26528	49	28000	4	31270	247	32016	252	32332	256	34005	259
26700	438	28001	5	31271	247	32018	252	32333	256	34006	259
26701	438	28002	5	31280	247	32020	252	32335	258	34007	259
26702	438	28003	6	31281	247	32021	252	32337	256	34027	259
26705	438	28004	6	31320	247	32022	255	32338	256	34028	258
26705	326	28005	7	31322	247	32023	255	32418	257	34033	264
26706	438	28006	7	31330	247	32024	252	32421	257	34041	259
26706	326	28007	8	31332	247	32026	252	33100	426	34051	259
26707	438	28008	8	31334	246	32037	255	33102	426	34053	259
26707	326	28021	9	31340	247	32040	255	33105	426	34061	260
26720	438	28025	9	31341	247	32041	255	33107	426	34071	260
26720	326	28030	12	31343	246	32042	255	33110	426	34081	260
26721	438	28032	12	31360	246	32043	255	33112	426	34091	260
26721	326	28035	14	31362	246	32044	255	33113	426	34101	260
26722	438	28040	13	31380	246	32050	255	33114	426	34111	260
26722	326	28045	13	31382	246	32051	255	33120	426	34115	260
26775	297	28050	15	31390	246	32052	255	33123	426	34116	260
26780	304	28055	15	31392	246	32053	255	33124	426	34117	260
26781	304	28065	11	31400	246	32060	252	33127	427	34118	260
26782	304	28070	10	31402	246	32062	252	33131	427	34121	260
26783	304	28080	18	31403	246	32064	252	33132	427	34122	260
26800	434	28081	18	31404	246	32066	252	33135	427	34132	260
26801	434	28085	18	31452	254	32076	252	33137	427	34142	260
26802	434	28086	18	31453	254	32161	251	33140	427	34152	260
26803	434	28101	16	31454	254	32162	251	33141	427	34153	260
26804	434	28102	17	31455	248	32163	251	33142	427	34154	260
26805	434	28103	17	31456	248	32164	251	33143	427	34155	260
26806	434	28104	16	31461	248	32165	251	33150	427	34156	260
26807	434	30003	259	31467	248	32166	251	33151	427	34157	260
26815	434	30003	264	31468	248	32167	251	33152	427	34158	260
26816	434	30004	259	31471	248	32168	251	33154	427	34159	260
26817	434	30004	264	31481	248	32169	251	33155	430	34160	260
26819	434	30005	259	31491	248	32170	248	33160	428	34200	260
26820	435	30005	264	31493	250	32171	251	33162	428	34201	260
26824	435	30007	259	31494	250	32172	251	33163	428	34202	260
26825	435	30007	264	31495	250	32173	248	33164	428	34203	260
26826	435	31005	245	31496	250	32174	251	33165	428	34221	264
26829	436	31006	245	31497	254	32176	251	33167	428	34223	264
26844	435	31007	245	31498	250	32176	251	33168	428	34231	265
26845	435	31008	245	31499	250	32186	251	33168	257	34235	265
26853	436	31009	245	31500	250	32206	251	33169	428	34237	265
26857	436	31011	245	31501	254	32216	251	33170	428	34238	265
26858	436	31021	245	31502	254	32226	251	33200	429	34241	264
26859	436	31031	245	31503	254	32234	251	33201	429	34243	264
26862	436	31041	245	31505	248	32240	251	33202	429	34251	264
26871	437	31051	245	31506	248	32265	253	33203	429	34261	265
26880	437	31052	246	31507	248	32268	253	33205	429	34262	264
26881	437	31053	245	31510	248	32269	253	33206	429	34265	265
26886	437	31061	246	31511	248	32270	253	33207	429	34271	260
26888	437	31062	246	31512	248	32273	253	33208	429	34272	260
26891	441	31071	246	31513	248	32283	253	33209	429	34273	260
26895	439	31072	246	31514	248	32285	253	33210	429	34274	260
26896	439	31081	246	31515	248	32293	253	33211	429	34275	260
26897	439	31082	245	31520	250	32295	253	33212	429	34276	260
26911	440	31091	244	31521	250	32296	253	33215	429	34280	260
26912	440	31101	244	31522	250	32297	253	33220	430	34281	260
26914	440	31111	244	31523	250	32298	253	33221	430	34282	260
26915	440	31121	244	31524	250	32301	253	33246	431	34283	260
26920	438	31131	244	31541	250	32302	253	33247	431	34284	260
26921	438	31132	244	31551	250	32311	257	33248	431	34285	260
26922	438	31140	244	31552	250	32312	256	33249	431	34300	297
26940	439	31141	244	31553	250	32313	253	33250	430	34301	260
26941	439	31142	244	31555	249	32314	257	33252	430	34303	297
26943	439	31143	244	31556	249	32315	258	33254	430	34304	260
26954	440	31144	244	31557	249	32316	258	33255	430	34305	254
26961	440	31145	244	31558	249	32317	256	33256	430	34306	254

LIST OF ITEMS

number of item	page	number of item	page	number of item	page	number of item	page	number of item	page	number of item	page
34307	254	35081	268	35517	273	37041	255	37204	286	37500	274
34308	254	35082	269	35518	273	37051	255	37205	286	37501	274
34315	219	35085	267	35519	273	37053	284	37205	286	37505	274
34316	172	35086	267	35524	273	37054	284	37210	285	37506	274
34316	219	35087	267	35525	273	37055	284	37211	285	37509	275
34400	262	35091	267	35527	273	37065	290	37212	286	37510	275
34401	262	35092	267	35532	273	37066	290	37216	298	37511	275
34402	263	35093	267	35533	273	37067	290	37217	298	37512	275
34403	263	35094	267	35539	273	37068	290	37218	298	37515	275
34404	262	35095	267	35540	273	37069	290	37218	298	37516	275
34405	262	35096	267	35542	273	37070	290	37220	285	37517	275
34406	263	35103	270	35552	273	37094	290	37229	299	37518	275
34407	263	35113	270	35553	273	37095	290	37230	299	37518	275
34409	262	35123	270	35555	273	37096	290	37231	299	37527	276
34410	262	35125	270	35555	273	37097	290	37232	299	37530	276
34411	263	35126	270	35603	276	37097	290	37233	299	37532	276
34412	263	35127	270	35604	276	37098	290	37234	299	37533	276
34413	263	35127	270	35605	276	37101	255	37234	299	37533	276
34414	264	35300	266	35605	276	37111	255	37235	299	37539	276
34415	262	35310	266	35833	271	37111	255	37236	298	37541	276
34416	262	35311	266	35845	271	37114	298	37237	298	37545	279
34417	263	35316	266	35850	271	37115	298	37238	298	37546	279
34418	263	35317	266	36014	282	37117	283	37238	298	37549	279
34418	263	35318	266	36024	282	37119	298	37239	298	37549	279
34419	262	35319	266	36034	282	37119	298	37243	321	37553	135
34420	262	35320	314	36035	282	37120	298	37244	321	37553	278
34421	263	35322	314	36036	282	37121	304	37245	321	37560	279
34422	263	35323	181	36046	282	37122	304	37246	321	37564	277
34423	263	35323	294	36056	283	37123	421	37247	321	37570	231
34424	263	35325	181	36057	283	37124	421	37248	321	37570	279
34425	262	35325	294	36058	283	37125	288	37250	321	37600	327
34426	262	35326	181	36058	283	37126	288	37251	321	37601	327
34428	263	35326	294	36059	283	37127	288	37252	321	37602	327
34429	264	35327	181	36076	281	37129	421	37253	321	37603	327
34439	262	35327	294	36077	281	37130	287	37255	308	37604	327
34440	262	35328	181	36080	281	37131	287	37256	308	37605	327
34441	262	35328	294	36081	281	37132	287	37257	308	37606	327
34442	262	35329	181	36082	281	37132	287	37258	308	37611	327
34443	262	35329	294	36085	281	37135	443	37259	308	37615	327
34445	262	35330	183	36086	281	37135	154	37263	308	37616	327
34446	262	35330	293	36088	281	37139	154	37264	308	37616	327
34447	262	35331	183	36087	281	37140	154	37264	308	37621	419
34448	263	35331	293	36126	282	37141	154	37266	308	37630	419
34449	262	35332	182	36128	282	37142	154	37267	308	37640	418
34450	262	35332	292	36130	282	37143	154	37268	308	37640	418
34451	262	35333	182	36136	282	37143	154	37268	308	37641	418
34452	263	35333	292	36140	285	37144	154	37270	308	37645	418
34453	262	35334	182	36145	280	37145	154	37271	308	37650	419
34454	262	35334	292	36145	280	37148	286	37272	308	37730	270
34455	263	35335	181	36160	280	37149	286	37273	308	37731	270
34456	263	35335	294	36175	280	37149	286	37275	308	37760	270
34457	263	35336	182	36190	280	37150	286	37275	308	37760	270
34458	263	35336	292	36191	280	37151	286	37280	309	37761	270
34459	264	35345	183	36199	281	37152	286	37281	309	38000	312
34479	264	35345	293	36200	281	37153	286	37290	321	38001	311
34480	262	35346	183	36240	281	37154	286	37291	321	38002	312
34481	262	35346	293	36300	279	37155	286	37295	410	38003	312
34482	262	35347	183	36305	413	37156	286	37295	309	38004	312
34485	262	35347	183	36306	413	37157	286	37296	410	38005	312
34486	262	35347	293	36308	297	37158	286	37296	410	38006	311
34490	263	35347	293	36310	277	37162	288	37297	410	38007	312
34491	263	35348	182	36312	297	37166	277	37297	309	38008	312
34496	263	35348	292	36313	413	37170	288	37297	309	38008	312
34500	264	35360	144	36314	413	37171	288	37300	158	38009	312
35006	268	35361	144	36325	289	37172	288	37301	158	38010	311
35007	268	35362	144	37005	317	37173	288	37302	158	38012	311
35011	270	35500	272	37006	284	37174	288	37303	158	38013	311
35012	268	35501	272	37006	284	37175	288	37308	159	38014	312
35013	268	35502	272	37007	284	37176	288	37309	159	38014	312
35015	269	35503	272	37007	284	37177	289	37310	157	38015	313
35021	269	35504	272	37008	284	37178	289	37311	157	38016	313
35023	267	35505	272	37009	284	37185	288	37317	337	38017	313
35038	267	35506	272	37010	431	37186	288	37320	157	38018	313
35048	269	35507	272	37011	284	37187	288	37321	157	38020	311
35058	267	35508	272	37012	284	37188	288	37325	156	38021	313
35059	268	35510	272	37021	284	37189	288	37326	156	38022	313
35068	269	35511	272	37025	283	37190	288	37328	156	38024	311
35069	268	35512	272	37026	283	37195	286	37330	155	38025	311
35070	269	35514	273	37026	283	37196	286	37331	155	38026	286
35078	268	35515	273	37028	283	37197	286	37332	155	38026	314
35079	269	35516	273	37028	283	37198	286	37332	155	38027	310
				37028	283	37199	287	37340	159	38028	310
				37028	283	37200	286	37342	158	38030	314
				37029	283	37201	286	37343	159	38031	313
				37029	283	37202	286	37344	159	38042	286
				37031	255	37202	286	37345	159	38042	314
						37203	286	37350	157	38050	305

LIST OF ITEMS



number of item	page	number of item	page	number of item	page	number of item	page	number of item	page	number of item	page
38052	305	38980	307	41120	387	42368	305	45019	336	45096	333
38054	305	38981	307	41121	387	42420	296	45020	332	45097	333
38055	305	38985	309	41122	387	43050	395	45021	336	45098	333
38060	305	38990	307	41123	387	43058	396	45023	332	45099	333
38063	305	38991	307	41150	387	43060	396	45025	336	45100	364
38065	305	38995	308	41151	387	43068	396	45026	335	45101	364
38095	305	39000	304	41152	387	43071	395	45027	336	45102	364
38096	305	39001	304	41153	387	43072	395	45029	336	45104	364
38097	305	39002	304	42101	387	43077	395	45030	232	45105	364
38895	291	39003	304	42102	387	43082	396	45030	339	45106	364
38896	291	39005	304	42103	387	43083	396	45031	232	45107	364
38899	291	39010	304	42115	299	43084	396	45031	339	45108	364
38900	291	39012	304	42120	299	43086	396	45032	232	45110	352
38901	291	39014	304	42150	389	43087	397	45032	339	45111	352
38902	291	39020	304	42151	389	43089	397	45033	232	45112	353
38903	291	39021	304	42152	389	43090	397	45033	339	45113	352
38904	291	39045	304	42153	389	43097	396	45034	342	45114	352
38905	291	39065	304	42155	389	43098	397	45035	341	45115	352
38906	291	39090	304	42156	389	43099	397	45036	345	45116	352
38907	291	39145	304	42157	389	43300	385	45038	342	45117	351
38908	291	39165	304	42158	389	43301	385	45039	342	45118	351
38909	291	39190	304	42160	389	44041	345	45040	342	45120	352
38910	291	39192	304	42161	389	44042	345	45041	342	45122	352
38911	291	39192	347	42162	389	44043	345	45042	347	45123	351
38912	291	39193	304	42163	389	44050	345	45043	344	45124	351
38913	291	39193	347	42170	389	44053	347	45044	345	45125	351
38914	291	39194	305	42171	389	44950	176	45045	177	45126	351
38915	291	39195	305	42172	389	44950	340	45045	344	45130	355
38916	291	39196	305	42173	389	44955	342	45046	177	45131	355
38917	291	39197	305	42174	389	44960	347	45046	344	45132	355
38918	291	39198	305	42175	389	44965	368	45047	347	45133	356
38919	285	39199	305	42176	389	44970	336	45048	177	45134	353
38920	285	39200	305	42177	389	44971	336	45048	335	45135	355
38923	285	39201	305	42178	389	44972	332	45048	344	45136	356
38924	307	39202	305	42179	389	44980	332	45049	345	45137	356
38925	307	39203	305	42180	389	44980	332	45050	368	45138	354
38926	309	39204	305	42181	389	44980	334	45051	369	45139	354
38927	307	39205	305	42182	389	44981	332	45052	369	45140	353
38928	308	39206	295	42185	389	44981	332	45053	370	45141	354
38929	307	39207	295	42186	389	44981	333	45054	370	45142	353
38930	309	39208	295	42187	389	44981	334	45055	369	45143	354
38931	307	39210	295	42188	389	44982	333	45056	341	45144	355
38932	307	39212	295	42190	306	44982	333	45057	341	45145	355
38933	309	39214	295	42190	389	44982	334	45058	341	45146	357
38934	308	39216	295	42201	390	44983	333	45059	341	45147	358
38935	309	39217	295	42202	390	44983	333	45060	232	45150	358
38937	309	39218	295	42203	390	44983	334	45060	339	45151	359
38939	309	39219	295	42207	390	44984	334	45061	232	45152	357
38940	309	39238	296	42208	390	44984	335	45061	339	45153	357
38941	309	39240	295	42209	390	44984	335	45062	232	45154	357
38942	308	39241	295	42210	390	44985	334	45062	339	45155	358
38943	309	39242	295	42211	390	44985	335	45063	332	45156	358
38944	306	39243	295	42212	390	44986	334	45065	341	45158	358
38945	306	39244	295	42213	390	44987	334	45066	341	45159	359
38946	306	39245	296	42214	390	44988	334	45067	341	45160	358
38947	306	40050	388	42217	390	44989	334	45068	177	45161	359
38948	306	40051	388	42218	390	44991	334	45068	335	45162	357
38949	306	40052	388	42219	390	44992	334	45068	344	45163	358
38950	296	40053	388	42220	390	44995	338	45069	176	45164	359
38951	296	40054	388	42221	390	44996	334	45069	340	45167	358
38952	296	40055	388	42228	390	44997	335	45070	370	45168	359
38953	296	40056	388	42229	390	44998	335	45071	369	45169	359
38954	296	40057	388	42230	390	44999	337	45074	346	45170	361
38955	306	40058	388	42240	390	45000	337	45079	342	45171	361
38956	306	40059	388	42244	390	45001	337	45080	342	45172	361
38957	306	40060	388	42248	390	45002	338	45081	176	45172	361
38958	306	40075	388	42249	390	45003	338	45081	340	45173	361
38959	306	40076	388	42251	390	45005	338	45082	176	45173	361
38960	306	40077	388	42252	390	45006	338	45082	340	45174	361
38961	306	40100	387	42253	390	45007	338	45083	176	45175	360
38963	309	40120	387	42255	390	45008	338	45083	340	45176	360
38964	307	41050	387	42256	390	45009	338	45084	176	45177	360
38965	308	41080	387	42257	390	45010	335	45084	340	45178	360
38966	307	41081	387	42260	391	45011	337	45085	347	45179	359
38968	307	41082	387	42261	391	45012	337	45086	346	45180	353
38969	309	41083	387	42312	296	45014	335	45088	333	45181	353
38970	296	41100	387	42312	390	45015	337	45089	333	45182	360
38971	296	41101	387	42365	305	45016	336	45093	347	45183	360
38972	309	41102	387	42366	305	45017	334	45094	334	45184	359
38973	309	41103	387	42367	305	45018	335	45095	333	45185	359

number of item	page	number of item	page	number of item	page	number of item	page	number of item	page	number of item	page
45186	359	45296	353	45520	343	45651	345	48415	328	50541	153
45187	360	45297	354	45521	343	45652	345	48420	328	50542	153
45190	362	45298	353	45522	343	45653	345	48452	328	50544	153
45191	362	45299	354	45523	343	45654	345	48453	328	50549	152
45192	362	45300	361	45524	343	45655	345	48454	328	50550	150
45193	362	45301	361	45525	343	45656	345	48455	328	50551	150
45194	362	45320	369	45526	343	45657	345	48456	328	50553	150
45195	362	45321	370	45527	343	45658	345	48457	328	50554	150
45196	362	45323	368	45528	343	45659	345	48719	279	50555	153
45197	362	45323	382	45529	343	45660	345	48729	277	50556	150
45198	362	45325	368	45530	343	45661	345	48730	277	50557	152
45199	362	45326	368	45531	343	45662	345	48731	277	50558	152
45200	362	45327	367	45532	343	45663	345	50004	414	50559	150
45203	363	45328	367	45533	343	45664	345	50005	414	50560	150
45204	363	45329	367	45534	343	45667	345	50009	415	50562	150
45206	362	45330	385	45535	346	45671	345	50010	415	50563	150
45211	363	45331	385	45540	346	45672	345	50011	415	50564	150
45213	355	45345	361	45541	346	45673	345	50012	415	50570	150
45214	357	45349	361	45542	346	48001	145	50013	415	50571	150
45215	356	45350	361	45543	346	48002	145	50014	415	50585	153
45216	357	45353	361	45550	346	48005	146	50015	415	50585	321
45217	357	45360	361	45551	346	48006	146	50017	417	50586	153
45218	356	45364	361	45552	346	48007	146	50019	417	50586	321
45219	356	45366	361	45553	346	48008	147	50020	417	50587	153
45220	363	45370	177	45555	346	48009	147	50021	417	50587	321
45221	363	45370	344	45556	346	48010	147	50022	417	50588	153
45222	363	45385	348	45557	346	48015	145	50025	417	50588	321
45223	363	45386	348	45558	346	48020	146	50026	417	50900	409
45224	363	45388	348	45559	346	48021	146	50030	391	50901	409
45225	363	45389	348	45560	345	48022	146	50031	391	50902	409
45226	363	45390	349	45562	346	48030	146	50032	391	50905	409
45227	363	45391	349	45563	346	48031	147	50033	391	50906	409
45228	363	45392	349	45564	346	48032	147	50035	443	50907	409
45229	363	45393	349	45565	346	48033	147	50035	391	50909	409
45239	366	45394	349	45570	389	48034	147	50036	443	50910	409
45240	366	45395	349	45571	389	48036	145	50036	391	50911	409
45241	366	45396	349	45572	389	48037	146	50037	391	50915	409
45242	366	45397	349	45573	389	48040	147	50038	391	50916	409
45244	365	45398	350	45580	390	48041	147	50040	391	50917	409
45245	365	45399	350	45600	363	48042	147	50041	391	50918	409
45246	365	45400	350	45601	363	48043	147	50042	391	50919	409
45247	365	45401	350	45602	363	48046	146	50050	305	50920	409
45248	365	45450	394	45603	363	48046	147	50050	305	51001	408
45249	365	45451	394	45604	363	48047	146	50051	305	51002	408
45250	365	45452	394	45605	363	48047	147	50052	305	51003	408
45251	365	45453	394	45606	363	48050	148	50052	305	51004	408
45253	365	45460	394	45607	363	48051	148	50100	324	51007	408
45254	365	45461	394	45608	363	48054	148	50101	324	51008	408
45256	365	45462	394	45609	363	48055	148	50102	324	51009	408
45257	365	45463	394	45610	363	48056	148	50103	324	51010	408
45260	365	45465	394	45611	363	48057	148	50104	324	51011	408
45261	365	45466	394	45612	363	48060	148	50106	324	51013	407
45262	365	45467	394	45613	363	48061	148	50108	324	51015	408
45262	366	45470	394	45614	363	48062	148	50500	151	51017	407
45263	365	45471	309	45615	363	48063	148	50501	151	51018	407
45263	366	45471	344	45616	363	48064	148	50502	151	51020	407
45265	366	45472	344	45617	363	48065	148	50503	151	51022	407
45266	366	45473	344	45618	363	48066	148	50505	151	51023	407
45267	365	45480	394	45619	363	48067	148	50510	149	51026	406
45267	366	45485	394	45620	363	48068	148	50511	149	51030	407
45268	365	45490	380	45621	363	48070	148	50512	149	51032	407
45268	366	45496	394	45622	363	48071	148	50513	149	51034	407
45269	366	45497	394	45623	363	48072	148	50514	149	51036	408
45270	365	45498	394	45624	363	48075	148	50518	151	51037	408
45271	365	45499	394	45625	363	48076	148	50519	151	51038	409
45272	365	45500	343	45626	363	48077	148	50520	151	51040	406
45273	365	45502	343	45627	363	48080	148	50521	151	51041	406
45274	365	45503	343	45628	363	48081	148	50522	152	51042	406
45280	364	45505	343	45629	363	48085	148	50523	151	51043	406
45283	364	45506	343	45630	363	48086	148	50524	151	51045	407
45285	364	45508	343	45631	363	48087	148	50525	152	51046	407
45286	364	45509	343	45632	363	48090	148	50526	152	51050	409
45287	364	45511	343	45633	363	48091	148	50527	153	51051	409
45289	355	45512	343	45634	363	48093	148	50529	152	51055	409
45290	355	45513	343	45635	363	48094	148	50531	152	51056	409
45291	355	45515	343	45636	363	48095	148	50532	153	51057	409
45292	356	45516	343	45637	363	48096	148	50533	152	51060	406
45293	356	45517	343	45638	363	48097	148	50537	152	51065	406
45294	354	45518	343	45639	363	48410	328	50539	152	51070	406
45295	354	45519	343	45650	345	48411	328	50540	153	51071	406

LIST OF ITEMS



number of item	page	number of item	page	number of item	page	number of item	page	number of item	page	number of item	page
51072	406	51288	325	52125	385	55041	143	55465	392	61077	380
51100	326	51300	324	52126	385	55050	143	55640	329	61079	380
51101	326	51301	324	52130	285	55051	143	55642	329	61085	342
51102	326	51302	324	52160	382	55060	143	55645	329	61088	374
51103	326	51303	324	52161	382	55080	143	60001	384	61089	373
51104	326	51304	324	52162	382	55100	143	60006	384	61090	374
51105	326	51305	324	52163	382	55120	143	60008	384	61097	376
51106	326	51306	324	52164	382	55140	143	60012	384	61098	376
51107	326	51307	324	52168	381	55160	143	60018	385	61111	378
51108	326	51308	324	52173	381	55180	143	60019	385	61112	378
51109	326	51320	324	52175	381	55181	143	60020	385	61114	378
51110	326	51321	324	52176	381	55200	143	60022	385	61120	378
51111	326	51322	324	52185	382	55201	143	60100	253	61121	378
51120	326	51323	324	52186	382	55220	143	60115	277	61130	369
51121	326	51324	324	52187	382	55221	143	60116	277	61131	369
51122	326	51325	324	52188	382	55240	143	60117	277	61132	369
51123	326	51327	324	52189	382	55300	143	60118	277	61133	369
51124	326	51338	326	52190	382	55301	143	60121	277	61134	370
51125	326	51341	326	52191	382	55311	143	60123	277	61135	370
51126	326	51348	326	52192	382	55313	143	60201	384	61136	367
51127	326	51402	325	52193	382	55314	143	60206	384	61137	367
51130	326	51403	325	52194	382	55315	143	60208	384	61138	367
51131	326	51404	325	52195	383	55316	143	60212	384	61139	368
51132	326	51405	325	52196	383	55317	143	61000	374	61140	368
51181	415	51406	325	52197	382	55318	143	61001	374	61141	370
51182	415	51407	325	52198	381	55319	143	61002	375	61142	370
51187	409	51408	325	52202	316	55331	143	61003	376	61143	371
51196	326	51410	325	52203	316	55332	143	61004	375	61144	371
51197	326	51412	325	52204	316	55333	143	61005	372	61145	371
51198	326	51413	325	52205	316	55334	143	61006	372	61146	371
51199	326	51414	325	52206	316	55335	143	61007	373	61147	367
51200	409	51415	325	52207	316	55336	143	61008	372	61148	367
51201	409	51416	325	52208	316	55337	143	61009	377	61149	368
51202	409	51417	325	52212	316	55339	143	61010	373	61149	382
51203	409	51418	325	52213	316	55340	143	61012	377	61150	369
51204	324	51420	325	52214	316	55341	143	61013	376	61155	372
51205	324	51430	325	52215	316	55342	143	61014	377	61156	372
51206	324	51431	325	52216	316	55350	143	61015	373	61157	372
51207	324	51432	325	52217	316	55351	143	61018	376	61158	372
51208	324	51433	325	52218	316	55352	143	61019	376	61161	375
51209	324	51435	325	52220	316	55353	143	61020	374	61162	376
51210	324	51436	325	52283	316	55354	143	61021	373	61163	376
51211	324	51450	325	52284	316	55355	143	61022	374	61164	377
51212	324	51510	403	52285	316	55356	143	61024	375	61165	377
51220	325	51511	403	52286	316	55357	143	61025	373	61166	377
51221	325	51512	403	52288	316	55358	143	61026	373	61169	253
51222	325	51513	403	52305	319	55359	143	61028	377	61171	385
51225	325	51514	403	52306	319	55360	143	61029	373	61172	382
51226	325	51515	403	52315	319	55361	143	61030	371	61172	385
51227	325	51516	403	52328	319	55362	143	61031	371	61173	385
51241	324	51517	403	52331	319	55400	392	61032	371	61174	385
51242	324	52010	416	52334	319	55401	392	61033	371	61175	385
51243	324	52011	249	52391	319	55402	392	61034	371	61176	385
51244	324	52011	320	52421	319	55403	392	61035	378	61177	385
51245	324	52012	416	52424	319	55404	392	61036	378	61183	386
51246	324	52020	416	52428	319	55405	392	61038	378	61184	386
51247	324	52030	416	52456	319	55406	392	61040	378	61189	386
51257	326	52030	260	52471	319	55420	392	61042	378	61190	386
51258	326	52050	328	52600	318	55421	392	61044	377	61192	385
51259	326	52055	328	52601	318	55422	392	61045	371	61193	385
51260	326	52060	328	52602	318	55423	392	61046	371	61194	385
51261	326	52065	328	52605	318	55424	392	61047	371	61195	386
51262	326	52070	316	52610	318	55425	392	61048	371	61200	385
51263	326	52071	317	52611	297	55429	392	61050	374	61201	385
51264	326	52075	317	52612	297	55430	392	61051	374	61201	385
51265	326	52076	317	52620	321	55431	392	61052	375	61202	386
51271	324	52077	317	52625	321	55432	392	61053	374	61203	377
51272	324	52078	317	52630	321	55433	392	61054	375	61204	386
51273	324	52101	382	52635	321	55436	392	61056	373	61205	386
51274	324	52102	382	52640	321	55437	392	61057	373	61207	386
51275	324	52103	382	52645	321	55450	393	61058	375	61208	386
51276	324	52104	382	52652	321	55452	393	61059	375	61209	377
51278	324	52105	382	52656	321	55453	393	61060	371	61215	386
51280	325	52108	382	52662	320	55454	393	61061	371	61218	253
51281	325	52109	383	52666	320	55455	393	61062	371	61219	386
51282	325	52113	383	52671	320	55456	393	61063	371	61221	379
51283	325	52114	383	52694	320	55457	393	61067	379	61221	379
51284	325	52115	383	52695	320	55460	393	61068	379	61221	379
51286	325	52116	383	54008	321	55461	393	61069	379	61221	379
51287	325	52119	381	55040	143	55462	393	61070	379	61222	377

number of item	page	number of item	page	number of item	page	number of item	page	number of item	page	number of item	page
61223	376	70036	140	81152	424	81267	423	81348	423	81430	423
61224	378	70037	140	81155	424	81268	423	81349	423	81431	423
61224	378	70038	140	81160	425	81269	423	81350	423	81432	423
61230	386	70040	140	81165	425	81270	423	81351	423	81433	423
61235	416	70045	140	81170	424	81271	423	81352	423	81434	423
61240	118	70046	140	81175	425	81272	423	81353	423	81435	423
61250	386	70060	141	81178	425	81273	423	81354	423	81436	423
61251	347	70061	141	81180	425	81274	423	81355	423	81437	423
61251	386	70062	141	81185	424	81275	423	81356	423	81438	423
61252	386	70063	141	81186	424	81276	423	81357	423	81439	423
61253	386	70064	141	81189	424	81277	423	81358	423	81440	423
61254	386	70065	142	81190	425	81278	423	81359	423	81441	423
61255	386	70066	141	81191	425	81279	423	81360	423	81442	423
61256	386	70070	142	81200	423	81280	423	81361	423	81443	423
61290	379	70075	142	81201	423	81281	423	81362	423	81444	423
61291	379	70090	142	81202	423	81282	423	81363	423	81445	423
61292	379	70091	142	81203	423	81284	423	81364	423	81447	423
61293	379	70092	142	81204	423	81285	423	81365	423	81448	423
61294	379	70093	142	81205	423	81286	423	81366	423	81449	423
61295	379	70094	142	81206	423	81287	423	81367	423	81450	423
61296	379	70095	142	81207	423	81288	423	81370	423	81451	423
61297	379	70096	142	81208	423	81289	423	81371	423	81452	423
61299	393	70098	92	81209	423	81290	423	81372	423	81453	423
61300	393	70100	405	81210	423	81291	423	81373	423	81454	423
61301	393	70101	405	81211	423	81292	423	81374	423	81455	423
61302	393	70102	405	81212	423	81293	423	81375	423	81456	423
61320	119	70103	405	81213	423	81294	423	81376	423	81457	423
61321	119	70104	405	81214	423	81295	423	81377	423	81458	423
61322	119	70105	405	81215	423	81296	423	81378	423	81459	423
61323	119	70106	405	81216	423	81297	423	81379	423	81460	423
61324	119	70107	405	81217	423	81298	423	81380	423	81461	423
61325	119	70108	405	81218	423	81299	423	81381	423	81462	423
61326	119	70109	405	81219	423	81300	423	81382	423	81463	423
61327	119	70110	405	81220	423	81301	423	81383	423	81466	423
61328	119	70120	404	81221	423	81302	423	81384	423	81467	423
61329	119	70121	404	81222	423	81303	423	81385	423	81468	423
61330	119	70122	404	81223	423	81304	423	81386	423	81469	423
61331	119	70123	404	81224	423	81305	423	81387	423	81470	423
61340	123	70124	404	81225	423	81306	423	81388	423	81471	423
61341	123	70125	404	81226	423	81307	423	81389	423	81472	423
61342	123	70140	404	81227	423	81308	423	81390	423	81473	423
61343	123	70141	404	81228	423	81309	423	81391	423	81486	423
61344	123	70220	414	81229	423	81310	423	81392	423	81600	421
61345	123	70221	414	81230	423	81311	423	81393	423	81603	421
61346	123	81011	422	81231	423	81312	423	81394	423	82105	299
65062	329	81011A	422	81232	423	81313	423	81395	423	89970	411
65063	329	81011F	422	81233	423	81314	423	81396	423	89970	315
65064	329	81011G	422	81234	423	81315	423	81397	423	89973	411
65065	329	81011H	422	81235	423	81316	423	81398	423	89973	315
69900	301	81011R	422	81236	423	81317	423	81399	423	89975	411
69901	301	81012	422	81237	423	81318	423	81400	423	89975	315
69902	301	81013	422	81238	423	81319	423	81401	423	89980	411
69903	301	81014	422	81239	423	81320	423	81402	423	89980	315
69904	300	81015	422	81240	423	81321	423	81403	423	89985	411
69905	301	81016	422	81241	423	81322	423	81404	423	89985	315
69906	301	81022	422	81242	423	81323	423	81405	423	89987	411
69907	303	81023	422	81243	423	81324	423	81406	423	89987	315
69908	303	81024	422	81244	423	81325	423	81407	423	89988	411
69909	303	81025	422	81245	423	81326	423	81408	423	89988	315
69910	302	81035	422	81246	423	81327	423	81409	423	89989	411
69911	302	81036	422	81247	423	81328	423	81410	423	89989	315
69912	302	81053	420	81248	423	81329	423	81411	423	89990	411
69914	301	81054	420	81249	423	81330	423	81412	423	89990	315
69917	302	81056	420	81250	423	81331	423	81413	423	90070	283
69918	300	81057	420	81251	423	81332	423	81414	423	90071	283
69919	300	81070	420	81252	423	81333	423	81415	423	90072	283
69920	303	81071	420	81253	423	81334	423	81416	423	90191	185
69923	303	81072	420	81254	423	81335	423	81417	423	90192	186
69928	303	81074	420	81255	423	81336	423	81418	423		
69930	302	81075	420	81256	423	81337	423	81419	423		
69931	302	81077	420	81257	423	81338	423	81420	423		
70020	140	81100	420	81258	423	81339	423	81421	423		
70021	140	81101	420	81259	423	81340	423	81422	423		
70025	140	81102	420	81260	423	81341	423	81423	423		
70026	140	81103	420	81261	423	81342	423	81424	423		
70030	140	81104	420	81262	423	81343	423	81425	423		
70031	140	81105	420	81263	423	81344	423	81426	423		
70032	140	81106	420	81264	423	81345	423	81427	423		
70033	140	81150	424	81265	423	81346	423	81428	423		
70035	140	81151	424	81266	423	81347	423	81429	423		

GRAPHIC SYMBOLS USED IN CATALOG

PRODUCT SPECIFICATIONS USED ICONS



- S2** · functional parts made of high-alloy tool steels S2
- HSS** · functional parts made of high-speed steel
- Cr-Mo** · functional parts from chrome-molybdenum steel
- CrV** · functional parts from chrome-vanadium steel
- INOX** · functional parts from stainless steel
- NYLON** · nylon handle
- TEFLON** · teflon surface
- Zn** · zinc coated surface
- TiN** · titanium nitride coated surface
- HRC 58-61** · the hardness of the functional parts material (Rockwell)
- 40% PES** · material composition - contains 40% of polyester
- PES** · material composition - made of polyester
- DIAMOND** · diamond grains on the surface of functional parts
- MAGNETIC** · magnetic

- SDS+** **SDS MAX** **M14** · mounting type
- 72T** **36T** · number of ratchet teeth
- 1/2"** **3/4"** **1/4"** · mounting size
- 27 dB** · information about hearing protection
- DIN 3113** **IP 54** · complies with this standard
- 32x** · set contains this number of products
- II. class** **III. class** · complies with the specified accuracy class
- COLD WEATHER** · suitable for cold weather
- ERGO HANDLE** · ergonomic handle
- HOBBY** · for hobby use
- 2x AAA** · number and type of batteries
- UV STABLE** · UV stable
- RUBBER ENDS** · crashproof rubber ends

APPLICATION SPECIFICATIONS

- wood ·
- ceramics ·
- plastic ·
- aluminium · **ALU**
- copper · **Cu**
- stone ·
- glass ·
- masonry ·
- paper ·
- steel ·
- composite ·
- tiles ·
- stainless steel · **INOX**
- plaster ·
- wood with screw, nails ·
- drywall ·
- for drilling in materials with tensile strength up to ... **900 MPa**



PACKAGING INFORMATION

- packed in a box
- packed with euroslot
- MOQ 12** · minimum order quantity
- 5** · no. of pieces in the package

WATERING PRODUCTS SPECIFICATIONS

- adjustable spray patterns ·
- minimum and maximum pressure · **2bar min** **4bar max**
- maximum water flow · **Max 27L/min**
- irrigated area · **318 m²**
- adaptor thread size · **1/2"**
- hose diameter for connector · **1/2"**



20

23

24



PROFESSIONAL X TOOLS



festatools



#festatools



festatools

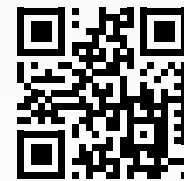

www.festa.tools

HORIZONT.



ROSA KOMELON.

KDS

Stahlberg

SUPER PRO

Lescha

