

FESTA[®]

PROFESIONÁLNÍ X NÁŘADÍ



NOVINKY
2024

otáčky
0 - 850 min⁻¹

BPM / příklep
0 - 4500 / 6 J

výkon
1500 W

upínání
SDS+



MAX Ø
beton - ø 32 mm
kov - ø 13 mm
dřevo - ø 40 mm



hloubkový doraz

systém pro omezení vibrací

ergonomická
pogumovaná
rukojeť pro
pohodlný a
bezpečný úchop

SDS+ upínací
hlava nástroje

přídavná rukojeť



2.0m

FESTA
POWER X TOOLS

SEKACÍ A VRTACÍ KLADIVO

Sada obsahuje:

- sekací kladivo
- přídavnou rukojeť
- hloubkový doraz
- montážní klíč
- kufr
- náhradní uhlíky
- nástroje SDS+:

Ø 8, 10, 12 x 160 mm

20 x 250 mm

14 x 250 mm



230 V ~ 50Hz	1500 W	0-4500 bpm	0-850 min ⁻¹	6 J	SDS+	2 m RUBBER	5.0 KG
-----------------	--------	------------	-------------------------	-----	------	------------	--------

náhradní uhlíky 2 ks - 28228



Č.p. Specifikace

28225

otáčky
0 - 1350 min⁻¹

BPM / přiklep
0 - 5500 / 2,8 J

výkon
800 W

upínání
SDS+
ø 2 - 13 mm



MAX ø beton - ø 26 mm
kov - ø 13 mm
dřevo - ø 30 mm



SDS+

ø 2 - 13 mm

FESTA
POWER X TOOLS

VRTACÍ A SEKACÍ KLADIVO

Sada obsahuje:

- vrtací kladivo
- přídavnou rukojeť
- hloubkový doraz
- sklíčidlo ø 2 - 13 mm
- kufr
- vazelína
- náhradní uhlíky
- nástroje SDS+:

ø 6, 8, 10 x 160 mm

20 x 250 mm

14 x 250 mm



náhradní uhlíky 2 ks - 28223



č.p. Specifikace
28220



otáčky
0 - 4500 min⁻¹

hmotnost
4,3 kg

výkon
1400 W

kotouč / upínání
max ø 185 mm / ø 20 mm



max. 63 mm



ergonomická
pogumovaná
rukojeť pro
pohodlný a
bezpečný úchop



boční vedení
- doraz 6 - 120 mm



odsávání prachu
ø 35 mm

2.0m

FESTA
POWER X TOOLS

KOTOUČOVÁ PILA

- Sada obsahuje:
- kotoučovou pilu
 - doraz bočního vedení
 - montážní inbus
 - náhradní uhlíky
 - kotouč ø 185 x 2,3/1,3 x 20 mm 24T (22316)



1400W	230V ~ 50Hz	4500 min ⁻¹	ø 20 185 mm	90°	45°	42 mm	4.3
-------	----------------	------------------------	----------------	-----	-----	-------	-----

náhradní
uhlíky 2 ks - 28233



Č.p. Specifikace

28230

4

otáčky
11000 min⁻¹

hmotnost
2 kg

výkon
900 W

upínání
M14
max ø 125 mm

přídavná rukojeť

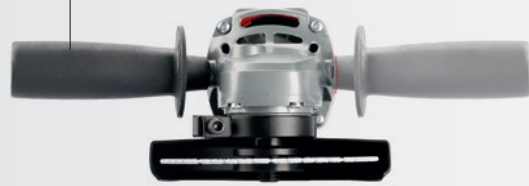

spínač s pojistkou

SOFT START
plynulý rozběh motoru



kryt kotouče



FESTA
POWER X TOOLS

ÚHLOVÁ BRUSKA

Sada obsahuje:

- úhlovou brusku
- kryt kotouče
- přídavnou rukojeť
- montážní klíč
- náhradní uhlíky



náhradní uhlíky 2 ks - 28213



Č.p. Specifikace
28210

otáčky
6600 min⁻¹

hmotnost
5,8 kg

výkon
2400 W

upínání
M14
max ø 230 mm



ergonomická
pogumovaná
rukojeť pro
pohodlný a
bezpečný úchop

SOFT START

plynulý rozběh motoru

bezpečnostní pádlový spínač

2.0m

kryt kotouče



FESTA
POWER X TOOLS

ÚHLOVÁ BRUSKA

- Sada obsahuje:
- úhlovou brusku
 - kryt kotouče
 - přídavnou rukojeť
 - montážní klíč
 - náhradní uhlíky



náhradní
uhlíky 2 ks - 28218



Č.p. Specifikace

28215

2

max. tlak
8,2 bar

manometr
psi, bar,
kgf/cm², kPa

hadice
Ø 10,5 x 600 mm

napětí
20 V

podsvícený display
manometru



ergonomická
pogumovaná
rukojeť pro
pohodlný a
bezpečný úchop

rychloupínací
spona na huštění
pneumatik

napájecí adaptér
do autozásuvky 3 m

hadice
Ø 10,5 x 600 mm



adaptéry

LED osvětlení



FESTA
POWER X TOOLS

**KOMPRESOR AKU
SHARE
20V**

baterie*



2 Ah - 28080



4 Ah - 28081



8 Ah - 28083



Sada obsahuje:

- kompresor
- adaptér do autozásuvky
- 3x adaptéry pro nafukování

*baterie není součástí balení

Č. p. Specifikace

28075

02/2024



max. nosnost
60 kg

vibrace
12 stupňů,
3500 - 8500 r/min

hmotnost
3 kg

napětí
20 V

svítící display



ergonomická
pogumovaná
rukojeť pro
pohodlný a
bezpečný úchop



přířavka Ø 125 mm



FESTA
POWER X TOOLS

VIBRÁTOR
S PŘÍSAVKOU NA DLAŽBU AKU
SHARE
20V

baterie*

FESTA
POWER X TOOLS
Li-ion
technology

2 Ah - 28080



4 Ah - 28081



8 Ah - 28083



Sada obsahuje:

- vibrační přířavku
- baterii 2,0 Ah (pouze 36328)
- nabíječku (pouze 36328)
- kufr

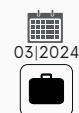

03/2024

Č.p.	Specifikace	
36328	s baterií 2Ah a nabíječkou	1
36329	bez baterie a nabíječky	1

příjem
DAB+ / FM / BT

výkon
2x 15 W

voděodolnost
IPX54

napětí
20 V



USB pro nabíjení



SHARE
napájení **20V**



FM anténa

barevný display



vstup jack 3,5 mm

stereo reproduktory



napájení - adaptér 230V



FESTA
POWER X TOOLS

RÁDIO AKU DAB+ / FM / BT

- stereo
- příjem DAB+ / FM
- externí vstup Bluetooth V5.0 / AUX IN 3,5 mm jack
- voděodolnost IPX54
- 30 paměťových míst (30 pro DAB / 30 pro FM)
- USB pro nabíjení
- barevný display 2,4"
- výkon 2x 15 W
- 20 V / 1,3 A
- napájecí adaptér

SHARE
20V

battery*

FESTA
POWER X TOOLS
Li-ion
technology

2 Ah - 28080



4 Ah - 28081



8 Ah - 28083



*baterie není součástí balení

02/2024



rychlost
vytlačování
0-8,5 mm/s

hmotnost
2 kg

napětí
20 V

vytlačovací
síla
6000 N

velikost kartuše 310 ml



ergonomická
pogumovaná
rukojeť pro
pohodlný a
bezpečný úchop

plynulá regulace
rychlosti vytlačování



LED osvětlení

FESTA
POWER X TOOLS

**PISTOLE VYTLAČOVACÍ AKU
SHARE
20V**

2 Ah - 28080



4 Ah - 28081



8 Ah - 28083



battery*

FESTA
POWER X TOOLS
Li-ion
technology



*baterie není součástí balení



Č.p. Specifikace

28060

1

indikátor
nabití
baterie



FESTA
POWER X TOOLS

**BATERIE 20 V I 8,0 Ah
SHARE
20V**

Li-ion
technology

20V **8,0 Ah** **Li-ion** **1,0**

02|2024



Č.p. Specifikace

28083

1



FESTA

**KOTOUČ PILOVÝ DO DŘEVA
S SK PLÁTKY**

pro 28230

FESTA
POWER X TOOLS



Č.p. Specifikace

22316 Ø 185 mm x 2,3 mm / 1,3 x Ø 20 mm 24T

1

FESTA

SADA NÁSTROJŮ PRO OSCILAČNÍ BRUSKU

pro 28045

FESTA
POWER X TOOLS



4x

3x BI-METAL



1x SK5



Č.p. Specifikace

24322

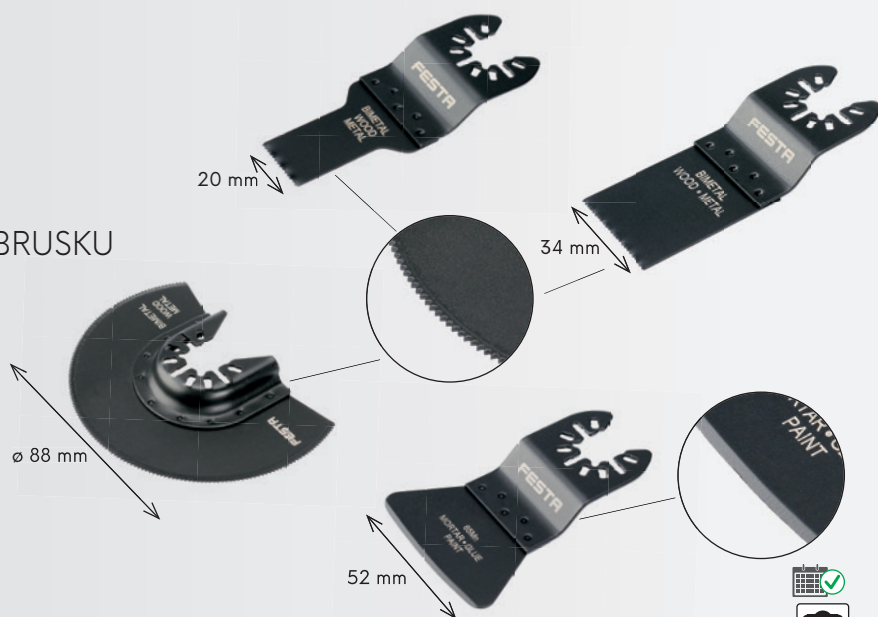

6

FESTA

SADA NÁSTROJŮ PRO OSCILAČNÍ BRUSKU

pro 28045

FESTA
POWER X TOOLS



4x

3x CARBIDE



1x



Č.p. Specifikace

24321

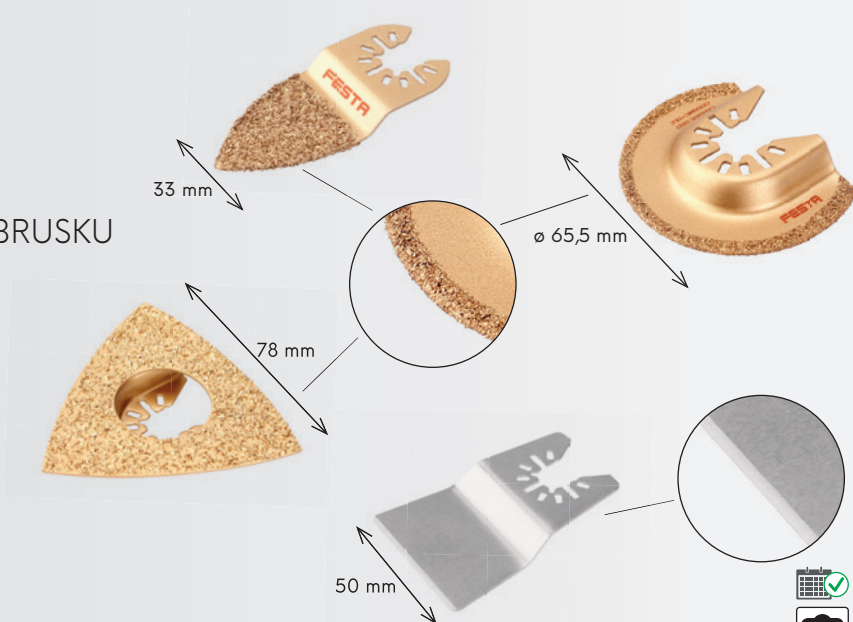

6

SADA NÁSTROJŮ PRO OSCILAČNÍ BRUSKU

pro 28045

FESTA
POWER X TOOLS



3x



Č.p. Specifikace

24320

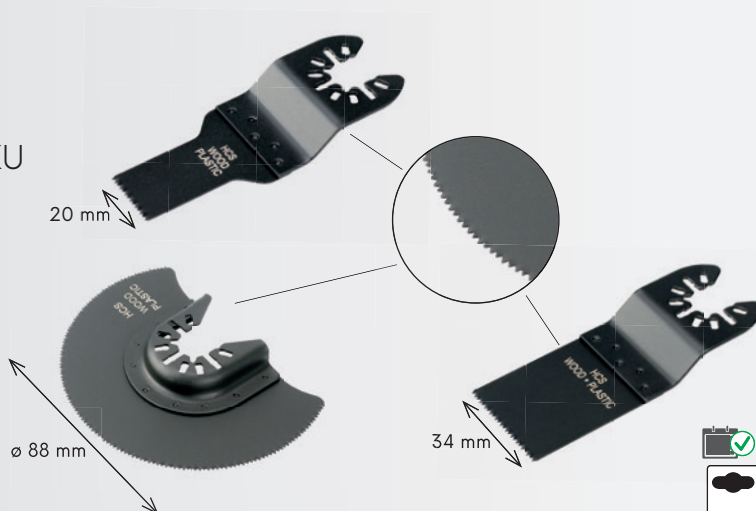

6



FESTA

ZKOUŠEČKA NAPĚTÍ

- AC / DC - 6 V, 12 V, 24 V, 50 V, 120 V, 230 V, 400 V
- odolnost proti vniknutí vody IP54
- určení polarity
- CAT III 400 V



Č.p. Specifikace

18428



02/2024



1

FESTA

MULTIMETR

- měření napětí DC: 200 mV - 300 V
- měření napětí AC: 200 mV - 300 V
- měření proudu DC: 2000 μ A - 10 A
- měření odporu: 200 Ω - 2 M Ω
- kontrola baterií: 1,5 V, 9 V
- indikace slabé baterie
- ochrana proti přetížení

- IEC61010
- CATIII 300 V
- certifikát GS
- napájení: 9 V baterie (6F22)
- rozměry: 70x128x28 mm
- hmotnost: 137 g (s baterií)
- příslušenství: testovací kabely



Č.p. Specifikace

18429



03/2024



1



FESTA

KLEŠTĚ ODIZOLOVÁVACÍ

- 0,5 - 6 mm²
- délka 190 mm

Č.p. Specifikace

17178



02/2024



1



FESTA

ÚHELNÍK MULTIFUNKČNÍ 3D



Č.p. Specifikace

14418



10



HORIZONT

STAHOVACÍ LAŤ - NASTAVITELNÁ

Č.p. Specifikace

15893	65 - 100 cm
15894	95 - 150 cm
15895	145 - 235 cm



1

1

1



FESTA

ZNAČKOVACĚ HLOUBKOVÝ, PERMANENTNÍ



Č.p. Specifikace

13247	● červený	46
13248	○ bílý	46

02|2024



FESTA

KLEŠTĚ SIKO

CrV

Č.p. Specifikace

16500	180 mm	0 - 35 mm	1
16501	250 mm	0 - 45 mm	1
16502	300 mm	0 - 60 mm	1



1

1

1

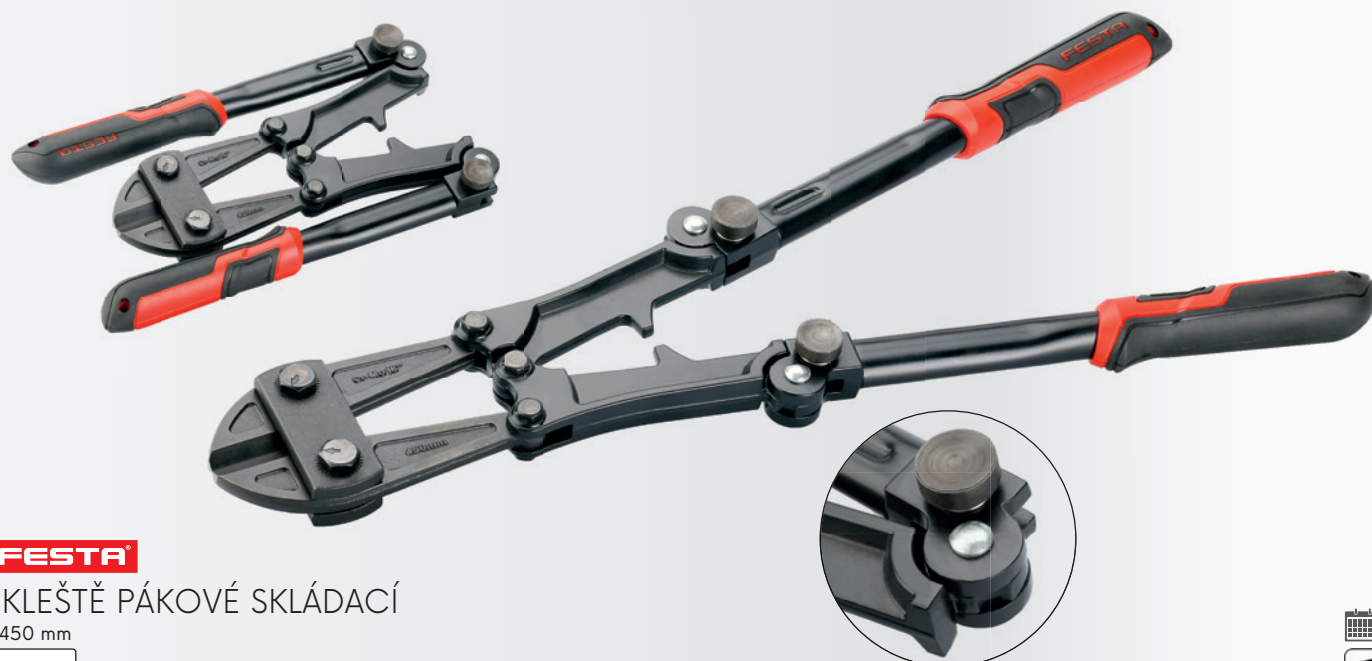
**FESTA**

KLEŠTĚ PÁKOVÉ SKLÁDACÍ

450 mm

Cr-Mo

Č.p. Specifikace

17049



1



26730

26731

FESTA

OHÝBAČKA TYČÍ, TRŽMENŮ, DRÁTŮ

Č.p. Specifikace

26730 Ø 6 - 14 mm

26731 Ø 5 - 8 mm



1

1



OHÝBAČKA TYČÍ

Č.p. Specifikace

26735 max Ø 13 mm

56 cm

02|2024



1



KLEŠTĚ RYCHLOUPÍNACÍ

Č.p. 17150
Specifikace 220 mm

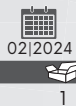

KLEŠTĚ RYCHLOUPÍNACÍ

Č.p. 17151
Specifikace 220 mm



FESTA

NŮŽKY NA PLECH
PRODLOUŽENÉ



Cr-Mo HRC 58-62

Č.p. 17113
Specifikace rovné 80 | 300 mm

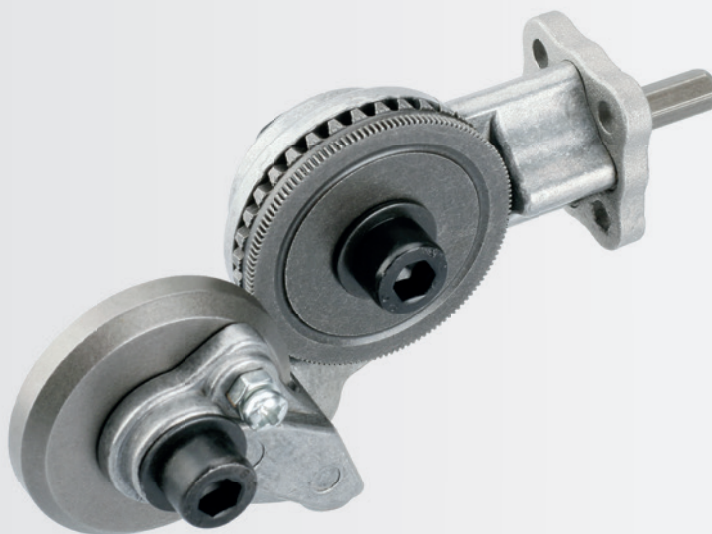
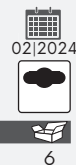
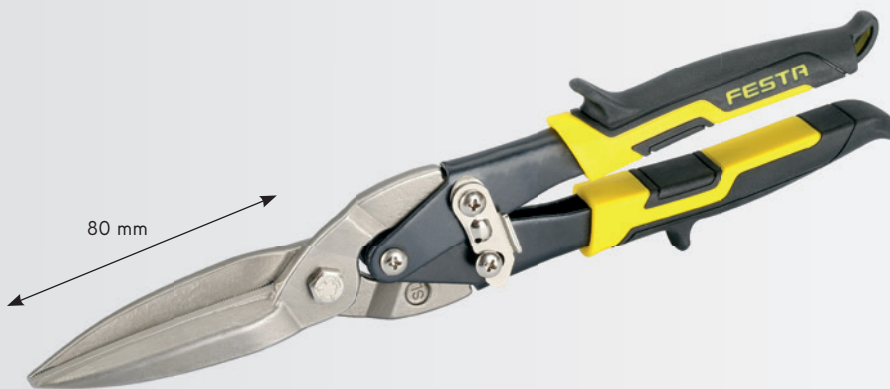

FESTA

NÁSTAVEC NA STRÍHÁNÍ PLECHU



Č.p. 20364
Specifikace





FESTA

ŘEZAČ TRUBEK

INOX ALU

ALU Cu PVC

Č.p.	Specifikace	
16305	Ø 22 mm	10
16306	Ø 15 mm	10



FESTA
INDUSTRY

BIT TORZNÍ PH - 50 MM



S2

2x



Č.p.	specifikace	
18715	PH1 x 50 mm	1
18716	PH2 x 50 mm	1
18717	PH3 x 50 mm	1



FESTA
INDUSTRY

BIT TORZNÍ PZ - 50 MM



S2

2x



Č.p.	specifikace	
18710	PZ1 x 50 mm	1
18711	PZ2 x 50 mm	1
18712	PZ3 x 50 mm	1



FESTA
INDUSTRY

BIT TORZNÍ T - 50 MM



S2

2x



Č.p.	specifikace	
18720	T10 x 50 mm	1
18721	T15 x 50 mm	1
18722	T20 x 50 mm	1
18723	T25 x 50 mm	1
18724	T30 x 50 mm	1
18725	T40 x 50 mm	1

FESTA

SADA BITŮ

bity 25 mm

- ⊖ S 3 · 4 · 5 · 6
- ⊕ PH 0 · 1 · 2 · 3
- ⊛ PZ 0 · 1 · 2 · 3
- ⊙ H 3 · 4 · 5 · 6
- ⊛ T 10 · 15 · 20 · 25 · 27 · 30 · 40
- ⊛ TTa 10 · 15 · 20 · 25 · 27 · 30 · 40

nástavec na bity ○

32x

CrV



Č.p.	Specifikace	
18908		1





FESTA

NÁSTAVEC NÝTOVACÍ NA VRTAČKU

- Ø 2,4 mm
- Ø 3,2 mm
- Ø 4,0 mm
- Ø 4,8 mm



Cr-Mo

Č.p. Specifikace
24008



FESTA

PISTOLE FOUKACÍ S DIGITÁLNÍM MANOMETREM

- 0 - 10 bar
- LCD display
- bar, kPa, Psi, kgf/cm²



Č.p. Specifikace
48011 0 - 10 bar



FESTA

PISTOLE OFUKOVACÍ S NÁSTAVCI

- 25 mm
- 90 mm
- 190 mm

Č.p. Specifikace
48004



**FESTA**

SVĚRKA ROHOVÁ 90°



4x

03|2024



Č.p. Specifikace
23607 upínací síla - 250 N



1

**FESTA**KOZA SKLÁDACÍ
· maximální nosnost: 400 kg

Č.p. Specifikace

23658

04|2024



1



RUKAVICE NYLON
MÁČENÉ V LATEXOVÉ PĚNĚ

02/2024



CE EN
388

Č.p.	specifikace
50535	velikost 8"
50536	velikost 9"

12
12

NŮŽ BEZPEČNOSTNÍ

03/2024



Č.p.	Specifikace
16044	

20

systém pro odlamování čepele



NŮŽ ODLAMOVACÍ
protiskluzové pogumování

03/2024



Č.p.	Specifikace
16099	18 mm

1



BROUSEK MULTIFUNKČNÍ 15v1



	30° Anvil	
	45° Anvil	
	50° Anvil	
	23° Bypass	
	35° Bypass	
	65° Bypass	
	Deburr Tool	



Č.p.	Specifikace
45073	

03/2024





1

SADA VRTÁKŮ A BITŮ

vrtáky do dřeva Ø 3 · 4 · 5 · 6 · 8 mm
 vrtáky do kovu Ø 1 · 1,5 · 2 · 2,5 · 3 · 3,5 · 4 · 4,5 · 5 · 5,5 · 6 · 7 · 8 · 10 mm
 vrtáky do zdi Ø 4 · 5 · 6 · 8 · 10 mm
 vrtáky do dřeva ploché Ø 16 · 22 · 25 mm
 vykrúžovací pily Ø 32 · 38 · 44 · 54 mm
 hloubkové dorazy Ø 6 · 8 · 10 mm
 důlčik

měrka na měření průměru vrtáku

bity 25 mm  S 3 · 4 · 4 · 5 · 5 · 6 · 6 · 7
 PH 0 · 0 · 1 · 1 · 2 · 2 · 2 · 3 · 3
 PZ 0 · 0 · 1 · 1 · 2 · 2 · 2 · 3 · 3
 H 2 · 2,5 · 3 · 3,5 · 4 · 5 · 6
 T 10 · 15 · 20 · 25 · 27 · 30 · 40

bity 50 mm  S 4 · 5 · 6 · 6
 PH 1 · 2 · 2 · 3
 PZ 1 · 2 · 2 · 3

šroubovací nástavce  4 · 5 · 6 · 7 · 8 · 9 · 10 · 13 mm
 odjehlovací fréza
 nástavec na bity



100x

Č.p. Specifikace

20340



1

FESTA

PILA JAPONSKÁ



Č.p. Specifikace

24134 250 mm 0,5 mm



10

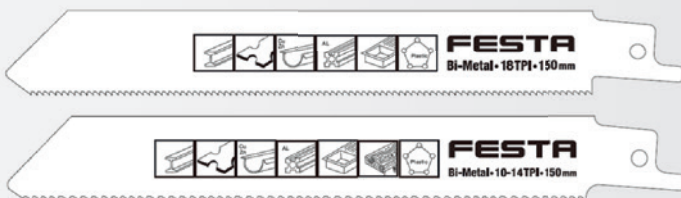

FESTA

RUKOJEŤ PRO PILOVÉ PLÁTKY

· rukojeť + 2x pilový plátek
 · pro pilové plátky do pily ocasky

Č.p. Specifikace

24325



02/2024



1



SADA VYKRUŽOVACÍCH
DIAMANTOVÝCH KORUNEK

- Ø 6 mm
- Ø 8 mm
- Ø 25 mm
- Ø 35 mm
- Ø 40 mm
- Ø 50 mm
- Ø 68 mm

7x **M14**

- keramické obklady a dlažba
- mramor
- žula

- použití bez chlazení vodou

Č.p. Specifikace

24651



1



SADA VYKRUŽOVACÍCH
DIAMANTOVÝCH KORUNEK

- Ø 6 mm
- Ø 8 mm
- Ø 10 mm
- Ø 12 mm
- Ø 20 mm
- Ø 28 mm
- Ø 35 mm
- Ø 45 mm
- Ø 55 mm
- Ø 68 mm

- kotouč řezný / brusný Ø 125 mm x 2,0 mm Ø 22,2 mm
- kotouč řezný Ø 125 mm x 1,2 mm Ø 22,2 mm
- kuželová korunka brusná Ø 0 - 50 mm
- diamantová brusná houba 90 x 55 mm P60

13x **M14**

- keramické obklady a dlažba
- mramor
- žula

- použití bez chlazení vodou

Č.p. Specifikace

24652



1



KORUNKA VYKRUŽOVACÍ DIAMANTOVÁ

M14



- keramické obklady a dlažba
- mramor
- žula



- použití bez chlazení vodou



Č.p.	Specifikace	úchyt	
24620	Ø 6 mm	M14	1
24621	Ø 8 mm	M14	1
24622	Ø 10 mm	M14	1
24623	Ø 12 mm	M14	1
24624	Ø 14 mm	M14	1
24627	Ø 20 mm	M14	1
24630	Ø 28 mm	M14	1
24633	Ø 35 mm	M14	1
24636	Ø 45 mm	M14	1
24638	Ø 55 mm	M14	1
24640	Ø 68 mm	M14	1
24643	Ø 75 mm	M14	1



KORUNKA BRUSNÁ DIAMANTOVÁ

M14



- keramické obklady a dlažba
- mramor
- žula



- použití bez chlazení vodou



Č.p.	Specifikace	úchyt	
24797	Ø 6 - 50 mm		1
24799	Ø 10 - 50 mm		1



KORUNKA VYKRUŽOVACÍ A BRUSNÁ DIAMANTOVÁ

M14



- keramické obklady a dlažba
- mramor
- žula



- použití bez chlazení vodou



Č.p.	Specifikace	úchyt	
24777	Ø 2 - 75 mm		1





FESTA

KORUNKA VYKRUŽOVACÍ DIAMANTOVÁ

M14



- keramické obklady a dlažba
- mramor
- žula



- použití bez chlazení vodou



Č.p.	Specifikace	úchyt	
24677	Ø102 mm	M14	1
24678	Ø125 mm	M14	1

FESTA

VRTÁKY NA SKLO A KERAMIKU, SADA

- Ø 4 mm
- Ø 5 mm
- Ø 6 mm
- Ø 8 mm
- Ø 10 mm

5x



- keramické obklady a dlažba
- mramor
- žula



- použití bez chlazení vodou



Č.p.	Specifikace	
24734		1



FESTA

**CHLADICÍ VOSK
NA DIAMANTOVÉ KORUNKY**



Č.p.	Specifikace	
24710	30 ml	1

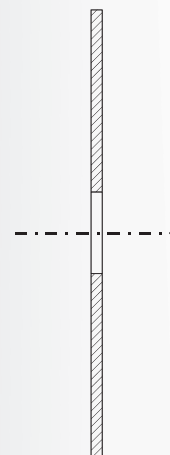
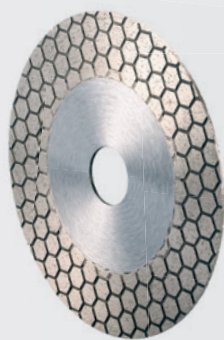

KOTOUČ ŘEZNÝ / BRUSNÝ - DIAMANTOVÝ



- keramické obklady a dlažba
- mramor
- žula



- použití bez chlazení vodou



Č.p.	Specifikace		
21230	Ø 115 mm x 1,8 mm	Ø 22,2 mm	1
21231	Ø 125 mm x 2,0 mm	Ø 22,2 mm	1

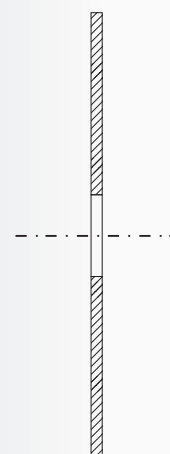

KOTOUČ ŘEZNÝ - DIAMANTOVÝ - TURBO EXTREME



- železobeton
- keramické obklady a dlažba
- mramor
- žula



- použití bez chlazení vodou



Č.p.	Specifikace		
21205	Ø 125 mm x 2,0 mm	Ø 22,2 mm	1
21209	Ø 230 mm x 2,6 mm	Ø 22,2 mm	1

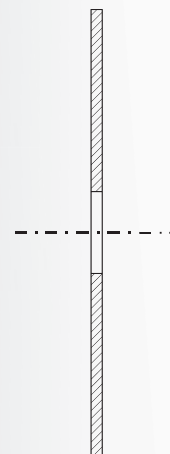

KOTOUČ ŘEZNÝ



- keramické obklady a dlažba
- mramor
- žula



- použití bez chlazení vodou



Č.p.	Specifikace		
21235	Ø 125 mm x 1,2 x 8 mm	Ø 22,2 mm	1

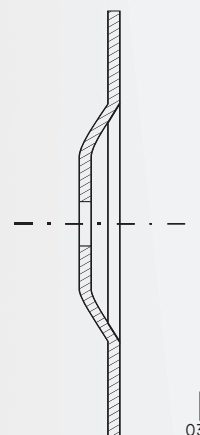
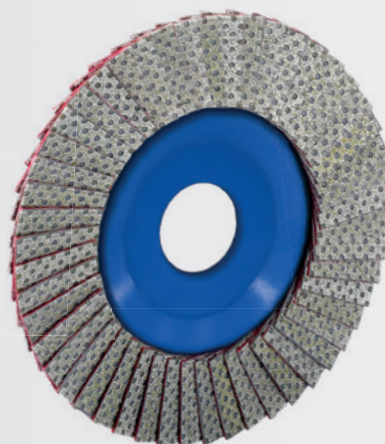
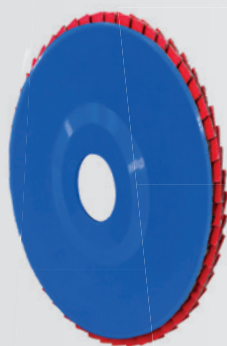

FESTA

**KOTOUČ LAMELOVÝ
- DIAMANTOVÝ**

· pro zábrus dlažeb



- keramické obklady a dlažba
- mramor
- žula



· použití bez chlazení vodou

03/2024



Č.p.	Specifikace			
24647	Ø 115 mm	Ø 22,2 mm	P60	1
24648	Ø 115 mm	Ø 22,2 mm	P120	1
24649	Ø 115 mm	Ø 22,2 mm	P200	1

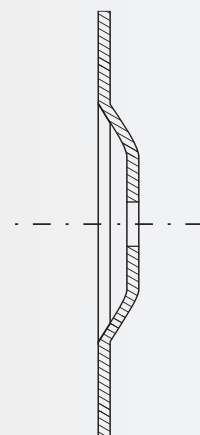

FESTA

KOTOUČ BRUSNÝ



01/2024



Č.p.	Specifikace			
21435	Ø 115 mm	Ø 22,2 mm		1
21436	Ø 125 mm	Ø 22,2 mm		1
21437	Ø 150 mm	Ø 22,2 mm		1



20 mm

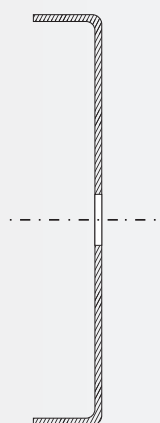

FESTA

KOTOUČ RAŠPLOVÝ



01/2024



Č.p.	Specifikace			
21806	Ø 125 mm	Ø 22,2 mm		10

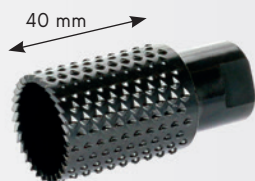

FESTA

RAŠPLE VÁLCOVÁ

M14



Č.p. 21807 Specifikace Ø 30 mm / 60 mm

1

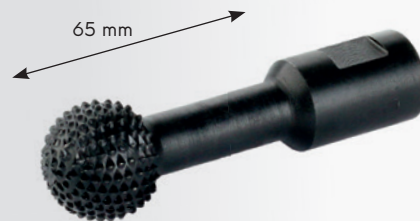

FESTA

RAŠPLE KULOVÁ

M14



Č.p. 21808 Specifikace Ø 30 mm / 105 mm

10



FESTA

VRATIDLO STAVITELNÉ

DIN 1814



Č.p. 20394 Specifikace M5 - M20

10



ORGANIZÉR



Č.p. 55650 Specifikace 375 x 290 x 67 mm



1



FESTA

STĚRKA KOUTOVÁ, NEREZ

INOX



10

Č.p. Specifikace
31517

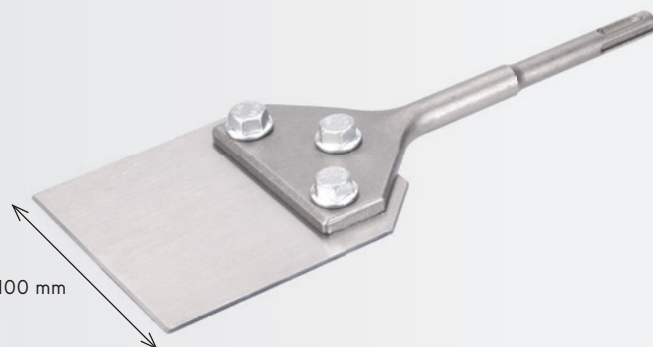

FESTA

SEKÁČ SDS +

SDS+



1

Č.p. Specifikace
20996 250 x 100 mm



STĚRKY SILIKONOVÉ, SADA

4x



1

Č.p. Specifikace
37052

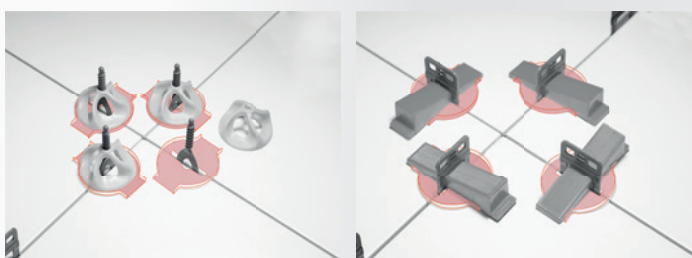

RUČNÍ PĚCHOVADLO

02|2024

Č.p. Specifikace
26740 12 kg

1

NIVELYS
LEVELLING SYSTEMS **FESTA**

PODLOŽKA OCHRANNÁ
POD NIVELAČNÍ SYSTÉM

100x

01|2024



1

Č.p. Specifikace
37192

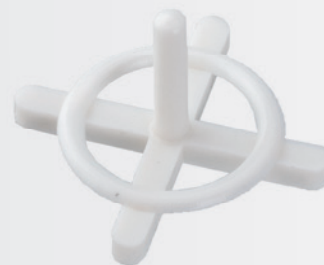

FESTA

KŘÍŽKY NA OBKLADY A DLAŽBU
S ÚCHYTEM

100x



100

Č.p. specifikace
37285 1,5 mm

37286 2 mm

37287 2,5 mm

37288 3 mm

37289 4 mm

100

100

100

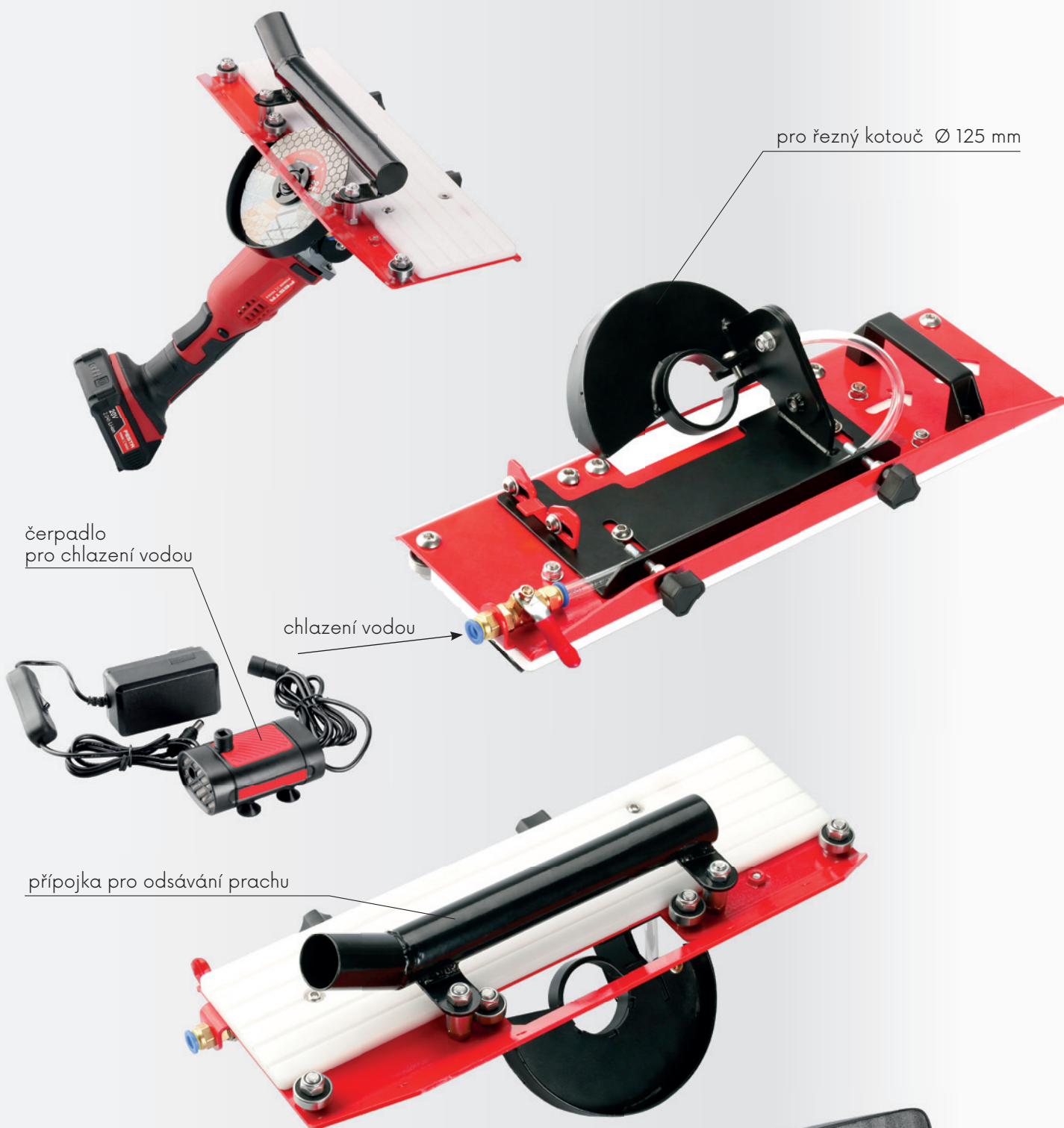
**FESTA****VODICÍ LIŠTA PRO ŘEZÁNÍ DLAŽBY 45°**

Sada obsahuje:

- vodící lištu
- čerpadlo pro vodní chlazení
- náhradní hadičku pro vodní chlazení
- přepravní brašnu

Č.p. Specifikace
24680



02/2024

1



1/4" + 5/8"



KLÍČ PRO ODVZDUŠNĚNÍ TOPENÍ

2x



Č.p. 17454 Specifikace 5 x 5 mm

1

STATIV

ALU



Č.p. 26219 Specifikace 60 - 150 cm 1/4" + 5/8"

1



FESTA

NÁSTAVEC NA ODSÁVÁNÍ PRACHU

Č.p. 28267 Specifikace max. 70 mm

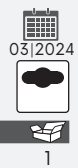

1



GRILOVACÍ VIDLICE - TELESKOPIČKÁ

INOX



Č.p. 43094 Specifikace

1

DRŽÁK NA KLADIVA A PALICE

Zn



No. 81188 specifications max 2 kg

1

GRAFICKÉ SYMBOLY POUŽITÉ V KATALOGU

PIKTOGRAMY SPECIFIKACE PRODUKTŮ



SPECIFIKACE POUŽITÍ

- dřevo
- keramika
- plasty
- hliník
- měď
- kámen
- sklo
- zdivo
- papír
- ocel
- kompozit
- obklady
- nerezová ocel
- omítka
- dřevo se šrouby, hřebíky
- sádrokarton
- pro vrtání do materiálů s pevností v tahu do ...

- S2** · funkční části z vysoce legované nástrojové oceli S2
- HSS** · funkční části vyrobeny z rychlořezné oceli
- Cr-Mo** · funkční části z chrom-molybdenové oceli
- CrV** · funkční části z chrom-vanadové oceli
- INOX** · funkční části z nerezavějící oceli
- NYLON** · nylonová rukojeť
- TEFLON** · teflonový povrch
- Zn** · zinkováno
- TiN** · povrch potažen nitridem titanu
- HRC 58-61** · tvrdost materiálu funkčních částí podle Rockwella
- 40% PES** · složení materiálu - obsahuje 40% polyesteru
- PES** · složení materiálu - vyrobeno z polyesteru
- DIAMANT** · diamantová zrna na povrchu funkčních částí
- MAGNETICKÉ** · magnetické

- SDS+** · způsob uchycení
- SDS MAX** · způsob uchycení
- M14** · způsob uchycení
- 72T** · počet zubů ráčny
- 36T** · počet zubů ráčny
- 1/2"** · velikost uchycení
- 3/4"** · velikost uchycení
- 1/4"** · velikost uchycení
- 27 dB** · údaj o výši ochrany sluchu
- DIN 3113** · splňuje uvedenou normu
- IP 54** · splňuje uvedenou normu
- 32x** · počet produktů v sadě
- II. class** · splňuje uvedenou třídu přesnosti
- III. class** · splňuje uvedenou třídu přesnosti
- SNOW** · vhodné do chladného počasí
- ERGO HANDLE** · ergonomická rukojeť
- HOBBY** · pro hobby použití
- 2x AAA** · počet a typ baterií
- UV STABLE** · odolné proti UV záření
- RUBBER ENDS** · nárazuvzdorné gumové koncovky



SPECIFIKACE BALENÍ

- BOX** · baleno v krabici
- HANG** · balení se závěsem
- MOQ 12** · minimální objednatelné množství
- 5** · počet kusů v balení

SPECIFIKACE PRODUKTŮ VODNÍHO PROGRAMU

- volitelný tvar proudu vody
- minimální a maximální tlak
- maximální průtok vody
- zavlažovaná plocha
- velikost závitů pro připojení adaptéru
- průměr hadice pro připojení do rychlospojky



2024



PROFESIONÁLNÍ  NÁŘADÍ



festatools



#festatools



festatools

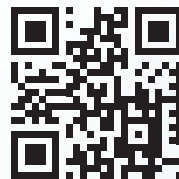

www.festa.tools

HORIZONT.

FESTA
POWER X TOOLS

FESTA
AQUATIC

KDS KOMELON.

ROSA

Stahlberg

Lescha SUPER PRO

