

RAIDER®



2020-2021



Евромастер Импорт-Експорт ООД е основана през 1992 г. и днес заема водещо място на пазара на професионалните и хоби инструменти в България, постигайки устойчив растеж през годините.

Нашата мисия, вече 28 години, е да задоволяваме потребителското търсене, спазвайки Европейските стандарти за качество, като произвеждаме, доставяме, развиваме и разширяваме асортимента ни от висококачествени продукти.

Най-важните предпоставки за успех на компанията са: **Опитът**, натрупан от изучаване на световните тенденции в търговията с електро и механични инструменти; **Куражът**, да се следва по-трудния, но в перспектива по-успешен път на създаване, развиване и налагане на собствени марки; **Доверието** към всеки служител на фирмата и всеки бизнес партньор.

Ние знаем в какво сме най-добри и сме насочили цялата си енергия към затвърждаването на позициите ни като лидер на българския пазар. Фокусирани сме върху това да вършим прекрасно работата си, да създаваме инструменти и машини, които да направят живота Ви по-лек и по-добър. Стремим се да бъдем блестящи във всеки детайл, давайки изключителна стойност на нашите продукти.

Така постигаме своите успехи.

Euromaster Import - Export Ltd. was founded in 1992 and today occupies a leading position in the market of professional and hobby tools in Bulgaria, achieving a sustainable level of growth over the years.

Our mission for 28 years now, has been to meet the consumer demand, complying with European quality standards by manufacturing, supplying, developing and expanding our range of high quality products.

The most important prerequisites for the company's success are:

Experience gained from the study of global trends in the trade of power and hand tools;

Courage to follow the more difficult, but in perspective the more successful way of creating,

Development and enforcement of own brands; Trust in each company employee and business partner.

"We know what we are good at and direct all our energy to strengthen our position as a leader on the Bulgarian market.

We are focused on doing our job perfectly, to create hand and power tools and to make your life easier and better. We

strive to be brilliant in every detail, providing exceptional value to our products.

That is how we achieve our successes."

RAIDER®

Pro

R20 System

20
YEARS
ANNIVERSARY



**ONE BATTERY
FITS ALL**

CORDLESS DRILL RDP-SCD20

• [BG] Акумулаторна бормашина • [RO] Masina de gaurit si insurubat • [SR] Bušilica • [MK] Батериска бормашина • [RU] Аккумуляторная дрель
 • [SL] Akumulatorski vrtnik vijasnik • [EL] Δραπανοκατσαβίδα • [HR] Akumulatorska bušilica • [FR] Perceuse sans fil • [IT] Trapano senza cordone
 • [ES] Taladro inalámbrico sin batería y cargador • [PT] Aparafusadora

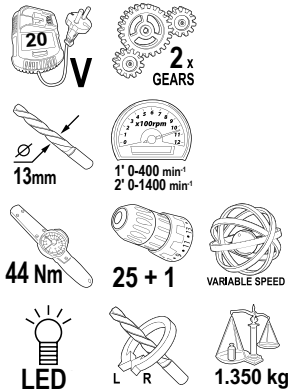

TWO GEARS



CHARGING TIME
1 HOUR



ERGONOMIC
SOFT HANDLE

RDP-SCD20 SOLO

| Art.No | gross weight | in cartoon | barcode |
|--------|--------------|------------|---------------|
| 030130 | 1.500 kg | 10 pcs | 3800123168185 |

RDP-SCD20 WITH BATTERY 1.5Ah SET

| Art.No | gross weight | in cartoon | barcode |
|--------|--------------|------------|---------------|
| 030211 | 2.320 kg | 10 pcs | 3800972005372 |

CORDLESS DRILL RDP-SCD20S

• [BG] Акумулаторна бормашина • [RO] Masina de gaurit si insurubat • [SR] Bušilica • [MK] Батериска бормашина • [RU] Аккумуляторная дрель
 • [SL] Akumulatorski vrtnik vijasnik • [EL] Δραπανοκατσαβίδα • [HR] Akumulatorska bušilica • [FR] Perceuse sans fil • [IT] Trapano senza cordone
 • [ES] Taladro inalámbrico sin batería y cargador • [PT] Aparafusadora

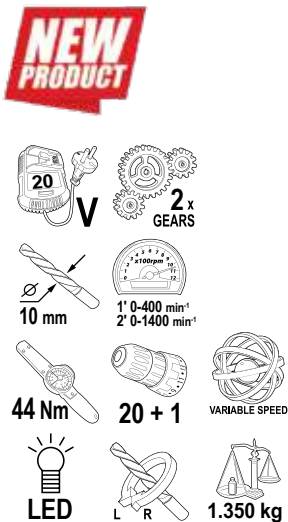

TWO GEARS



CHARGING TIME
1 HOUR



ERGONOMIC
SOFT HANDLE

RDP-SCD20S SOLO

| Art.No | in cartoon | barcode |
|--------|------------|---------------|
| 030220 | 10 | 3800972017191 |

RDP-SCD20S WITH 1 BATTERY 2Ah SET IN CASE

| Art.No | barcode |
|--------|---------------|
| 030219 | 3800972017184 |

RDP-SCD20S WITH 2 BATTERIES 2Ah SET IN CASE

| Art.No | barcode |
|--------|---------------|
| 030218 | 3800972017177 |

CORDLESS HAMMER DRILL - DRIVER RDP-SCDI20

• [BG] Бормашина ударна акумулаторна • [RO] Masina de gaurit si insurubat cu percutie • [SR] Bušilica • [MK] Батериска бормашина • [RU] Аккумуляторная дрель • [SL] Akumulatorski vrtnik vijasnik
 • [EL] Δραπανοκατσαβίδα • [HR] Akumulatorska bušilica • [FR] Perceuse sans • [IT] Trapano senza cordone • [ES] Taladro inalámbrico • [PT] Aparafusadora de percussão

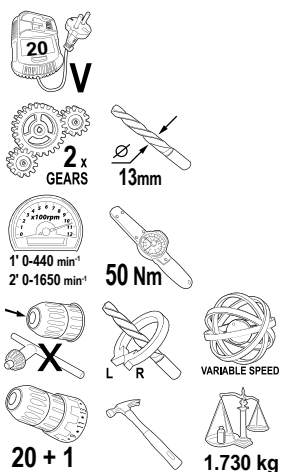

IMPACT FUNCTION



TWO GEARS



CHARGING TIME
1 HOUR



ERGONOMIC
SOFT HANDLE

RDP-SCDI20 SOLO

| Art.No | gross weight | in cartoon | barcode |
|--------|--------------|------------|---------------|
| 030131 | 1.920kg | 5 pcs | 3800123168277 |

RDP-SCDI20 WITH 2 BATTERIES 2Ah SET IN CASE

| Art.No | gross weight | in cartoon | barcode |
|--------|--------------|------------|---------------|
| 030208 | 4.250 kg | 4 pcs | 3800972005341 |

CORDLESS HAMMER DRILL RDP-SCDI20S

- [BG] Бормашина ударна акумулаторна • [RO] Masina de gaurit si insurubat cu percutie • [SR] Bušilica • [MK] Батериска бормашина
- [RU] Акумуляторная дрель • [SL] Akumulatorski vrtnik vijacnik • [EL] Δραπανοκατσαβίδο • [HR] Akumulatorska bušilica • [FR] Perceuse sans
- [IT] Trapano senza cordone • [ES] Taladro inalámbrico • [PT] Aparafusadora de percussão



20 V
2 x GEARS
13 mm
1' 0-440 min⁻¹
2' 0-1650 min⁻¹
50 Nm
VARIABLE SPEED
20 + 1
1.720 kg



IMPACT FUNCTION
TWO GEARS
CHARGING TIME 1 HOUR
ERGONOMIC SOFT HANDLE

RDP-SCDI20S SOLO

| Art.No | gross weight | barcode |
|--------|--------------|---------------|
| 030217 | 1.920 kg | 3800972017160 |

RDP-SCDI20S WITH 2 BATTERIES 2Ah SET IN CASE

| Art.No | gross weight | barcode |
|--------|--------------|---------------|
| 030216 | 4.250 kg | 3800972017153 |

AUTO TOUCH CORDLESS DRILL WITHOUT BATTERY AND CHARGER SOLO RDP-SCDA20

- [BG] Бормашина акумулаторна без батерия и зарядно • [RO] Masina si insurubat cu percutie fără baterie și încărcător • [SR] Bušilica bez baterija i punjač • [MK] Батериска бормашина без батерия и полнач
- [RU] Акумуляторная дрель без аккумулятора и зарядного устройства • [SL] Akumulatorski vrtnik vijacnik brez baterije in polnilnika • [EL] Δραπανοκατσαβίδο χωρίς μπαταρία και φορτιστή
- [HR] Akumulatorska bušilicabez baterije i punjača • [FR] Perceuse sans fil sans batterie et chargeur • [IT] Trapano senza cordone senza batteria e caricabatterie • [ES] Taladro inalámbrico sin batería y cargador
- [PT] Aparafusadora de percussão sem bateria e carregador

20 V
10mm
1' 0-440 min⁻¹
2' 0-1650 min⁻¹
50 Nm
VARIABLE SPEED
1.450 kg



AUTO TOUCH

RDP-SCDA20 SOLO

| Art.No | barcode |
|--------|---------------|
| 030222 | 3800972017214 |

BRUSHLESS CORDLESS DRILL WITH BATTERY AND CHARGER RDP-SBCD20 SET

- [BG] Акумуляторна бормашина безчеткова с батерия и зарядно • [RO] Masina de gaurit si insurubat cu baterie și încărcător • [SR] Bušilica sa akumulatorom s baterija i punjač • [MK] Батериска бормашина со батерия и полнач
- [RU] Акумуляторная дрель с аккумулятором и зарядным устройством • [SL] Akumulatorski vrtnik vijacnik z baterijo in polnilnikom • [EL] Δραπανοκατσαβίδο με μπαταρία και φορτιστή
- [HR] Akumulatorska bušilicas baterijom i punjačem • [FR] Perceuse sans fil avec batterie et chargeur • [IT] Trapano senza cordone con batteria e caricabatterie • [ES] Taladro inalámbrico con batería y cargador
- [PT] Aparafusadora com bateria e carregador

20 V
2 Ah
Li-Ion
2 x GEARS
VARIABLE SPEED
10mm
1' 0-440 min⁻¹
2' 0-1650 min⁻¹
LED
44 Nm
20 + 1
3.500kg



2 BATTERIES
BRUSHLESS

TWO GEARS
ERGONOMIC SOFT HANDLE

CHARGING TIME 1 HOUR

RDP-SBCD20 SET

| Art.No | barcode |
|--------|---------------|
| 030215 | 3800972017146 |

BRUSHLESS CORDLESS DRYWALL SCREWDRIVER SOLO RDP-SBES20

• [BG] Акумулаторен безщетков винтоверт за гипсокартон без батерия и зарядно • [RO] Surubelnita cu impact fără baterie și încărcător • [SR] Odvijač • [MK] Батериска штрафилица • [RU] Акумулаторная отвёртка • [SL] Akumulatorski izvijač zavijake zagrips plošče • [EL] Κατσαβίδι για γυψοσανίδες • [HR] Akumulatorski odvijač • [FR] Tournevis à cloisons sèches • [IT] Cacciavite per cartongesso • [ES] Desegnilo drywall • [PT] Aparafusadora p/ gesso cartonado

**NEW
PRODUCT**

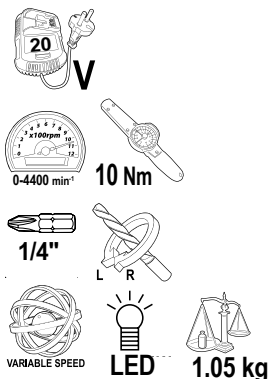

BRUSHLESS

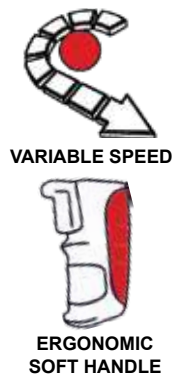

RDP-SBES20 SOLO

| Art.No | gross weight | in cartoon | barcode |
|--------|--------------|------------|---------------|
| 030159 | 1.170 kg | 5 | 3800972018464 |

CORDLESS HEX IMPACT DRIVER SOLO RDP-SHID20

• [BG] Винтоверт ударен акумулаторен без батерия и зарядно • [RO] Surubelnita cu impact fără baterie și încărcător • [SR] Odvijač bez baterija i punjač • [MK] Батериска штрафилица без батерија и полнач • [RU] Акумулаторная отвёртка без аккумулятора и зарядного устройства • [SL] Akumulatorski izvijač zavijake brez baterije in polnilnika • [EL] Δραπανοκατσαβίδο χωρίς μπαταρία και φορτιστή • [HR] Akumulatorska odvijač bez baterije i punjača • [FR] Perceuse sans fil sans batterie et chargeur • [IT] Trapano senza cordone senza batteria e caricabatterie • [ES] Taladro inalámbrico sin batería y cargador • [PT] Aparafusadora de impacto/caixa a bateria

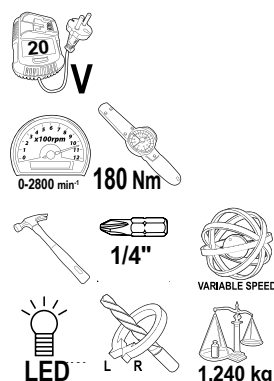

**METAL
GEAR BOX**



RDP-SHID20 SOLO

| Art.No | gross weight | in cartoon | barcode |
|--------|--------------|------------|---------------|
| 030132 | 1.580 kg | 5 pcs | 3800123168192 |

CORDLESS IMPACT WRENCH SOLO RDP-SCIW20

• [BG] Гайковерт ударен акумулаторен без батерия и зарядно • [RO] Masina de insurubat cu impact fără baterie și încărcător • [SR] Bušilica bez baterija i punjač • [MK] Батериска бормашина без батерија и полнач • [RU] Акумулаторная дрель без аккумулятора и зарядного устройства • [SL] Akumulatorski vrtalnik vijacnik brez baterije in polnilnika • [EL] Δραπανοκατσαβίδο χωρίς μπαταρία και φορτιστή • [HR] Akumulatorska bušilicabez baterije i punjača • [FR] Perceuse sans fil sans batterie et chargeur • [IT] Trapano senza cordone senza batteria e caricabatterie • [ES] Taladro inalámbrico sin batería y cargador • [PT] Aparafusadora de impacto/caixa a bateria

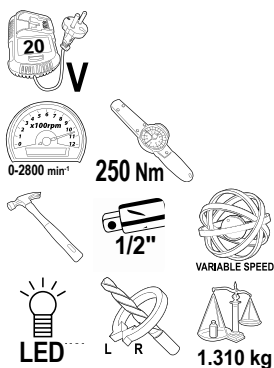

**METAL
GEAR BOX**



RDP-SCIW20 SOLO

| Art.No | gross weight | in cartoon | barcode |
|--------|--------------|------------|---------------|
| 030133 | 1.640 kg | 5 pcs | 3800123168215 |

CORDLESS IMPACT WRENCH SOLO RDP-SCIW20S

• [BG] Гайковерт ударен акумулаторен без батерия и зарядно • [RO] Masina de insurubat cu impact fără baterie și încărcător • [SR] Bušilica bez baterija i punjač • [MK] Батериска бормашина без батерија и полнач • [RU] Акумуляторная дрель без аккумулятора и зарядного устройства • [SL] Akumulatorski vrtalnik vijacnik brez baterije in polnilnika • [EL] Δραπανοκατασβίδο χωρίς μπαταρία και φορτιστή • [HR] Akumulatorska bušilicabez baterije i punjača • [FR] Perceuse sans fil sans batterie et chargeur • [IT] Trapano senza cordone senza batteria e caricabatterie • [ES] Taladro inalambrico sin batería y cargador • [PT] Aparafusadora de impacto/caixa a bateria

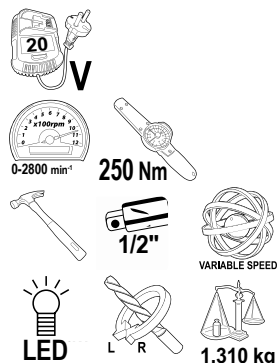

**NEW
PRODUCT**

**ERGONOMIC
SOFT HANDLE**
RDP-SCIW20S SOLO

| Art.No | barcode |
|--------|---------------|
| 030221 | 3800972017207 |

CORDLESS IMPACT WRENCH SOLO RDP-SCIW20-5

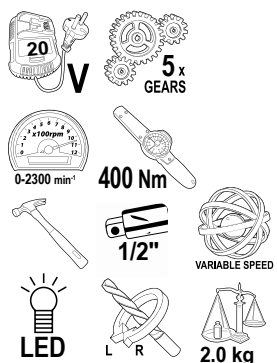
• [BG] Гайковерт ударен акумулаторен без батерия и зарядно • [RO] Masina de insurubat cu impact fără baterie și încărcător • [SR] Bušilica bez baterija i punjač • [MK] Батериска бормашина без батерија и полнач • [RU] Акумуляторная дрель без аккумулятора и зарядного устройства • [SL] Akumulatorski vrtalnik vijacnik brez baterije in polnilnika • [EL] Δραπανοκατασβίδο χωρίς μπαταρία και φορτιστή • [HR] Akumulatorska bušilicabez baterije i punjača • [FR] Perceuse sans fil sans batterie et chargeur • [IT] Trapano senza cordone senza batteria e caricabatterie • [ES] Taladro inalambrico sin batería y cargador • [PT] Aparafusadora de impacto/caixa a bateria

**METAL
GEAR BOX**

**ELECTRONIC TORQUE
CONTROL**

**ERGONOMIC
SOFT HANDLE**
RDP-SCIW20-5 SOLO

| Art.No | gross weight | in carton | barcode |
|--------|--------------|-----------|---------------|
| 030134 | 2.250 kg | 5 pcs | 3800123168253 |

BRUSHLESS CORDLESS ROTARY HAMMER SOLO RDP-SBRH20

• [BG] Перфоратор акумулаторен безчетков без батерия и зарядно • [RO] Ciocan rotorpercutor fără baterie și încărcător • [SR] Bežični čekić za vuču bez baterija i punjač • [MK] Батериски ротирачки чекан без батерија и полнач • [RU] Акумуляторен поворотный молоток без аккумулятора и зарядного устройства • [SL] Brežični vrtljivi kladiv brez baterije in polnilnika • [EL] Περιστροφόμενο σφύρι χωρίς μπαταρία και φορτιστή • [HR] Bežični okretni čekić bez baterije i punjača • [FR] Marteau rotatif sans fil sans batterie et chargeur • [IT] Martello perforatore senza batteria e caricabatterie • [ES] Senorda rotacion martelo sin batería y cargador • [PT] Martelo perfurador a bateria

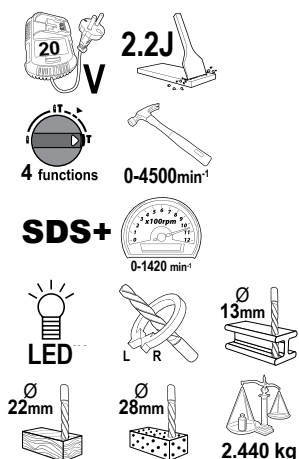
BRUSHLESS

SDS+

FOUR FUNCTION
RDP-SBRH20 SOLO

| Art.No | gross weight | in carton | barcode |
|--------|--------------|-----------|---------------|
| 030151 | 2.710 kg | 8 | 3800972012349 |

CORDLESS ROTARY HAMMER

RDP-SRH20 SOLO

ART. NO. 030135

EAN 13: 3800123168239



1.2J



SDS+



VARIABLE SPEED



1.650 kg

R20 SYSTEM

PRO & POWER TOOLS

PNEUMATICS

ACCESSORIES



CORDLESS HANDLE MIXER SOLO RDP-SHM20

• [BG] Акумулаторен миксер без батерия и зарядно • [RO] Amestecator fără baterie și încărcător • [SR] Mešač bez baterija i punjač • [MK] Мешалка без батерија и полнач • [RU] Перемешиватель без аккумулятора и зарядного устройства • [SL] Mešalnik brez baterije in polnilnika • [EL] Δραπάνο Αναδευτήρας σφύρι χωρίς μπαταρία και φορτιστή • [HR] Miješalica bez baterije i punjača • [FR] Mélangeur à poignée fil sans batterie et chargeur • [IT] Maneggiare il mixer senza batteria e caricabatterie • [ES] Manlibro miksaño sin batería y cargador • [PT] Misturadora manual

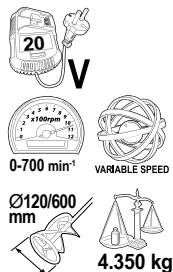
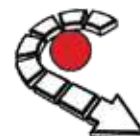
**NEW
PRODUCT**

VARIABLE SPEED

**ERGONOMIC
SOFT HANDLE**

RDP-SHM20 SOLO

| Art.No | gross weight | in carton | barcode |
|--------|--------------|-----------|---------------|
| 030152 | 4.850 kg | 2 pcs | 3800972014282 |

CORDLESS JIG SAW RDP-SJS20

• [BG] Прободен трион акумулаторен • [RO] Ferstrau pendular • [SR] Ubodna testera sa akumulatorom • [MK] Акумулаторска убодна пила • [RU] Акумулаторный лобзик • [SL] Akumulatorska vbodna žaga • [EL] Ξύγα μπαταρίας • [HR] Akumulatorska ubodna pila • [FR] Scie sauteuse sans fil • [IT] Seghetto alternativo • [ES] Inalámbrico jigsaw • [PT] Rebarbadora com bateria

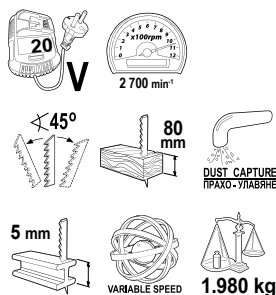
PENDULUM FUNCTION

QUICK CHANGE SYSTEM

RDP-SJS20 SOLO

| Art.No | gross weight | in carton | barcode |
|--------|--------------|-----------|---------------|
| 030137 | 2.200 kg | 5 pcs | 3800123168246 |

RDP-SJS20 WITH 1 BATTERY 2Ah SET IN CASE

| Art.No | gross weight | in carton | barcode |
|--------|--------------|-----------|---------------|
| 030210 | 3.100 kg | 4 pcs | 3800972005365 |

CORDLESS RECIPROCATING SAW SOLO RDP-SRS20

• [BG] Акумулаторен саблевиден трион без батерия и зарядно • [RO] Ferastrau tip sabie fără baterie și încărcător • [SR] Sabljasta testera batteri bez baterija i punjač • [MK] Акумулаторска пила сабјарка без батерија и полнач • [RU] Акумулаторен маятниковый лобзик без аккумулятора и зарядного устройства • [SL] Brezžični nihajna vbodna žaga brez baterije in polnilnika • [EL] Πριονί σεγα χωρίς μπαταρία και φορτιστή • [HR] Bežični recipročna pila bez baterije i punjača • [FR] Scie alternative sans fil sans batterie et chargeur • [IT] Sega alternativa senza batteria e caricabatterie • [ES] Sierra reciproca inalambrica sin batería y cargador • [PT] Serra sabre sem bateria e carregador

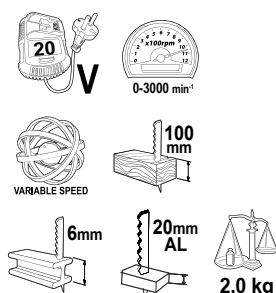
**22cm
SAW BLADE STROKE**

QUICK CHANGE SYSTEM

RDP-SRS20 SOLO

| Art.No | gross weight | in carton | barcode |
|--------|--------------|-----------|---------------|
| 030138 | 2.230 kg | 4 pcs | 3800123168260 |

CORDLESS ANGLE GRINDER

RDP-SAG20 WITH 1 BATTERY 2AH SET IN CASE

ART. NO. 030209

EAN 13: 3800972005358



M14



RDP-SAG20 SOLO

ART. NO. 030136

EAN 13: 3800123168154

ACCESSORIES PNEUMATICS PRO & POWER TOOLS R20 SYSTEM

BRUSHLESS CORDLESS ANGLE GRINDER RDP-SBAG20

• [BG] Ъглошлайф акумулаторен безчетков • [RO] Polizor unghiular • [SR] Brusilica ugaona sa akumulatomom • [MK] Батериска брусилка • [RU] Аккумуляторная угловая шлифовальная машина
• [SL] Kotni brusilnik • [EL] Γωνιακος τροχος μπαταριας • [HR] Aku kutna brusilica • [FR] Meuleuse d'angle sans • [IT] Smerigliatrice angolare • [ES] Amoladora angular • [PT] Rebarbadora

**NEW
PRODUCT**
BRUSHLESS

DUST FILTER

RDP-SBAG20 SOLO

| Art.No | barcode |
|--------|---------------|
| 030223 | 3800972017221 |

RDP-SBAG20 WITH 1 BATTERY 4Ah SET IN CASE

| Art.No | barcode |
|--------|---------------|
| 030224 | 3800972017238 |

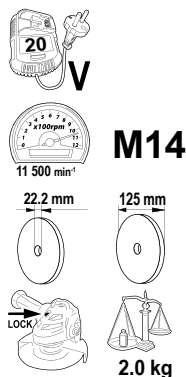

CORDLESS CIRCULAR SAW SOLO RDP-SCS20

• [BG] Циркуляр акумулаторен без батерия и зарядно • [RO] Ferastrau circular fără baterie și încărcător • [SR] Bežični cirkular bez baterija i punjač • [MK] Батериски циркулар без батерија и полнач
• [RU] Аккумуляторная дисковая пила без аккумулятора и зарядного устройства • [SL] Brezžična krozna zaga brez baterije in polnilnika • [EL] Δισκοτροπινο μπαταριας χωρις μπαταρια και φορτιστη
• [HR] Aku kružna pila cirkular bez baterije i punjača • [FR] Scie circulaire sans fil sans batterie et chargeur • [IT] Sega circolare cordone senza batteria e caricabatterie • [ES] Sierra circular inalámbrica sin batería y cargador • [PT] Serra circular sem bateria e carregador

LASER

**ADJUSTABLE
CUTTING DEPTH
AND CUTTING ANGLE 45°**

RDP-SCS20 SOLO

| Art.No | gross weight | in carton | barcode |
|--------|--------------|-----------|---------------|
| 030139 | 3.600 kg | 2 pcs | 3800123168208 |

FOR RDP-SCS20

| Art.No | gross weight | in carton | barcode |
|--------|--------------|-----------|---------------|
| 163143 | 0.240 kg | 50 pcs | 3800972005396 |

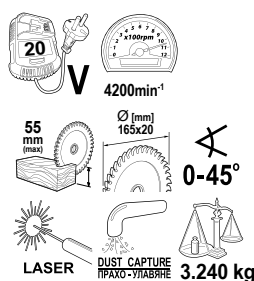

CORDLESS RANDOM ORBIT SANDER SOLO RDP-SRSA20

• [BG] Ексцентършлайф акумулаторен без батерия и зарядно • [RO] Slefuitor orbital fără baterie și încărcător • [SR] Brusilica rotaciona bez baterija i punjač • [MK] Ексцентрична брусилка без батерија и полнач
• [RU] Эксцентрикковые шлифовальные машины без аккумулятора и зарядного устройства • [SL] Ekscentrični brusilnik brez baterije in polnilnika • [EL] Εκκεντρο τριβειο χωρις μπαταρια και φορτιστη
• [HR] Ekscentrična brusilica bez baterije i punjača • [FR] Ponceuse excentrique sans fil sans batterie et chargeur • [IT] Levigatrice orbitale senza batteria e caricabatterie • [ES] Lijadora de órbita inalámbrica sin batería y cargador • [PT] Lixadeira de órbita aleatória sem fio sem bateria e carregador

VELCRO

DUST AWAY

RDP-SRSA20

| Art.No | gross weight | in carton | barcode |
|--------|--------------|-----------|---------------|
| 030140 | 1.200 kg | 4 pcs | 3800123168161 |

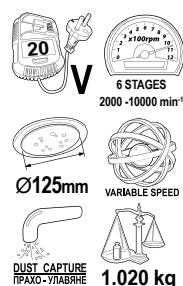

CORDLESS MULTI-TOOL SOLO RDP-SOMT20

• [BG] Многофункционален инструмент без батерия и зарядно • [RO] Unealta multifunctionala fără baterie și încărcător • [SR] Višenamenski alat bez baterija i punjač • [MK] Повеќенаменски алат без батерија и полнач • [RU] Многофункциональный инструмент без аккумулятора и зарядного устройства • [SL] Večnamensko orodje brez baterije in polnilnika • [EL] Πολυεργαλείο μπαταρίας χωρίς μπαταρία και φορτιστή • [HR] Višenamjenski alat bez baterije i punjača • [FR] Outil multifonctionnel sans fil sans batterie et chargeur • [IT] Multi-utensile oscillante senza batteria e caricabatterie • [ES] Herramienta multifuncional inalámbrica sin batería y cargador • [PT] Multi-ferramenta oscilante sem fio sem bateria e carregador

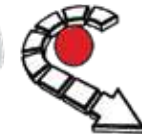
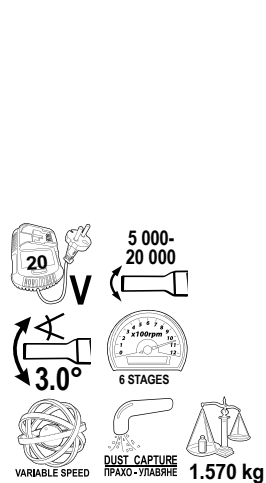

VARIABLE SPEED



QUICK CHANGE



CUTTING AND GRINDING



2 LEDs

RDP-SOMT20 SOLO

| Art.No | gross weight | in cartoon | barcode |
|--------|--------------|------------|---------------|
| 030141 | 1.750 kg | 4 pcs | 3800123168178 |

CORDLESS HOT MELT GLUE GUN SOLO RDP-SGLG20

• [BG] Пистолет за топло лепене акумулаторен без батерия и зарядно • [RO] Pistol de lipit fara acumulator si incarcator • [SR] Akumulatorski pištolj za lepljenje bez baterije i punjača • [MK] Безжичен лепак пистолет без батерија и полнач • [RU] Аккумуляторный клеевой пистолет без аккумулятора и зарядного устройства • [SL] Akumulatorska pištola za lepljenje brez baterije in polnilnika • [EL] Επαναφορτιζόμενο πιστόλι κόλλησης χωρίς μπαταρία και φορτιστή • [HR] Akumulatorski pištolj za lijepljenje bez baterije i punjača • [FR] Pistolet à colle sans fil sans batterie et chargeur • [IT] Pistola per colla a batteria senza batteria e caricabatterie • [ES] Pafilata gluilo sen baterio kaj senšargilo sin batería y cargador • [PT] Arma de cola sem fio sem bateria e carregador

NEW PRODUCT



DUSE DIAMETER
Ø 3 mm

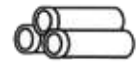

GLUE STICKS
Ø 11 mm

RDP-SGLG20 SOLO

| Art.No | gross weight | in cartoon | barcode |
|--------|--------------|------------|---------------|
| 030154 | 0.660 kg | 4 pcs | 3800972014428 |

CORDLESS HEAT GUN SOLO RDP-SHG20

• [BG] Пистолет за горещ въздух акумулаторен без батерия и зарядно • [RO] Pistol cu aer cald fără baterie și încărcător • [SR] Pištolj za vreli vazduh bez baterije i punjača • [MK] Фен без батерија и полнач • [RU] Пистолет горячего воздуха без аккумулятора и зарядного устройства • [SL] Vroca zrasna pištola brez baterije in polnilnika • [EL] Πιστόλι φερμου αερα χωρίς μπαταρία και φορτιστή • [HR] Pištolj za vrući zrak bez baterije i punjača • [FR] Arbre à air chaud sans batterie et chargeur • [IT] Pistola aria calda senza batteria e caricabatterie • [ES] Pistola de aire caliente sin batería y cargador • [PT] Soprador de ar quente sem bateria e carregador

NEW PRODUCT



0 - 550°C



RDP-SHG20 SOLO

| Art.No | barcode |
|--------|---------------|
| 030160 | 3800972018884 |

CORDLESS COMBI AIR STAPLER AND NAILER SOLO RDP-SST20

• [BG] Акумулаторен комбиниран такер без батерия и зарядно • [RO] Capsator fără fir combinat fără baterie și încărcător • [SR] Kombinovani akumulatorski klamerica bez baterije i punjača • [MK] Комбиниран безжичен спојувач без батерија и полнач • [RU] Беспроводной степлер комбинированный без аккумулятора и зарядного устройства • [SL] Kombinirana akumulatorska spenjača brez baterije in polnilnika • [EL] Συρραπτικό συρραπτικό συνδυασμένο μπαταρία και φορτιστή • [HR] Kombinirani bežični klamerica bez baterije i punjača • [FR] Agrafeuse sans fil combinée • [IT] Cucitrice cordless combinata senza batteria e caricabatterie • [ES] Senkabila stapler kombinata sin batería y cargador • [PT] Grampeador sem fio combinado sem bateria e carregador

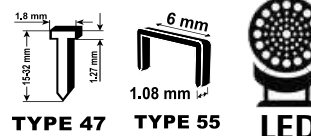
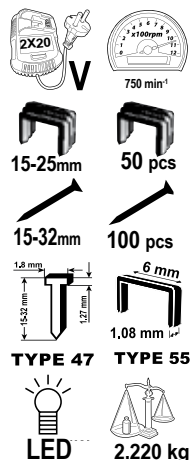

RDP-SST20 SOLO

| Art.No | gross weight | in carton | barcode |
|--------|--------------|-----------|---------------|
| 030153 | 2.470 kg | 4 pcs | 3800972014411 |

STAPLES FOR CORDLESS STAPLER RDP-SST20

• [BG] Скоби за акумулаторен пневматичен такер • [RO] Capse pentru capsator fără fir RDP-SST20 • [SR] Držači za bežični spenjač RDP-SST20 • [MK] Муниција за хефталка RDP-SST20 • [RU] Скобы для беспроводного степлера RDP-SST20 • [SL] Sponke RDP-SST20 • [EL] Συρραπτικά για ασύρματο συρραπτικό RDP-SST20 • [HR] Klamerice za klamerica RDP-SST20 • [FR] Sauterelles RDP-SST20 • [IT] Morsetti di inclinazione RDP-SST20 • [ES] Grapoj por sendrata stanpilo RDP-SST20 • [PT] Grampos para grampeador sem fio RDP-SST20



| Art.No | H (mm) | W (mm) | D (mm) | barcode |
|--------|--------|--------|--------|---------------|
| 511412 | 14 | 6 | 1.08 | 3800972015661 |
| 511413 | 16 | 6 | 1.08 | 3800972015678 |
| 511414 | 20 | 6 | 1.08 | 3800972015685 |
| 511415 | 25 | 6 | 1.08 | 3800972015692 |

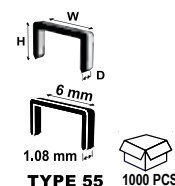

NAILS FOR CORDLESS STAPLER RDP-SST20

• [BG] Пирони за акумулаторен такер • [RO] Cuie pentru capsator fără fir RDP-SST20 • [SR] Klamerice za pneumatsku heftalicu RDP-SST20 • [MK] Муниција за хефталка RDP-SST20 • [RU] Гвозди для беспроводного степлера RDP-SST20 • [SL] Sponke RDP-SST20 • [EL] Καρφιά για ασύρματο συρραπτικό RDP-SST20 • [HR] Klamerice za RDP-SST20 • [FR] Sauterelles RDP-SST20 • [IT] Morsetti di inclinazione RDP-SST20 • [ES] Šlosiljoj por sendrata grapilo RDP-SST20j • [PT] Pregos para grampeador sem fio RDP-SST20



| Art.No | H (mm) | D (mm) | barcode |
|--------|--------|--------|---------------|
| 511416 | 15 | 1.08 | 3800972015708 |
| 511417 | 20 | 1.08 | 3800972015715 |
| 511418 | 25 | 1.08 | 3800972015722 |
| 511419 | 32 | 1.08 | 3800972015739 |

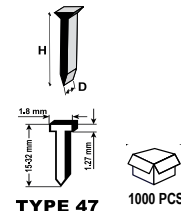

CORDLESS SPRAY GUN SOLO RDP-SSGC20

• [BG] Пистолет за боя без батерия и зарядно • [RO] Pistol de pulverizare fără acumulator și încărcător • [SR] Akumulatorski pištolj za prskanje bez baterija i punjač • [MK] Безжичен пиштол без батерија и полнач • [RU] Аккумуляторный пистолет без аккумулятора и зарядного устройства • [SL] Akumulatorska brizgalna pištola brez baterije in polnilnika • [EL] Ακουστικό ψεκαστήρα χωρίς μπαταρία και φορτιστή • [HR] Akumulatorski pištolj za prskanje bez baterije i punjača • [FR] Pistolet sans fil sans batterie et chargeur • [IT] Pistola a batteria senza batteria e caricatore • [ES] Śnurfunda pistolo sen baterio kaj senšargilo • [PT] Pistolet sans fil sans batterie et chargeur

NEW PRODUCT

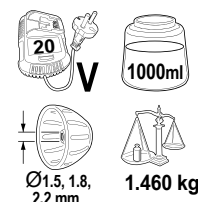

NOZZLES & FILTERS SET FOR CORDLESS SPRAY GUN RDP-SSGC20



CONTAINER CAPACITY
1000 ml

DUSE DIAMETER
Ø 1.5, 1.8, 2.2 mm

RDP-SSGC20 SOLO

| Art.No | gross weight | in carton | barcode |
|--------|--------------|-----------|---------------|
| 074202 | 1.620 kg | 4 | 3800972014770 |

NOZZLES AND FILTERS FOR RDP-SSGC20

| Art.No | gross weight | in carton | barcode |
|--------|--------------|-----------|---------------|
| 110914 | 0.070 kg | 300 | 3800972015906 |

BRUSHLESS CORDLESS BRUSH CUTTER WITH BLADE AND TRIMMER HEAD DETACHABLE SHAFT RDP-SBBC20 SET

- [BG] Коса акумулаторна безщеткова с нож и корда сгъваема • [RO] Cuțit fără perii cu lamă și cap de tuns • [SR] Akumulatorski bežičen sekač so sečiloto i glava • [MK] Безжичен секач со сечилото и глава
- [RU] Аккумуляторный кусторез с лезвием и триммерной головкой • [SL] Akumulatorski rezalnik ščetk z rezilom in glavo trimera • [EL] Επαναφορτιζόμενη βούρτσα με λεπίδα και κεφαλή κοπής
- [HR] Akumulatorski rezač četka s oštricom i trimer glavom • [FR] Débroussailleuse sans fil avec lame et tête de coupe
- [IT] Decespugliatore a batteria con lama e testa di rifinitura • [ES] Senfunda trançila brotilo kun klingo kaj tondanta kapo
- [PT] Roçadeira sem fio com lâmina e cabeça de corte

**NEW
PRODUCT**



BRUSHLESS



**CUTTING
DIAMETER
WITH CORD
300 mm**



**CUTTING
DIAMETER
WITH BLADE
255 mm**

RDP-SBBC20 WITH 1 BATTERY 2Ah SET

| Art.No | barcode |
|--------|---------------|
| 075711 | 3800972016668 |

POLE SAW HEAD WITH TUBE FOR RDP-SBBC20

- [BG] Кастрачка • [RO] Capul de ferăstrău pol cu tub • [SR] Polna testera • [MK] Полјакот виде глава • [RU] Полюс увидел голову с трубкой • [SL] Glava žaga s cevjo • [EL] Ο πόλος είδε το κεφάλι με σωλήνα • [HR] Poljak vidio žaga s cevjo • [FR] Scie à perche • [IT] Palo vide • [ES] Poluso vidis • [PT] Serra de poste

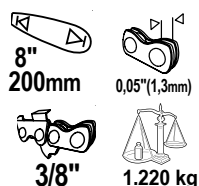

| Art.No | barcode |
|--------|---------------|
| 075712 | 3800972016675 |

HEDGE TRIMMER HEAD WITH TUBE FOR RDP-SBBC20

- [BG] Резачка за храсти • [RO] Cap de tuns cu balamuc cu tub • [SR] Glava trimera za živice sa cevkom • [MK] Тример за сечење на храст • [RU] Головка триммера за živice • [SL] Glava škarje za živo mejo • [EL] Κεφαλή κοπής φρακτών • [HR] Glava trimera za živicu • [FR] Tête de taille-haie • [IT] Testa del tagliasiepi • [ES] Tondilo de hego • [PT] Aparador de cerca viva

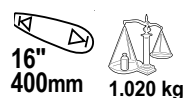

| Art.No | barcode |
|--------|---------------|
| 075713 | 3800972016682 |



CORDLESS BRUSH CUTTER SOLO RDP-SCBC20

- [BG] Коса акумулаторна без батерия и зарядно • [RO] Cuțit pentru tăietori fără perii fără baterie și încărcător
- [SR] Akumulatorski rezač četki bez baterije i punjača • [MK] Безжичен трева машина без батерија и полнач
- [RU] Аккумуляторная косилка без аккумулятора и зарядного устройства • [SL] Akumulatorska kosilka brez baterije in polnilnika • [EL] Χλοοκοπτικό χωρίς μπαταρία και φορτιστή • [HR] Akumulatorske kosilice bez baterije i punjača
- [FR] Tondeuse à gazon sans batterie et chargeur • [IT] Tosaerba senza batteria e caricabatterie • [ES] Gazontondilo sin batería y cargador • [PT] Corta relvas sem bateria e carregador

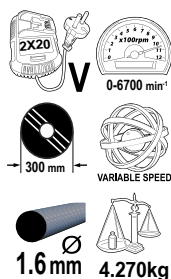

**CUTTING
DIAMETER
WITH CORD
300 mm**

RDP-SCBC20 SOLO

| Art.No | gross weight | in carton | barcode |
|--------|--------------|-----------|---------------|
| 075545 | 4.750 kg | 2 pcs | 3800972014671 |

CORDLESS LAWN MOWER SOLO RDP-SLM20

• [BG] Акумулаторна косачка без батерия и зарядно • [RO] Mașină de tuns iarba fără baterie și încărcător • [SR] Kosiilica za travu bez baterije i punjača • [MK] Батериска косилка за трева без батерија и полнач • [RU] Акумулаторная косилка без аккумулятора и зарядного устройства • [SL] Akumulatorska kosilka brez baterije in polnilnika • [EL] Χλοοκοπτικό χωρίς μπαταρία και φορτιστή • [HR] Akumulatorske kosilice bez baterije i punjača • [FR] Tondeuse à gazon sans batterie et chargeur • [IT] Tosaerba senza batteria e caricabatterie • [ES] Gazontondilo sin batería y cargador • [PT] Corta relvas sem bateria e carregador

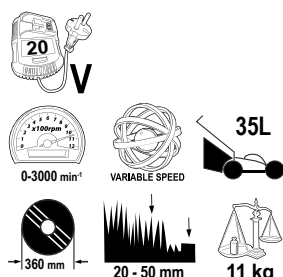

RDP-SLM20 SOLO

| Art.No | gross weight | in cartoon | barcode |
|--------|--------------|------------|---------------|
| 075328 | 12.500 kg | | 3800972009448 |

FOR RDP-SLM20 SOLO

| Art.No | gross weight | in cartoon | barcode |
|--------|--------------|------------|---------------|
| 110278 | 0.500 kg | | 3800972010451 |



CORDLESS HEDGE TRIMMER SOLO RDP-SCHT20

• [BG] Резачка за храсти без батерия и зарядно • [RO] Trimmer pt. gard fără baterie și încărcător • [SR] Bežični trimer za živu ogradu bez baterija i punjača • [MK] Бежичен тример со жива хец без батерија и полнач • [RU] Акумулаторный кусторез без аккумулятора и зарядного устройства • [SL] Akumulatorski škarje za živo mejo brez baterije in polnilnika • [EL] Ασύρματο φτερό φρένων μπαταρία και φορτιστή • [HR] Akumulatorski trimer za živu ogradu bez baterije i punjača • [FR] Taille-haie sans fil sans batterie et chargeur • [IT] Tagliasiepi a batteria senza batteria e caricabatterie • [ES] Senkabila heñezezurilo sin batería y cargador • [PT] Corta-sebes sem bateria e carregador

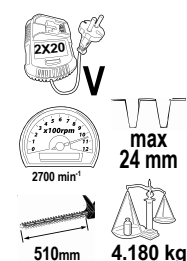

RDP-SCHT20 SOLO

| Art.No | gross weight | in cartoon | barcode |
|--------|--------------|------------|---------------|
| 075707 | 4.650 kg | 2 pcs | 3800972014688 |

CORDLESS BRUSHLESS PRUNING SHEARS SOLO RDP-PSH01

• [BG] Ножица лозарска акум. безчеткова • [RO] Foarfeca de gradina • [SR] Makaze voćarske • [MK] Градинарски ножици • [RU] Садовые ножницы • [SL] Vrtnе škarje • [EL] Ψαλίδι κλαδέματος • [HR] Makaze • [FR] Cisailles d'égagage • [IT] Cesoie • [ES] • [PT] Tesoura de jardim

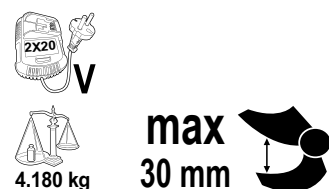
BRUSHLESS

| Art.No | gross weight | in cartoon | barcode |
|--------|--------------|------------|---------------|
| 075714 | 4.650 kg | 2 pcs | 3800972016699 |

CORDLESS POLE SAW RDP-SPS20 SET

• [BG] Кастрачка акумулаторна • [RO] Fierăstrău de stâlp fără fir • [SR] Akumulatorska polovna testera • [MK] Бежичена тестера • [RU] Аккумуляторный кусторез • [SL] Akumulatorski škarje
• [EL] Ασύρματο πριόνι • [HR] Akumulatorska pila • [FR] Scie à perche sans fil • [IT] Sega polare a batteria • [ES] Senmovva stangeto vidis • [PT] Serra sem fio



RDP-SPS20 WITH 1 BATTERY 2Ah SET

| Art.No | barcode |
|--------|---------------|
| 075708 | 3800972016637 |

CORDLESS CHAIN SAW WITHOUT BATTERY AND CHARGER RDP-SCHS20

• [BG] Резачка акумулаторна • [RO] Ferăstrăie fără fir • [SR] Akumulatorska motorna testera • [MK] Бежичена тестера • [RU] Аккумуляторная цепная пила • [SL] Brezžična motorna žaga
• [EL] Επαναφορτιζόμενο αλυσοπριόνιο • [HR] Akumulatorska motorna pila • [FR] Scie sans fil • [IT] Sega a batteria • [ES] Sendrata sego • [PT] Serra sem fio

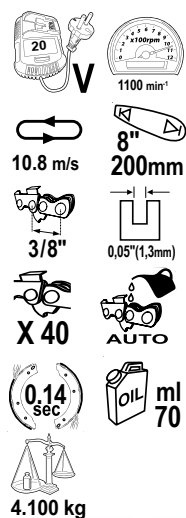

NEW PRODUCT



RDP-SCHS20 SET

+



CHARGING TIME
1 HOUR



ERGONOMIC
HANDLE

OREGON

RDP-SCHS20 SOLO

| Art.No | barcode |
|--------|---------------|
| 075710 | 3800972016651 |

RDP-SCHS20 WITH 1 BATTERIES 3Ah SET

| Art.No | barcode |
|--------|---------------|
| 075709 | 3800972016644 |

CORDLESS CHAIN SAW

BRUSHLESS

RDP-SBCS20



- [BG] Резачка безчеткова акумулаторна без батерия и зарядно
- [RO] Fierăstrău cu lant fara acumulator si incarcator
- [SR] Akumulatorska motorna testera bez baterija i punjač
- [MK] Бежичен моторна пила без батерија и полнач
- [RU] Аккумуляторная цепная пила без аккумулятора и зарядного устройства
- [SL] Brezžična motorna žaga brez baterije in polnilnika
- [EL] Επαναφορτιζόμενο αλυσοπριόνιο χωρίς μπαταρία και φορτιστή
- [HR] Akumulatorska motorna pila bez baterije i punjača
- [FR] Scie à chaîne sans fil sans batterie et chargeur
- [IT] Motosega a batteria senza batteria e caricabatterie
- [ES] Cenvojo sin batería y cargador
- [PT] Motosserra sem bateria e carregador



OREGON

RDP-SBCS20 SOLO

| Art.No | gross weight | in cartoon | barcode |
|--------|--------------|------------|---------------|
| 030155 | 4.800 kg | 2 pcs | 3800972014435 |

WET & DRY VACUUM CLEANER SOLO RDP-SDWC20

- [BG] Прахосмукачка за сухо и мокро • [RO] Aspirator umed/uscat fara acumulator si incarcator
- [SR] Usisivača za mokro i suvo [MK] Правосмукалка за суво и мокро • [RU] Мокрый и сухой пылесос • [SL] Sesalnik za mokro in suho • [EL] Ηλεκτρική σκούπα για υγρά και ξηρά
- [HR] Usisivač za mokre i suhe podloge • [FR] Aspirateur • [IT] Aspirapolvere
- [ES] Polvosuñilo • [PT] Aspirador "WET & DRY"



VACUUM
8 kPa



RDP-SDWC20 SOLO

| Art.No | gross weight | in cartoon | barcode |
|--------|--------------|------------|---------------|
| 090319 | 4.900 kg | 1 | 3800972015883 |

ASH VACUUM CLEANER SOLO RDP-SWC20

- [BG] Прахосмукачка за пепел • [RO] Aspirator pentru cenusa fara acumulator si incarcator
- [SR] Usisivač za pepeo [MK] Правосмукалка за пепел • [RU] Пепла пылесос
- [SL] Sesalnik pepela • [EL] Σκούπα φίλτρο σταχτήσ • [HR] Usisivač za uklanjanje pepela
- [FR] Aspirateur de cendre • [IT] Aspirapolvere per cenere
- [ES] Ash malplena • [PT] Aspirador de cinzas



VACUUM
8 kPa



RDP-SWC20 SOLO

| Art.No | gross weight | in cartoon | barcode |
|--------|--------------|------------|---------------|
| 090315 | 3.500 kg | 1 | 3800972015845 |

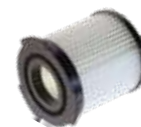

HEPA FILTER

FOR RD-WC06, RDP-SWC20

| Art.No | gross weight | in cartoon | barcode |
|--------|--------------|------------|---------------|
| 090320 | 0.280 kg | 24 pcs | 3800972015890 |



ONE BATTERY
FITS
ALL

SYSTEM STARTER KIT RDP-R20 SYSTEM

- [BG] Комплект батерия и зарядно • [RO] Set acumulator si incarcator • [SR] Set baterija i punjač • [MK] Батерија и полнач сет • [RU] Аккумулятор и зарядное устройство сет
- [SL] Baterija iv polnilec baterij set • [EL] Μπαταρία και φορτιστή σέτ • [HR] Baterije i punjača set • [FR] Batterie et chargeur set • [IT] Batteria e caricabatterie set • [ES] Batería y cargador set
- [PT] Bateria e carregador set



| Art.No | gross weight | in cartoon | barcode |
|--------|--------------|------------|---------------|
| 032120 | 0.980 kg | 4 pcs | 3800123168307 |

BATTERY PACK RDP-R20 SYSTEM

• [BG] Батерия • [RO] Acumulator • [SR] Baterija • [MK] Батерија • [RU] Аккумулятор • [SL] Baterija • [EL] Μπαταρία • [HR] Baterija • [FR] Batterie • [IT] Batteria • [ES] Bateria • [PT] Bateria



| Art.No | V | Ah | net weightkg | gross weight | in cartoon | barcode |
|--------|----|-----|--------------|--------------|------------|---------------|
| 131110 | 20 | 1.5 | 0.400 | 0.550 | 10 pcs | 3800123168284 |
| 131152 | 20 | 2 | 0.700 | 0.860 | 10 pcs | 3800972005310 |
| 131159 | 20 | 3 | 0.730 | 0.800 | 10 pcs | 3800972017245 |
| 131153 | 20 | 4 | 0.760 | 0.850 | 10 pcs | 3800972005327 |



| Art.No | V | Ah | net weightkg | gross weight | in cartoon | barcode |
|--------|----|----|--------------|--------------|------------|---------------|
| 131161 | 20 | 6 | 0.900 | 0.960 | 10 pcs | 3800972014718 |



CHARGER RDP-R20 SYSTEM

• [BG] Зарядно • [RO] Incarcator • [SR] Punjač • [MK] Полнач на батерии • [RU] Зарядное устройство • [SL] Polnilec baterij • [EL] Φορτιστής μπαταρίας • [HR] Punjač baterije • [FR] Chargeur de batterie • [IT] Caricabatterie • [ES] Cargador de batería • [PT] Carregador de bateria



| Art.No | Ah | net weightkg | gross weight | in cartoon | barcode |
|---------|-----|--------------|--------------|------------|---------------|
| 039703 | 2.4 | 0.450 | 0.500 | 10 pcs | 3800123168291 |
| 039704* | 3.5 | 0.500 | 0.550 | 10 pcs | 3800972005334 |

* [BG] Бързо зарядно • [RO] Incarcator rapid • [SR] Brzi punjač • [MK] Брз полнач на батерии • [RU] Быстрое зарядное устройство • [SL] Hiter polnillec baterij • [EL] Γρήγορο φορτιστή μπαταρίας • [HR] Brzo punjač baterije • [FR] Chargeur rapide de batterie • [IT] Caricatore rapido • [ES] Cargador rápido de batería • [PT] Carregador rápido de bateria

DUAL CHARGER RDP-R20 SYSTEM

• [BG] Зарядно двойно • [RO] Incarcator dual • [SR] Dvojni punjač • [MK] Двоен полнач на батерии • [RU] Двойное зарядное устройство • [SL] Dvojni polnilnik • [EL] Διπλό φορτιστή • [HR] Dvostruki punjač • [FR] Double chargeur • [IT] Caricatore doppio • [ES] Duobla šargilo • [PT] Carregador duplo

2x3A

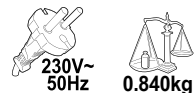

| Art.No | net weightkg | gross weight | in cartoon | barcode |
|--------|--------------|--------------|------------|---------------|
| 039707 | 0.900 | 0.940 | 10 pcs | 3800972014459 |



ADAPTER USB WITH LAMP FOR SERIES R20 SOLO

• [BG] Адаптор USB с лампа • [RO] Adaptor USB • [SR] Adapter USB sa lampom • [MK] Адаптер USB со светилка • [RU] Адаптер USB с лампой • [SL] Adapter USB z žarnico • [EL] Προσαρμογέας USB με λάμπα • [HR] USB adapter s lampom • [FR] Adaptateur USB avec lampe • [IT] Adattatore USB con lampada • [ES] Adaptilo USB kun lampo • [PT] Adaptador USB com lâmpada

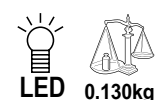

| Art.No | net weightkg | gross weight | in cartoon | barcode |
|--------|--------------|--------------|------------|---------------|
| 039706 | 0.130 | 0.150 | 50 pcs | 3800972014442 |



CORDLESS DRILL

- [BG] Акумулаторна бормашина • [RO] Masina de gaurit si insurubat
- [SR] Bušilica • [MK] Батериска бормашина • [RU] Аккумуляторная дрель
- [SL] Akumulatorski vrtalnik vijasnik • [EL] Δραπανοκατασφίδο
- [HR] Akumulatorska bušilica • [FR] Perceuse sans fil
- [IT] Trapano senza cordone • [ES] Taladro inalambrico sin batería y cargado
- [PT] Aparafusadora



RDP-CDL30

12V

1.5 Ah



• Art.No 030214

• Barcode: 3800972016491

IMPACT DRILL

- [BG] Бормашина • [RO] Bormasina • [SR] Bušilica • [MK] Бормашина
- [RU] Дрель • [SL] Vrtalnik • [EL] Κρουστικό δραπανο • [HR] Bušilica
- [FR] Perceuse • [IT] Trapano • [ES] Taladro • [PT] Aparafusado



RDP-ID43
450 W



• Art.No 010202

• Barcode: 3800972015371



RDP-ID42
910 W



• Art.No 010201

• Barcode: 3800972015364

BLACK
EDITION

ANGLE GRINDER

- [BG] Ъглошлайф • [RO] Polizor unghiular
- [SR] Brusilica ugaoa • [MK] Брусилка
- [RU] Угловая шлифовальная машина • [SL] Kotni brusilnik
- [EL] Κρουστικό δραπετο • [HR] Kutna brusilica • [FR] Meuleuse à angle
- [IT] Smerigliatrice angolare • [ES] Angulo muelilo • [PT] Rebarbadora



- Art.No 020143
- Barcode: 3800123166839



- Art.No 020144
- Barcode: 3800123166822

R20 SYSTEM

PRO & POWER TOOLS

PNEUMATICS

ACCESSORIES



230V-
50Hz



750 W 11000 min⁻¹



22.2 mm 125 mm



1.680 KG

RDP-AG42
750 W



230V-
50Hz



910 W 8000 min⁻¹
12000



22.2 mm 125 mm



2.000 KG

RDP-AG43
910 W



RDP-AG62
900 W



- Art.No 020302
- Barcode: 3800972015128



RDP-AG63
1200 W



- Art.No 020303
- Barcode: 3800972015135



RDP-AG64
1500 W



- Art.No 020304
- Barcode: 3800972015142



RDP-AG65
2400 W



- Art.No 020401
- Barcode: 3800972015159

RAIDER®



CORDLESS SCREWDRIVER

• [BG] Отвертка акумулаторна • [RO] Surubelnita cu acumulator • [SR] Akumulatorski odvrtac • [MK] Акумулаторски одвртувач • [RU] Аккумуляторная отвертка • [SL] Akumulatorski vijacnik • [EL] Κατσαβίδι μπαταρίας • [HR] Akumulatorski odvijač • [FR] Tournevis sans fil • [IT] Cacciavite a batteria • [ES] Senkabila śraūbilo • [PT] Aparafusadora

RD-CSCLO4

3.6 V **LITHIUM-ION**

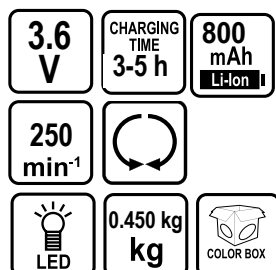

| Art.No | gross weight | in cartoon | barcode |
|--------|--------------|------------|---------------|
| 031201 | 0.500 kg | 20 pcs | 3800972001558 |

RDP-CSCLO1

3.6 V **LITHIUM-ION**

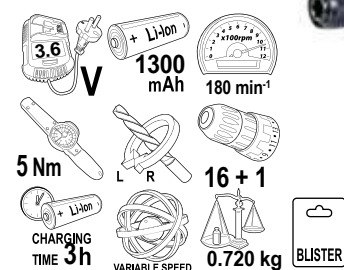

| Art.No | gross weight | in cartoon | barcode |
|--------|--------------|------------|---------------|
| 031106 | 0.800 kg | 10 pcs | 3800123162305 |

RDP-CSCLO3

3.6 V **LITHIUM-ION**

- ALUMINIUM CASE
- 1pcs 25mm AD holder
- 1pcs 50mm AD holder
- 1pc magnetic bit holder 60mm
- 99PCS 25mm screwdriver bits(material: carbon steel)

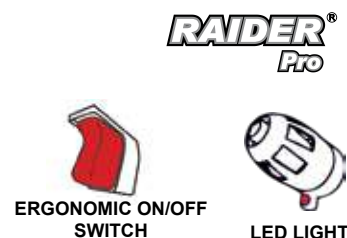
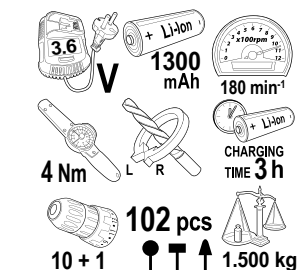

| Art.No | gross weight | in cartoon | barcode |
|--------|--------------|------------|---------------|
| 031128 | 1.670 kg | 10 pcs | 3800123169526 |

REVOLVER CORDLESS SCREWDRIVER RDP-CSCLO2

• [BG] Отвертка акумулаторна револверна • [RO] Surubelnita cu acumulator • [SR] Akumulatorski odvrtac • [MK] Акумулаторски одвртувач • [RU] Аккумуляторная отвертка • [SL] Akumulatorski vijacnik • [EL] Κατσαβίδι μπαταρίας • [HR] Akumulatorski odvijač • [FR] Tournevis sans fil revolver • [IT] Giravite a batteria revolver • [ES] Ruliği senkablān śraūbkanilon • [PT] Aparafusadora

3.6 V **LITHIUM-ION**

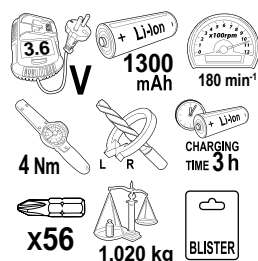

| Art.No | gross weight | in cartoon | barcode |
|--------|--------------|------------|---------------|
| 031107 | 1.130 kg | 6 pcs | 3800123166150 |

CORDLESS DRILL

• [BG] Акумулаторна бормашина • [RO] Bormașină cu acumulator • [SR] Bušilica sa akumulatorom • [MK] Батериска бормашина • [RU] Аккумуляторная дрель
 • [SL] Akumulatorski vrtnalnik vijasnik • [EL] Τρυπάνι Μ Συσσωρυτή • [HR] Akumulatorska bušilica • [FR] Perceuse sans fil avec batterie et chargeur
 • [IT] Trapano senza cordone con batteria e caricabatterie • [ES] Taladro inalámbrico con batería y cargador • [PT] Aparafusadora

RDP-CDL03L RAIDER[®] Pro

12 V LITHIUM-ION

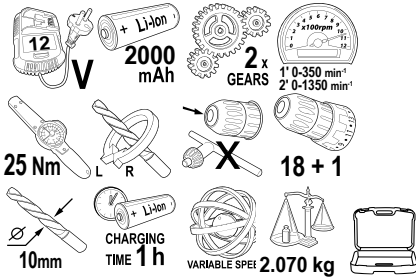

| Art.No | gross weight | in cartoon | barcode |
|--------|--------------|------------|---------------|
| 030118 | 2.300 kg | 5 pcs | 3800123162312 |



LED CORDLESS WORKING LIGHT RDP-CDL03L



| Art.No | gross weight | in cartoon | barcode |
|--------|--------------|------------|---------------|
| 039913 | 0.100 | 50 pcs | 3800123167041 |

BATTERY FOR CORDLESS DRILL LI-ION

| art. № | V | Ah | barcode |
|--------|----|----|---------------|
| 131132 | 12 | 2 | 3800123167072 |

CHARGER FOR CORDLESS DRILL LI-ION

| art. № | V | charge time | barcode |
|--------|-----|-------------|---------------|
| 032110 | 230 | 1 h | 3800123167140 |

RDP-CDL08L RAIDER[®] Pro

12 V LITHIUM-ION

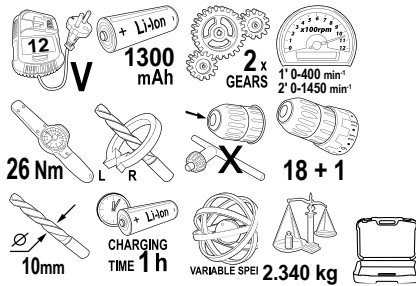

| Art.No | gross weight | in cartoon | barcode |
|--------|--------------|------------|---------------|
| 030123 | 2.600 kg | 5 pcs | 3800123167058 |



BATTERY FOR CORDLESS DRILL LI-ION

| art. № | V | Ah | barcode |
|--------|----|----|---------------|
| 131133 | 12 | 2 | 3800123167089 |

CHARGER FOR CORDLESS DRILL LI-ION

| art. № | V | charge time | barcode |
|--------|-----|-------------|---------------|
| 032111 | 230 | 1 h | 3800123167157 |

RDP-CDL21 RAIDER[®] Pro

20 V LITHIUM-ION

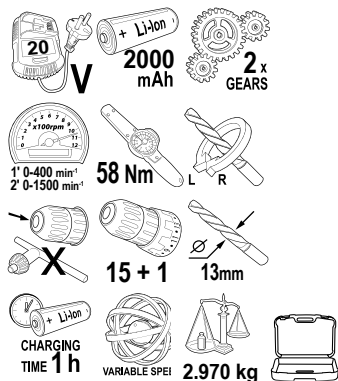

| Art.No | gross weight | in cartoon | barcode |
|--------|--------------|------------|---------------|
| 030207 | 3.300 kg | 5 pcs | 3800972004764 |



2 BATTERIES



BATTERY FOR CORDLESS DRILL LI-ION

| art. № | V | Ah | barcode |
|--------|----|----|---------------|
| 131151 | 20 | 2 | 3800972005082 |

CHARGER FOR CORDLESS DRILL LI-ION

| art. № | V | barcode |
|--------|-----|---------------|
| 039702 | 230 | 3800972004818 |

ECCENTRIC ADAPTOR QUICK CHANGE FOR RDP-CDL21

Art. N 139007
EAN: 3800972015173



ANGLE ADAPTOR QUICK CHANGE FOR RDP-CDL21

Art. N 139005
EAN: 3800972014568



DRILL CHUCK FOR RDP-CDL21

Art. N 139006
EAN: 3800972014572



ACCESSORIES RAIDER MACHINES R20 SYSTEM PNEUMATICS

CORDLESS DRILL

• [BG] Акумулаторна бормашина • [RO] Bormașină cu acumulator • [SR] Bušilica sa akumulatorom • [MK] Батериска бормашина • [RU] Аккумуляторная дрель • [SL] Akumulatorski vrtnalnik vijajnik
 • [EL] Τρυπάνων Μ Συσσωρευτή • [HR] Akumulatorska bušilica • [FR] Perceuse sans fil avec batterie et chargeur • [IT] Trapano senza cordone con batteria e caricabatterie • [ES] Taladro inalámbrico con batería y cargador • [PT] Aparafusadora

RD-CDL27

12 V **LITHIUM-ION**

12 V
1500 mAh
Li-Ion
1' 0-400
2' 0-1400
min⁻¹

28 Nm
0.8-10mm
18+1

2 x GEARS
LED
1.9 kg



ACCESSORIES 13pcs:
 • 6pcs 25mm screwdriver (PH1, PH2, PZ1, PZ2, 5, 6)
 • 6pcs drill (1.5, 2.5, 3, 4, 5, 6)
 • 1pc 60mm bits holder



TWO GEARS ERGONOMIC SOFT HANDLE

| Art.No | gross weight | in carton | barcode |
|--------|--------------|-----------|---------------|
| 030149 | 2.2 kg | 8 pcs | 3800972008946 |

RD-CDL09T

12 V **LITHIUM-ION** **2 BATTERIES**

12 V
1500 mAh
Li-Ion
1' 0-400
2' 0-1400
min⁻¹

28 Nm
0.8-10mm
18+1

2 x GEARS
LED
2 kg



ACCESSORIES 13pcs:
 • 6pcs 25mm screwdriver (PH1, PH2, PZ1, PZ2, 5, 6)
 • 6pcs drill (1.5, 2.5, 3, 4, 5, 6)
 • 1pc 60mm bits holder

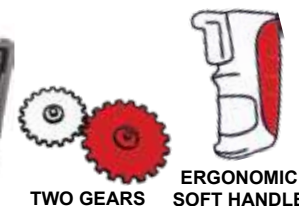

TWO GEARS ERGONOMIC SOFT HANDLE

| Art.No | gross weight | in carton | barcode |
|--------|--------------|-----------|---------------|
| 030125 | 2.240 kg | 8 pcs | 3800123167324 |

RD-CDL26

12 V **LITHIUM-ION** **2 BATTERIES**

12 V
1500 mAh
Li-Ion
1' 0-400
2' 0-1400
min⁻¹

28 Nm
0.8-10mm
18+1

2 x GEARS
LED
0.9 kg



ACCESSORIES 13pcs:
 • 6pcs 25mm screwdriver (PH1, PH2, PZ1, PZ2, 5, 6)
 • 6pcs drill (1.5, 2.5, 3, 4, 5, 6)
 • 1pc 60mm bits holder

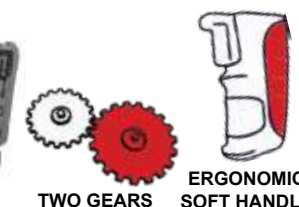

TWO GEARS ERGONOMIC SOFT HANDLE

| Art.No | gross weight | in carton | barcode |
|--------|--------------|-----------|---------------|
| 030148 | 1.1 kg | 8 pcs | 3800872008717 |

RATCHET WRENCH RD-RW01

• [BG] Трещотка акумулаторна в куфар с аксесоари • [RO] Cheie cu clichet • [SR] Račna sa akumulatorom • [MK] Батериска крцкалка • [RU] Аккумуляторная трещотка • [SL] Akumulatorski ratchet pisemo z dodatki • [EL] Μηχανισμός ratchet με αξεσουάρ • [HR] Akumulatorska račna • [FR] Clé à cliquet avec accessoires • [IT] chiave a cricchetto a batteria con accessori • [ES] Wrench kaj accesorios • [PT] Aparafusadora

12 V **LITHIUM-ION**

12 V
CHARGING TIME
1h

2000 mAh
Li-Ion
230 min⁻¹
3/8" inch

40 Nm
0.650 kg



ACCESSORIES 8 pcs:
 Adapter 3/8" F-1/4" M, sockets - 10mm, 11mm, 12mm, 13mm, 14mm, 15mm, 17mm.

NEW PRODUCT

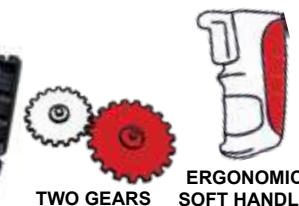

TWO GEARS ERGONOMIC SOFT HANDLE

| Art.No | gross weight | in carton | barcode |
|--------|--------------|-----------|---------------|
| 030150 | 0.830 kg | 8 pcs | 3800972008975 |

RECIPROCATING SAW RD-RS31

• [BG] Трион саблвиден акумулаторен • [RO] Fierastrau sabie cu acumulator • [SR] Жилпа Testera • [MK] Батериска Враќање пила • [RU] Акумуляторная сабельная пила • [SL] Vretena žagai • [EL] Παλινδρομικό πριόνι • [HR] Povratna pila • [FR] Scie alternative • [IT] Sega a batteria con accessori • [ES] Reciproca seruro • [PT] Serra de vaivém

12 V

LITHIUM-ION

NEW PRODUCT

12 V

1500 mAh
Li-Ion

0-3000 min⁻¹

6 mm

20mm AL

100 mm

0.650 kg



FOR WOOD



FOR METAL

| Art.No | barcode |
|--------|---------------|
| 050130 | 3800972015272 |

FOR MODELS:

- RD-CDL09T
- RD-CDL26
- RD-CDL27
- RD-RW01



BATTERY LI-ION

| art. № | V | Ah | barcode |
|--------|----|-----|---------------|
| 131154 | 12 | 1,5 | 3800972008755 |
| 131155 | 12 | 2 | 3800972009899 |



CHARGER

| art. № | V | barcode |
|--------|-----|---------------|
| 039705 | 230 | 3800972008748 |

RD-CDL33

NEW PRODUCT

12 V

LITHIUM-ION

12 V

1500 mAh
Li-Ion

1' 0-400
2' 0-1400
min⁻¹

24 Nm

0.8-10mm

18 + 1

2 x GEARS

LED

1.1 kg

COLOR BOX



TWO GEARS ERGONOMIC SOFT HANDLE

| Art.No | gross weight | in carton | barcode |
|--------|--------------|-----------|---------------|
| 030161 | 1.2 kg | 8 pcs | 3800972019713 |

CHARGER LI-ION

| Art.No | barcode |
|--------|---------------|
| 032125 | 3800972004740 |

BATTERY LI-ION

| Art.No | barcode |
|--------|---------------|
| 131148 | 3800972004726 |

SET CORDLESS DRILL AND HEX IMPACT DRIVER RD-CDIDLO1

• [BG] Комплект акумулаторни бормашина и ударен винтоверт • [RO] Kit de foraj fără fir și șurubelniță cu impact • [SR] Akumulatorska bušilica i udarni odvijač • [MK] Комплет за вежбање без кабел и шрафцигер со удари • [RU] Акумуляторный дрель и ударная отвертка • [SL] Akumulatorski komplet vrtalnika in udarni izvijač • [EL] Ακουστικό kit και κατσαβίδι • [HR] Kit bežičnih bušilica i udarni odvijač • [FR] Kit de perceuse sans fil et tournevis à percussion • [IT] Kit trapano avvitatore a batteria e cacciavite a percussione • [ES] Sendrata Krancilo kaj Erika Šraubturnilo • [PT] Kit de furadeira sem fio e chave de fenda de impacto

12 V

16 + 1

NEW PRODUCT

1' 0-400
2' 0-1450
min⁻¹

LED

12 V LITHIUM-ION

1500 mAh
Li-Ion

28 Nm

0.8-10mm

1.240 kg

CHARGING TIME
3h

2 x GEARS

| Art.No | gross weight | in carton | barcode |
|--------|--------------|-----------|---------------|
| 030158 | 1.580 | 5 | 3800972016507 |



12 V 0-2500 min⁻¹

90 Nm LED

1500 mAh
Li-Ion

METAL GEAR BOX

CHARGING TIME
3h 1.100 kg

min⁻¹

BATTERY LI-ION

| Art.No | barcode |
|--------|---------------|
| 131160 | 3800972019430 |

CHARGER LI-ION

| Art.No | barcode |
|--------|---------------|
| 032131 | 3800972019447 |

RD-CDL15

12V LITHIUM-ION

NEW PRODUCT

| | | |
|---|-------------------------|------------------------|
| 12 V | CHARGING TIME 3h | 1300 mAh Li-Ion |
| 1' 0-400 min⁻¹ 2' 0-1450 min⁻¹ | 24 Nm | 10mm |
| 16+1 | 2 x GEARS | |
| LED | 1.6 kg | |



ACCESSORIES 13 pcs:
 • 6pcs 25mm screwdriver (PH1, PH2, PZ1, PZ2, 5, 6)
 • 6pcs drill (1.5, 2.5, 3, 4, 5, 6)
 • 1pc 60mm bits holder



| Art.No | gross weight | in carton | barcode |
|--------|--------------|-----------|---------------|
| 030203 | 1.800 | 5 | 3800123173981 |

BATTERY LI-ION

| Art.No | gross weight | in carton | barcode |
|--------|--------------|-----------|---------------|
| 131142 | 0.260 | 5 | 3800123173998 |

CHARGER FOR CORDLESS DRILL LI-ION

| Art.No | in carton | barcode |
|--------|-----------|---------------|
| 030203 | 5 | 3800123173981 |

CORDLESS DRILL RDP-CDL28

• [BG] Акумулаторна бормашина • [RO] Bormașină cu acumulator • [SR] Bușiiică sa akumulatorom • [MK] Батериска бормашина • [RU] Аккумуляторная дрель • [SL] Akumulatorski vrtalnik vijacnik • [EL] Τρυπάνω Μ Συσσωρευτή • [HR] Akumulatorska bušiiica • [FR] Perceuse sans fil avec batterie et chargeur • [IT] Trapano senza cordone con batteria e caricabatterie • [ES] Taladro inalámbrico con batería y cargador • [PT] Aparafusadora

18V LITHIUM-ION
2 BATTERIES

NEW PRODUCT

RAIDER Pro

ACCESSORIES 8 pcs:
 Adapter 3/8" F-1/4" M, sockets - 10mm, 11mm, 12mm, 13mm, 14mm, 15mm, 17mm.



ERGONOMIC SOFT HANDLE
TWO GEARS

| Art.No | gross weight | in carton | barcode |
|--------|--------------|-----------|---------------|
| 030156 | 2.3 kg | 8 pcs | 3800972014534 |

BATTERY LI-ION

| art. № | V | Ah | BARCODE |
|--------|----|-----|---------------|
| 131156 | 18 | 1,5 | 3800972014541 |

CHARGER FOR CORDLESS DRILL LI-ION

| art. № | V | barcode |
|--------|-----|---------------|
| 039708 | 230 | 3800972014558 |

| | | | |
|--------------|-------------------------|------------------------|---|
| 18 V | CHARGING TIME 3h | 1500 mAh Li-Ion | 1' 0-350 min⁻¹ 2' 0-1250 min⁻¹ |
| 38 Nm | 10mm | 16+1 | 2 x GEARS |
| | LED | 2 kg | |

ADAPTER USB 12-18V

• [BG] Адаптор • [RO] Adaptor • [SR] Adapter • [MK] Адаптер • [RU] Адаптер • [SL] Adapter • [EL] Προσαρμογέας • [HR] Adapter • [FR] Adaptateur • [IT] Adattatore • [ES] Adaptador • [PT] Adaptador

12 - 18V LITHIUM-ION

- ✓ USB port provides 5 V 2.1 A to charge phones, tablets, MP3 players and more
- ✓ Built-in battery level gauge
- ✓ USB port cannot be used to charge battery

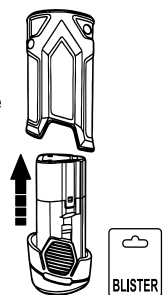

NEW PRODUCT

| Art.No | gross weight | in carton | barcode |
|--------|--------------|-----------|---------------|
| 032129 | 0.120 kg | 40 pcs | 3800972014497 |

CORDLESS DRILL RD-CDL25

• [BG] Акумулаторна бормашина • [RO] Bormașină cu acumulator • [SR] Bušilica sa akumulatomor • [MK] Батериска бормашина • [RU] Акумуляторная дрель • [SL] Akumulatorski vrtalnik vijacnik
• [EL] Τρυπάνω Μ Συσσωρευτή • [HR] Akumulatorska bušilica • [FR] Perceuse sans fil avec batterie et chargeur • [IT] Trapano senza cordone con batteria e caricabatterie • [ES] Taladro inalámbrico con batería y cargador • [PT] Aparafusadora

18 V **LITHIUM-ION**

| | | | |
|----------|---------------------|--------------------|--|
| 18 V | CHARGING TIME 3h | 1500 mAh Li-Ion | 1' 0-350 2' 0-1250 min ⁻¹ |
| 26 Nm | 10mm | 16+1 | |
| 2x GEARS | LED | 1 kg | |



ACCESSORIES 12pcs:
Ø 6 pcs. drills: 1.5 mm; Ø 2.5 mm; Ø 3 mm; Ø 4 mm;
6 pcs. nozzles: 1 flat nozzle 5 mm;
1 flat nozzle 6 mm; 1 nozzle Phillips PH1;
1 nozzle Phillips PH2; 1 nozzle Posidriv P21;
1 nozzle Posidriv P22;



TWO GEARS



ERGONOMIC SOFT HANDLE

| Art.No | gross weight | in cartoon | barcode |
|--------|--------------|------------|---------------|
| 030145 | 1.8 kg | 5 pcs | 3800972005051 |

CORDLESS DRILL RD-CDL29

• [BG] Акумулаторна бормашина • [RO] Bormașină cu acumulator • [SR] Bušilica sa akumulatomor • [MK] Батериска бормашина • [RU] Акумуляторная дрель • [SL] Akumulatorski vrtalnik vijacnik
• [EL] Τρυπάνω Μ Συσσωρευτή • [HR] Akumulatorska bušilica • [FR] Perceuse sans fil avec batterie et chargeur • [IT] Trapano senza cordone con batteria e caricabatterie • [ES] Taladro inalámbrico con batería y cargador • [PT] Aparafusadora

18 V **LITHIUM-ION** **2 BATTERIES**

| | | | |
|--|---------------------|----------|----------------------|
| 18 V | CHARGING TIME 1h | 0.8-10mm | 18+1 |
| 1' 0-400 2' 0-1400 min ⁻¹ | 2x GEARS | 28 Nm | 2x1500 mAh Li-Ion |
| | LED | 1.600 kg | |



TWO GEARS



ERGONOMIC SOFT HANDLE

| Art.No | barcode |
|--------|---------------|
| 030157 | 3800972016484 |

CORDLESS IMPACT WRENCH RD-CIW01

• [BG] Акумулаторен ударен гайковерт • [RO] Pistol de impact • [SR] Zavrtač udarni • [MK] Електронски ударен одвртувач • [RU] Импульсный гайковерт • [SL] Udarni avto vijacnik • [EL] Κρουστικό κλειδί αυτοκίνητου • [HR] Udarni odvijač • [FR] Clé à chocs • [IT] Chiave di impatto • [ES] Llave de impacto eléctrica • [PT] Aparafusadora de impacto

18 V **LITHIUM-ION**

| | | |
|-----------|------------------------|--------------------------|
| 18 V | CHARGING TIME 3h | 0-2750 min ⁻¹ |
| 1/2" inch | 3250 min ⁻¹ | 1500 mAh Li-Ion |
| 350 Nm | LED | 1.100 kg |



METAL GEAR BOX



ERGONOMIC SOFT HANDLE

| Art.No | gross weight | in cartoon | barcode |
|--------|--------------|------------|---------------|
| 030146 | 1.3 | 5 | 3800972005068 |

CORDLESS JIG SAW RD-JSLO1

• [BG] Пробоен трион без батерия и зарядно • [RO] Fierastrau pendular cu acumulator • [SR] Ubodna testera • [MK] Убодна пила • [RU] Маятниковый лобзик • [SL] Nihajna vbodna žaga
• [EL] Παλινδρομική σιγα • [HR] Ubodna pila • [FR] Électrique scie sauteuse • [IT] Sega • [ES] Elektra puzla • [PT] Tico-tico

18 V SOLO LITHIUM-ION

| | |
|-------------------------------|-----------|
| 0-2700 min ⁻¹ | 80 mm |
| 5 mm | 45° |
| DUST CAPTURE ПРАХО-УЛАВЛЯЕ | 1.8 kg |
| | COLOR BOX |

QUICK CHANGE SYSTEM



NEW PRODUCT



TOOLLESS BLADE REPLACEMENT

| | |
|--------|---------------|
| Art.No | barcode |
| 050132 | 3800972016514 |

CORDLESS CIRCULAR SAW RD-CSLO1

• [BG] Циркулар акумулаторен без батерия и зарядно • [RO] Fierastrau circular • [SR] Ručni cirkular • [MK] Циркулар рачен • [RU] Дисковая пила • [SL] Krožna žaga • [EL] Δίσκoσ οτρίοvο • [HR] Ručna kružna pila • [FR] Meuleuse d'angle • [IT] Sega circolar • [ES] Amoladora angular • [PT] Serra circular

18 V SOLO LITHIUM-ION

NEW PRODUCT

| | | |
|---------------------------|----------------------|-----------|
| 4200 min ⁻¹ | ∅ [mm] 150x16x24T | 0-45° |
| 55 mm | 3.020 kg | COLOR BOX |



ADJUSTABLE CUTTING DEPTH

| | | | |
|--------|--------------|------------|---------------|
| Art.No | gross weight | in cartoon | barcode |
| 052112 | 3.350 kg | 8 pcs | 3800972016521 |

CORDLESS RECIPROCATING SAW RD-RSLO1

• [BG] Трион саблевиден акумулаторен без батерия и зарядно • [RO] Fierastrau sabie cu acumulator • [SR] Sabljasta testera • [MK] Пила сабјарка • [RU] Маятниковый лобзик • [SL] Nihajna vbodna žaga • [EL] Πρίοvο σιγα • [HR] Recipro pila • [FR] Scie à mouvement alternative • [IT] Sega universal • [ES] Sierra de sable • [PT] Serra sabre

18 V SOLO LITHIUM-ION

NEW PRODUCT

| | | |
|-------------------------------|--------|----------|
| 0 - 2700 min ⁻¹ | 6 mm | |
| 22mm AL | 100 mm | 2.180 kg |



TOOLLESS BLADE REPLACEMENT



ERGONOMIC SOFT HANDLE



VARIABLE SPEED

| | |
|--------|---------------|
| Art.No | barcode |
| 050133 | 3800972016538 |

BATTERY FOR CORDLESS MACHINES LI-ION

• [BG] Батерия за акумулаторни машини Li-ion • [RO] Acumulator • [SR] Baterija rezervna Li-ion • [MK] Батерија Li-ion • [RU] Аккумулятор Li-ion
• [SL] Baterija Li-ion • [EL] Μπαταρία Li-ion για Δραπανοκατσαβίδο • [HR] Li-ion akumulator • [FR] Batterie pour perceuse sans fil Li-ion • [IT] Batteria per batteria Li-ion • [ES] Kuinilaro por Li-ion • [PT] Bateria para Li-ion

FOR MODELS: ● RD-6TL22 ● RD-HTL04 ● RD-CBL04 ● RD-CDL25

| art. № | V | Ah | BARCODE |
|--------|----|-----|---------------|
| 131143 | 18 | 1,5 | 3800123174339 |



COLOR BOX

| art. № | V | Ah | BARCODE |
|--------|----|----|---------------|
| 131157 | 18 | 2 | 3800972016545 |



COLOR BOX

| art. № | V | Ah | BARCODE |
|--------|----|----|---------------|
| 131158 | 18 | 4 | 3800972016552 |



COLOR BOX

SYSTEM STARTER KIT FOR CORDLESS MACHINES LI-ION

- [BG] Комплект батерия и зарядно • [RO] Kit de pornire a sistemului pentru mașini fără fir • [SR] Sistemski starter set za bežične mašine • [MK] Систем за стартување систем за безжични машини
- [RU] Системный стартовый комплект для беспроводных машин • [SL] Sistemski zaganjalni komplet za brezžične stroje • [EL] σύστημα εκκίνησης συστήματος για ασύρματα μηχανήματα
- [HR] sistemski startni komplet za bežične strojeve • [FR] Kit de démarrage système pour machines sans fil • [IT] Starter kit di sistema per macchine a batteria • [ES] Sistema startigilo por sendrataj maŝinoj
- [PT] Kit inicial do sistema para máquinas sem fio



LITHIUM-ION
BATTERY

**NEW
PRODUCT**



| Art.No | V | Ah | barcode |
|--------|----|----|---------------|
| 032130 | 18 | 2 | 3800972016569 |

CHARGER FOR CORDLESS MACHINES LI-ION

- [BG] Зарядно за акумулаторна бормашина Li-ion • [RO] Incarcator acumulator Li-ion • [SR] Punjač baterije Li-ion • [MK] Полнач за батерија [RU] Зарядное устройство для аккумуляторной дрели Li-ion
- [SL] Polnilec baterij Li-ion • [EL] Φορτιστής μπαταρίας Li-ion • [HR] Punjač za akumulatorske bušilice Li-ion • [FR] Chargeur pour perceuse rechargeable • [IT] Caricatore per trapano ricaricabile • [ES] Cargilo por reŝargebla drilo • [PT] Carregador para furadeira sem fio

| Art.No | for model | V | barcode |
|--------|------------------------------|-----|---------------|
| 032122 | RD-GTL22, RD-HTL04, RD-CBL04 | 230 | 3800123174346 |

18 V

LITHIUM-ION

3 - 5 h



RAPID CHARGER FOR CORDLESS MACHINES LI-ION

| Art.No | for model | V | barcode |
|--------|------------------------------|-----|---------------|
| 032123 | RD-GTL22, RD-HTL04, RD-CBL04 | 230 | 3800123174377 |

18 V

1 h



GRASS TRIMMER WITH BATTERY AND CHARGER RD-GTL22

• [BG] Косачка-тример с батерия и зарядно • [RO] Trimmer pentru iarba cu acumulator • [SR] Trimer za travu sa baterijom i punjačem • [MK] Косилка за трава са батеријом и пуњаčem • [RU] Триммер для травы с аккумулятором и зарядным устройством • [SL] Obrezovalnik trave z baterijo in polnilnikom • [EL] Ηλεκτρικό χορτοκοπτικό • [HR] Kosilica za travu s baterijom i punjačem • [FR] Tondeuse à gazon avec batterie et chargeur • [IT] Taglia erba con batteria e caricabatterie • [ES] Herbo tondilo kun baterio kaj šargilo • [PT] Aparador de grama com bateria e carregador

18 V LITHIUM-ION

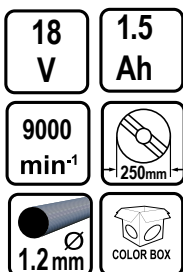

18 V SOLO



| Art.No | gross weight | in cartoon | barcode |
|--|--------------|------------|---------------|
| 075540 Set | 3.730 kg | 2 pcs | 3800972005143 |
| 075528 Solo without battery and charger | 3.500 kg | 2 pcs | 3800123174186 |

CORDLESS HEDGE TRIMMER WITH BATTERY AND CHARGER RD-HTL04

• [BG] Резачка за храсти с батерия и зарядно • [RO] Trimmer pt. gard viu cu acumulator • [SR] Bežični trimer za živu ogradu sa baterijom i punjačem • [MK] Бежичен тример со жива хед са батерија и полнач • [RU] Аккумуляторный кусторез с аккумулятором и зарядным устройством • [SL] Akumulatorski škarije za živo mejo z baterijo in polnilnikom • [EL] Ασύρματο φτερό φρένων με μπαταρία και φορτιστή • [HR] Akumulatorski trimer za živu ogradu s baterijom i punjačem • [FR] Taille-haie sans fil avec batterie et chargeur • [IT] Tagliasiepi a batteria con batteria e caricabatterie • [ES] Senkabila hegelezurilo kun baterio kaj šargilo • [PT] Corta-sebes com bateria e carregador

18 V LITHIUM-ION

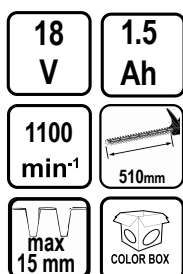

18 V SOLO



| Art.No | gross weight | in cartoon | barcode |
|--|--------------|------------|---------------|
| 075541 Set | 3.550 kg | 2 pcs | 3800972005150 |
| 075704 Solo without battery and charger | 3.300 kg | 2 pcs | 3800123174193 |

CORDLESS BLOWER VACUUM AND SHREDDER WITH BATTERY AND CHARGER RD-CBLO4

• [BG] Уред за обдухване с батерия и зарядно • [RO] Trimmer pt. gard viu cu acumulator • [SR] Usisivač lišća sa baterijom i punjačem • [MK] Всмукувач за лисја со батерија и полнач • [RU] Пылесос для листьев с аккумулятором и зарядным устройством • [SL] Akumulatorski sesalnik za listje • [EL] Μηχανή αναρρόφησης φύλλων • [HR] Akumulatorski usisavač / puhalo lišća • [FR] Aspirateur à feuilles avec batterie et chargeur • [IT] Aspirapolvere a foglia a batteria con batteria e caricabatterie • [ES] Folia polvosučilo kun baterio kaj šargilo • [PT] Soprador com bateria e carregador

18 V LITHIUM-ION

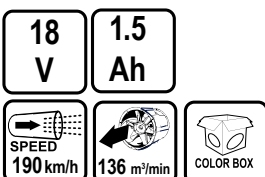

18 V SOLO



| Art.No | gross weight | in cartoon | barcode |
|--|--------------|------------|---------------|
| 075542 Set | 2.800 kg | 2 pcs | 3800972005167 |
| 075530 Solo without battery and charger | 2.290 kg | 2 pcs | 3800123174209 |

ELECTRIC DRILL KEYLESS CHUCK

• [BG] Бормашина • [RO] Bormasina r • [SR] Vušilica • [MK] Бормашина • [RU] Дрель • [SL] Vrtalnik • [EL] Κρουστικό δρᾶπνο • [HR] Vušilica • [FR] Perceuse • [IT] Trapano • [ES] Taladro • [PT] Aparafusadora

RDP-ID32

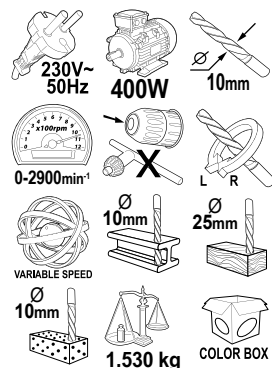

RAIDER
Pro

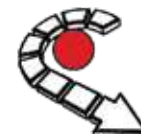

VARIABLE SPEED

| Art.No | gross weight | in cartoon | barcode |
|--------|--------------|------------|---------------|
| 010134 | 1.700 kg | 10 pcs | 3800123165344 |

RDP-ID27



RAIDER
Pro



IMPACT FUNCTION



VARIABLE SPEED

| Art.No | gross weight | in cartoon | barcode |
|--------|--------------|------------|---------------|
| 010129 | 2.200 kg | 10 pcs | 3800123162428 |

RDP-ID28

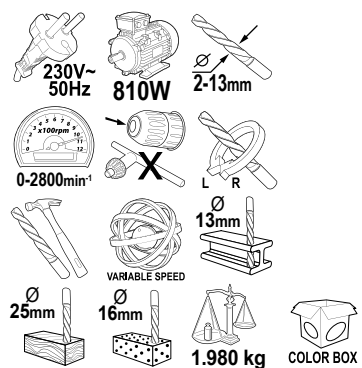

RAIDER
Pro



IMPACT FUNCTION



VARIABLE SPEED

| Art.No | gross weight | in cartoon | barcode |
|--------|--------------|------------|---------------|
| 010130 | 2.200 kg | 10 pcs | 3800123162435 |

ELECTRIC IMPACT DRILL KEYLESS CHUCK

• [BG] Бормашина • [RO] Bormasina • [SR] Bušilica • [MK] Бормашина • [RU] Дрель • [SL] Vrtalnik • [EL] Κρουστικό δρέπανο • [HR] Bušilica • [FR] Perceuse • [IT] Trapano • [ES] Taladro • [PT] Aparafusadora

RDP-ID29

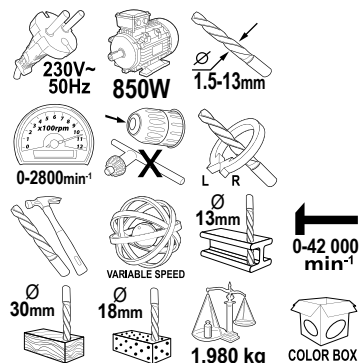

RAIDER®
Pro

**METAL
GEAR BOX**



IMPACT FUNCTION



KEYLESS CHUCK

| Art.No | gross weight | in cartoon | barcode |
|--------|--------------|------------|---------------|
| 010131 | 2.200 kg | 10 pcs | 3800123162442 |

RDP-ID31



RAIDER®
Pro

**METAL
GEAR BOX**



IMPACT FUNCTION



KEYLESS METAL CHUCK

| Art.No | gross weight | in cartoon | barcode |
|--------|--------------|------------|---------------|
| 010133 | 3.700 kg | 5 pcs | 3800123163586 |

ELECTRIC IMPACT DRILL KEYLESS CHUCK

RD-ID40

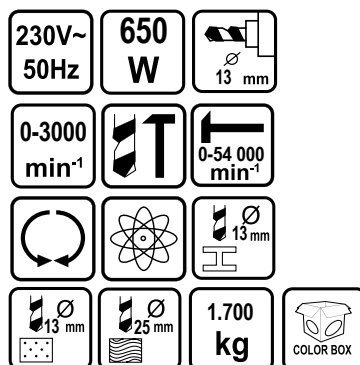

IMPACT FUNCTION



KEYLESS CHUCK

| Art.No | gross weight | in cartoon | barcode |
|--------|--------------|------------|---------------|
| 010140 | 1.9 kg | 10 | 3800972005471 |

ELECTRIC IMPACT DRILL

• [BG] Бормашина • [RO] Bormasina • [SR] Bušilica • [MK] Бормашина • [RU] Дрель • [SL] Vrtnik • [EL] Κρουατίτο βρατάνο • [HR] Bušilica • [FR] Perceuse • [IT] Trapano • [ES] Taladro • [PT] Aparafusadora

RD-ID41

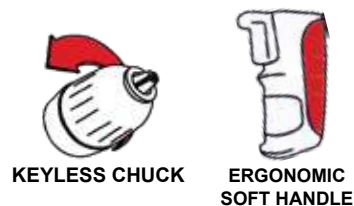
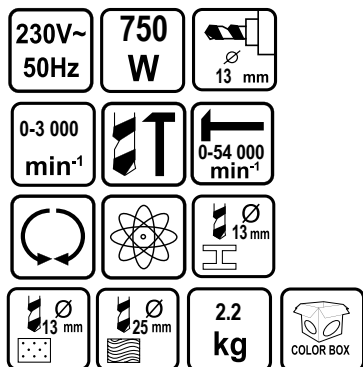

| Art.No | gross weight | in cartoon | barcode |
|--------|--------------|------------|---------------|
| 010141 | 2.4 kg | 10 | 3800972008694 |

RD-ID36

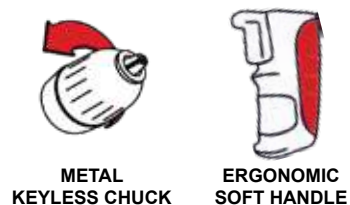
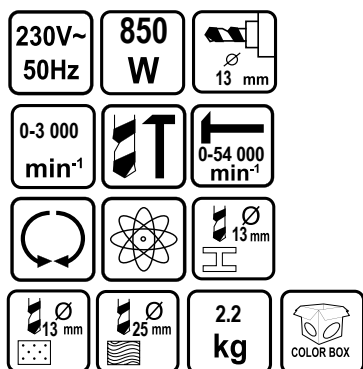

| Art.No | gross weight | in cartoon | barcode |
|--------|--------------|------------|---------------|
| 010139 | 2.4 kg | 10 | 3800972001183 |

RD-ID22



| Art.No | gross weight | in cartoon | barcode |
|--------|--------------|------------|---------------|
| 010119 | 2.7 kg | 10 | 3800123154676 |

RD-ID44

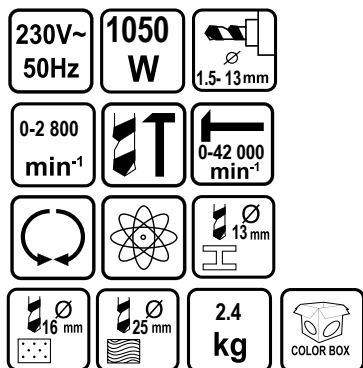

NEW PRODUCT

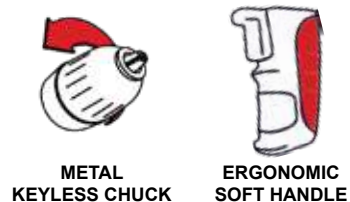

| Art.No | gross weight | in cartoon | barcode |
|--------|--------------|------------|---------------|
| 010142 | 2.7 kg | 10 | 3800972018891 |

ACCESSORIES PNEUMATICS RAIDER MACHINES R20 SYSTEM

BENCH DRILL

• [BG] Настолна бормашина • [RO] Masina de gaurit fixa • [SR] Bušilica stubna • [MK] Бормашина • [RU] Настольно-сверлильный станок [SL] Namizni vrtnali stroj • [EL] Κρουστικό Δράπανο • [HR] Stupna bušilica • [FR] Perceuse d'établi • [IT] Trapano da banco • [ES] Benka trilo • [PT] Berbequim vertical

RDP-BD04

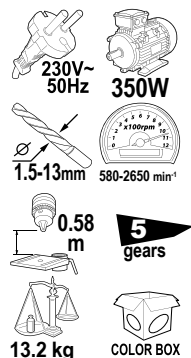

SPINDLE TAPER: B16
SPINDLE SPEED

580 min⁻¹
850 min⁻¹
1220 min⁻¹
1650 min⁻¹
2650 min⁻¹

RAIDER®
Pro



VARIABLE SPEED

| Art.No | gross weight | in cartoon | barcode |
|--------|--------------|------------|---------------|
| 011104 | 14 kg | 1 | 3800123108693 |

RDP-BD05

**NEW
PRODUCT**

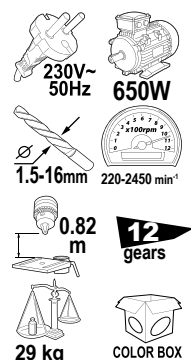

SPINDLE TAPER: B16
SPINDLE SPEED

220 min⁻¹
330 min⁻¹
350 min⁻¹
450 min⁻¹
520 min⁻¹
560 min⁻¹
1050 min⁻¹
1130 min⁻¹
1300 min⁻¹
1630 min⁻¹
1800 min⁻¹
2450 min⁻¹

RAIDER®
Pro



VARIABLE SPEED

| Art.No | gross weight | in cartoon | barcode |
|--------|--------------|------------|---------------|
| 011105 | 31 kg | 1 | 3800972018457 |

RDP-BD02

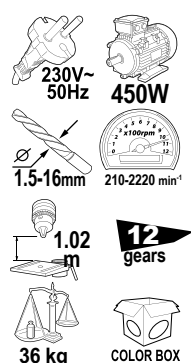

SPINDLE TAPER: MT2
SPINDLE SPEED

210 min⁻¹
300 min⁻¹
350 min⁻¹
450 min⁻¹
500 min⁻¹
540 min⁻¹
970 min⁻¹
1040 min⁻¹
1170 min⁻¹
1480 min⁻¹
1580 min⁻¹
2220 min⁻¹

RAIDER®
Pro

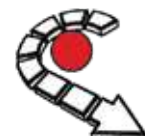

VARIABLE SPEED

| Art.No | gross weight | in cartoon | barcode |
|--------|--------------|------------|---------------|
| 011102 | 38 kg | 1 | 3800123123122 |

RDP-BD03

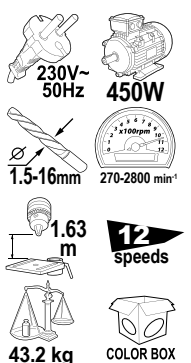

SPINDLE TAPER: B16
SPINDLE SPEED

270 min⁻¹
360 min⁻¹
490 min⁻¹
560 min⁻¹
590 min⁻¹
970 min⁻¹
1100 min⁻¹
1250 min⁻¹
1350 min⁻¹
1620 min⁻¹
2120 min⁻¹
2800 min⁻¹

RAIDER®
Pro



VARIABLE SPEED

| Art.No | gross weight | in cartoon | barcode |
|--------|--------------|------------|---------------|
| 011103 | 48 kg | 1 | 3800123124860 |

DRYWALL SCREWDRIVER

• [BG] Винтоверт • [RO] Surubelnita electrica • [SR] Električni Odvijač • [MK] Штрафилица • [RU] Электрическая отвёртка • [SL] Izvijajč zavijake zagips plošče • [EL] Ηλεκτρικό κατσαβίδι για γυψοσανίδες • [HR] Odvijač • [FR] Tournevis à cloisons sèches • [IT] Cacciavite per cartongesso • [ES] Deseñilo drywall • [PT] Aparafusadora p/ gesso cartonado

RD-CDD07

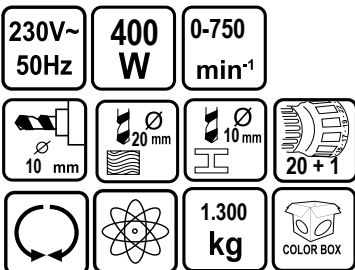

**NEW
PRODUCT**



ERGONOMIC
SOFT HANDLE

| Art.No | barcode |
|--------|---------------|
| 073108 | 3800972016446 |

RD-CDD08

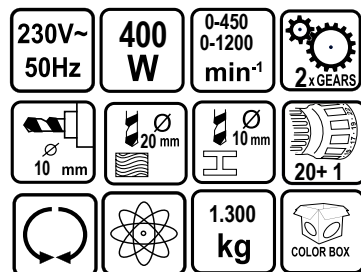

**NEW
PRODUCT**

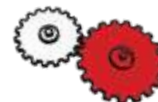

TWO GEARS



ERGONOMIC
SOFT HANDLE

| Art.No | barcode |
|--------|---------------|
| 073109 | 3800972016453 |

RD-CDD04

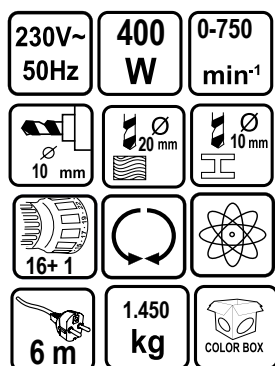

ERGONOMIC ON/OFF
SWITCH

| Art.No | gross weight | in cartoon | barcode |
|--------|--------------|------------|---------------|
| 073105 | 1.650 kg | 10 pcs | 3800972004221 |

RD-CDD03

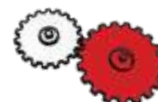

TWO GEARS



ERGONOMIC
SOFT HANDLE

| Art.No | gross weight | in cartoon | barcode |
|--------|--------------|------------|---------------|
| 073104 | 1.700 kg | 5 pcs | 3800123167539 |

DRAYWALL SCREWDRIVER

• [BG] Винтоверт • [RO] Surubelnita electrica • [SR] Električni Odvijač • [MK] Штрафилица • [RU] Электрическая отвёртка • [SL] Izvijač zavijake zagips plošče • [EL] Ηλεκτρικό καταβίδι για γυψοσανίδες
 • [HR] Odvijač • [FR] Tournevis à cloisons sèches • [IT] Cacciavite per cartongesso • [ES] Desegnilo drywall • [PT] Aparafusadora p/ gesso cartonado

RDP-CDD06

NEW PRODUCT



RAIDER® Pro



TWO GEARS



ERGONOMIC SOFT HANDLE

| Art.No | barcode |
|--------|---------------|
| 073301 | 3800972016439 |

RDP-CDD02



RAIDER® Pro



TWO GEARS



ERGONOMIC SOFT HANDLE

| Art.No | gross weight | in cartoon | barcode |
|--------|--------------|------------|---------------|
| 073103 | 3 kg | 5 pcs | 3800123166075 |

DRAYWALL SCREWDRIVER

• [BG] Винтоверт • [RO] Surubelnita electrica • [SR] Električni Odvijač • [MK] Штрафилица • [RU] Электрическая отвёртка • [SL] Izvijač zavijake zagips plošče • [EL] Ηλεκτρικό καταβίδι για γυψοσανίδες
 • [HR] Odvijač • [FR] Tournevis à cloisons sèches • [IT] Cacciavite per cartongesso • [ES] Desegnilo drywall • [PT] Aparafusadora p/ gesso cartonado

RD-ES46

| | | |
|--------------|-------|-----------|
| 230V~50Hz | 520 W | |
| 0-4500 min⁻¹ | 10 Nm | 1.7 kg |
| 1/4" | | COLOR BOX |



ERGONOMIC ON/OFF SWITCH

| Art.No | gross weight | in cartoon | barcode |
|--------|--------------|------------|---------------|
| 073101 | 1.900 kg | 5 pcs | 3800123163616 |

RD-ES47

| | | |
|--------------|-------|-----------|
| 230V~50Hz | 710 W | |
| 0-4000 min⁻¹ | 10 Nm | 1.8 kg |
| 1/4" | | COLOR BOX |



METAL GEAR BOX

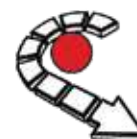

VARIABLE SPEED

| Art.No | gross weight | in cartoon | barcode |
|--------|--------------|------------|---------------|
| 073107 | 2.000 kg | 10 pcs | 3800972010642 |



IMPACT WRENCH

• [BG] Гайковерт ударен • [RO] Pistol de impact • [SR] Zavrtać udarni • [MK] Електронски ударен одвртувач • [RU] Импульсный гайковерт • [SL] Udarni avto vijačnik • [EL] Κρουστικό κλειδί αυτοκίνητου
 • [HR] Udarni odvijač • [FR] Clé à chocs • [IT] Chiave di impatto • [ES] Llave de impacto • [PT] Chave de impacto

RD-EIW07

230V~
50Hz

450
W

0-3000
min⁻¹

350
Nm

1/2" inch



2.9
kg



**NEW
PRODUCT**

ACCESSORIES 4pcs:
Sockets 17,19,21,22 mm



**METAL
GEAR BOX**

| Art.No | gross weight | in cartoon | barcode |
|--------|--------------|------------|---------------|
| 073206 | 3.120 kg | 5 pcs | 3800972016385 |

RD-EIW06

230V~
50Hz

950
W

2300
min⁻¹

450
Nm

1/2" inch



5.400
kg



ACCESSORIES 4pcs:
Sockets 17,19,21,22 mm



**METAL
GEAR BOX**

| Art.No | gross weight | in cartoon | barcode |
|--------|--------------|------------|---------------|
| 073205 | 6 kg | 2 pcs | 3800972010444 |

RD-EIW04

230V~
50Hz

1100
W

2200
min⁻¹

450
Nm

1/2" inch



4.3
kg



**ERGONOMIC ON/OFF
SWITCH**

| Art.No | gross weight | in cartoon | barcode |
|--------|--------------|------------|---------------|
| 073203 | 4.800 kg | 5 pcs | 3800972002555 |

RD-EIW05

230V~
50Hz

1050
W

2200
min⁻¹

500
Nm

1/2" inch



5.3
kg



LCD DISPLAY



**METAL
GEAR BOX**

**ERGONOMIC ON/OFF
SWITCH**

| Art.No | gross weight | in cartoon | barcode |
|--------|--------------|------------|---------------|
| 073204 | 5.900 kg | 4 pcs | 3800972002562 |

ROTARY HAMMER

• [BG] Перфоратор • [RO] Ciocan rotorpercutor • [SR] Čekić bušilica • [MK] Ударен чекан • [RU] Перфоратор • [SL] Rotacijski udarni vrtnik • [EL] Περιστροφικό δραστικό με σφυρί • [HR] Čekić udarni
• [FR] Marteau rotatif • [IT] Martello rotante • [ES] Rotaj hammer • [PT] Martelo perfurador

RD-HD53

| | | |
|---------------------------|-------------|-----------------------------|
| 230V~ 50Hz | 620 W | 0-1000 min ⁻¹ |
| 4850 min ⁻¹ | 2.0 J | |
| | | |
| | SDS+ | |
| | 2.600 kg | |



| Art.No | gross weight | in cartoon | barcode |
|--------|--------------|------------|---------------|
| 013135 | 3.330 kg | 5 pcs | 3800972009189 |

RD-HD54

| | | |
|---------------------------|-------------|-----------------------------|
| 230V~ 50Hz | 750 W | 0-1000 min ⁻¹ |
| 4850 min ⁻¹ | 2.2 J | |
| | | |
| | SDS+ | |
| | 2.800 kg | |



| Art.No | gross weight | in cartoon | barcode |
|--------|--------------|------------|---------------|
| 013136 | 4.070 kg | 5 pcs | 3800972009196 |

RD-HD40

| | | |
|---------------------------|-----------|-----------------------------|
| 230V~ 50Hz | 800 W | 0-1000 min ⁻¹ |
| 4850 min ⁻¹ | 2.2 J | |
| | | |
| | SDS+ | |
| | 4.8 kg | |

ACCESSORIES:
3 drill bits (Ø6 / 8 / 10 x 150mm)
1pc flat chisel (14 x 250mm)
1pc point chisel (14 x 250mm)
1pc depth ruler



| Art.No | gross weight | in cartoon | barcode |
|--------|--------------|------------|---------------|
| 012104 | 5.300 kg | 2 pcs | 3800123173431 |

RD-HD38

| | | |
|---------------------------|-----------|----------------------------|
| 230V~ 50Hz | 800 W | 0-930 min ⁻¹ |
| 5000 min ⁻¹ | 2.5 J | |
| | | |
| | SDS+ | |
| | 5.1 kg | |

ACCESSORIES:
3 drill bits (Ø8/10/12 x 150mm)
1pc flat chisel
1pc point chisel (Ø14 x 250mm)
1bottle grease
1pc dust cover
1pc depth ruler



| Art.No | gross weight | in cartoon | barcode |
|--------|--------------|------------|---------------|
| 013126 | 5.660 kg | 2 pcs | 3800123167003 |

ROTARY HAMMER

• [BG] Перфоратор • [RO] Ciocan rotorpercutor • [SR] Čekić bušilica • [MK] Ударен чекан • [RU] Перфоратор • [SL] Rotacijski udarni vrtalnik • [EL] Περιστροφικό δραστικό με σφυρί • [HR] Čekić udarni
• [FR] Marteau rotatif • [IT] Martello rotante • [ES] Rotaj hammer • [PT] Martelo perfurador

RD-HD51

| | | |
|---------------------------|-------------|----------------------------|
| 230V~ 50Hz | 1050 W | 0-900 min ⁻¹ |
| 5000 min ⁻¹ | 3.4 J | |
| | | |
| | SDS+ | |
| | 3.300 kg | |



SDS+



FOUR FUNCTION

| Art.No | gross weight | in carton | barcode |
|--------|--------------|-----------|---------------|
| 012105 | 3.800 kg | 2 pcs | 3800972008434 |

RDP-HD05S

| | | |
|-----------------------------|----------------|----------------------------|
| 230V~ 50Hz | 750W | 0-980 min ⁻¹ |
| 0-4850 min ⁻¹ | 2.6J | |
| | | |
| | VARIABLE SPEED | |
| | 3 kg | |



SDS+



FOUR FUNCTION

| Art.No | gross weight | in carton | barcode |
|--------|--------------|-----------|---------------|
| 012101 | 4 kg | 3 pcs | 3800123124785 |

RDP-HD12H

| | | |
|-----------------------------|----------------|-----------------------------|
| 230V~ 50Hz | 950W | 0-1200 min ⁻¹ |
| 0-4820 min ⁻¹ | 3J | |
| | | |
| | VARIABLE SPEED | |
| | 3.2 kg | |



RAIDER®
Pro



SDS+



FOUR FUNCTION

| Art.No | gross weight | in carton | barcode |
|--------|--------------|-----------|---------------|
| 012103 | 4.200 kg | 3 pcs | 3800123153884 |

RD-HD52

| | | |
|---------------------------|-----------|----------------------------|
| 230V~ 50Hz | 1010 W | 0-800 min ⁻¹ |
| 4000 min ⁻¹ | 3.5 J | |
| | | |
| | SDS+ | |
| | 6 kg | |

ACCESSORIES:
3 drill bits (Ø8/10/12 x 150mm)
1pc flat chisel
1pc point chisel (Ø14 x 250mm)
1bottle grease
1pc dust cover
1pc depth ruler



SDS+



THREE FUNCTION

| Art.No | gross weight | in carton | barcode |
|--------|--------------|-----------|---------------|
| 013134 | 6.330 kg | 3 pcs | 3800972008915 |

ROTARY HAMMER

• [BG] Перфоратор • [RO] Ciocan rotorpercutor • [SR] Čekić bušilica • [MK] Ударен чекан • [RU] Перфоратор • [SL] Rotacijski udarni vrtnik • [EL] Περιστροφικό δραπάνο με σφυρι • [HR] Čekić udarni • [FR] Marteau rotatif • [IT] Martello rotante • [ES] Rotaj hammer • [PT] Martelo perfurador

RD-HD04

| | | |
|---------------------------|----------|----------------------------|
| 230V~ 50Hz | 850 W | 0-800 min ⁻¹ |
| 2900 min ⁻¹ | 3.5 J | |
| | | |
| SDS+ | | 7.900 kg |

ACCESSORIES:
 SDS+ 08x150 mm drill bit
 SDS+ 10x150 mm drill bit
 SDS+ 12x150 mm drill bit
 SDS+ 14x250 mm flat chisel
 SDS+ 14x250 mm pointed chisel



SDS+



ANTIVIBRATION
HANDLE

| Art.No | gross weight | in cartoon | barcode |
|--------|--------------|------------|---------------|
| 013111 | 8.200 kg | 2 pcs | 3800123160837 |

RD-HD37

| | | |
|---------------------------|-----------|--------------------------|
| 230V~ 50Hz | 1250 W | 730 min ⁻¹ |
| 4000 min ⁻¹ | 3.5 J | |
| | | |
| SDS+ | | 7.4 kg |

ACCESSORIES:
 • 3 drill bits (Ø8/10/12 x 150mm)
 • 1pc flat chisel
 • 1pc point chisel (Ø14 x 250mm)
 • 1bottle grease
 • 1pc dust cover
 • 1pc depth ruler



SDS+



ANTIVIBRATION
HANDLE

| Art.No | gross weight | in cartoon | barcode |
|--------|--------------|------------|---------------|
| 013125 | 8.200 kg | 2 pcs | 3800123167027 |

RD-HD46

| | | |
|-----------------------------|-----------|----------------------------|
| 230V~ 50Hz | 1500 W | 0-850 min ⁻¹ |
| 0-4700 min ⁻¹ | 4.3 J | |
| | | |
| SDS+ | | 7.4 kg |

ACCESSORIES:
 SDS+ 6x150 mm drill bit
 SDS+ 8x150 mm drill bit
 SDS+ 10x150 mm drill bit
 SDS+ 14x250 mm flat chisel
 SDS+ 14x250 mm pointed chisel



SDS+



ANTIVIBRATION
HANDLE



FOUR FUNCTION

| Art.No | gross weight | in cartoon | barcode |
|--------|--------------|------------|---------------|
| 013132 | 8.260 kg | 2 pcs | 3800123174841 |

RD-HD47

| | | |
|-----------------------------|-----------|----------------------------|
| 230V~ 50Hz | 1600 W | 0-850 min ⁻¹ |
| 0-4700 min ⁻¹ | 4.3 J | |
| | | |
| SDS+ | | 7.4 kg |

ACCESSORIES:
 • 3 drill bits (Ø6 / 8 / 10 x 150mm)
 • 1pc flat chisel (Ø14 x 250mm)
 • 1pc point chisel (Ø14 x 250mm)



SDS+



ANTIVIBRATION
HANDLE



FOUR FUNCTION

| Art.No | gross weight | in cartoon | barcode |
|--------|--------------|------------|---------------|
| 013133 | 8.250 kg | 2 pcs | 3800972001503 |

ROTARY HAMMER

• [BG] Перфоратор • [RO] Ciocan rotopercutor • [SR] Čekić bušilica • [MK] Ударен чекан • [RU] Перфоратор • [SL] Rotacijski udarni vrtalnik • [EL] Περιστροφικό δρασάνο με σφυρί • [HR] Čekić udarni • [FR] Marteau rotatif • [IT] Martello rotante • [ES] Rotaj hammer • [PT] Martelo perfurador

RDP-HD35

3 drill bits (Ø8/10/12 x 150mm)
1pc flat chisel
1pc point chisel (Ø14 x 250mm)
1bottle grease
1pc dust cover
1pc depth ruler



RAIDER® Pro

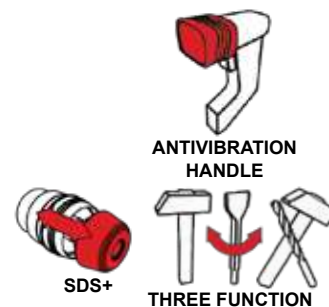

| Art.No | gross weight | in carton | barcode |
|--------|--------------|-----------|---------------|
| 013123 | 8.500 kg | 2 pcs | 3800123165603 |

RDP-HD57

3 drill bits (Ø8/10/12 x 150mm)
1pc flat chisel
1pc point chisel (Ø14 x 250mm)
1bottle grease
1pc dust cover
1pc depth ruler



RAIDER® Pro

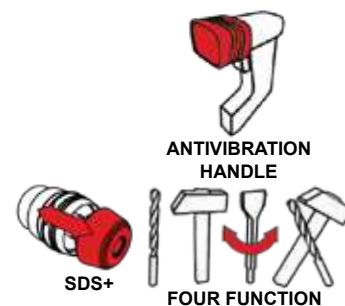

| Art.No | gross weight | in carton | barcode |
|--------|--------------|-----------|---------------|
| 012203 | 9.00 kg | 2 pcs | 3800972016460 |

RDP-HD56

NEW PRODUCT

3 drill bits (Ø8/10/12 x 150mm)
1pc flat chisel
1pc point chisel (Ø14 x 250mm)
1bottle grease
1pc dust cover
1pc depth ruler



RAIDER® Pro

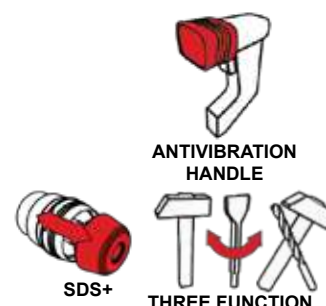

| Art.No | barcode |
|--------|---------------|
| 012202 | 3800972016187 |

RDP-HD39

ACCESSORIES:
3 pcs SDS+ drill bits
SDS+ 14x250 mm flat chisel
SDS+ 250 mm point chisel



RAIDER® Pro

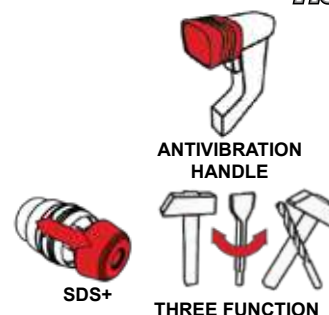

| Art.No | gross weight | in carton | barcode |
|--------|--------------|-----------|---------------|
| 013127 | 7.260 kg | 2 pcs | 3800123167522 |

ROTARY HAMMER

• [BG] Перфоратор • [RO] Ciocan rotorpercutor • [SR] Čekić bušilica • [MK] Ударен чекан • [RU] Перфоратор • [SL] Rotacijski udarni vrtnik • [EL] Περιστροφικό δρασάτο με σφυρί • [HR] Čekić udarni • [FR] Marteau rotatif • [IT] Martello rotante • [ES] Rotaj hammer • [PT] Martelo perfurador

RDP-HD31

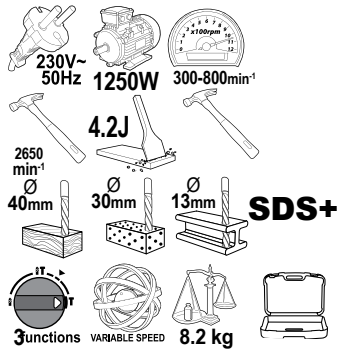

ACCESSORIES:
3 pcs SDS+ drill bits
SDS+ 14x250 mm flat chisel
SDS+ 250 mm point chisel

RAIDER[®]
Pro

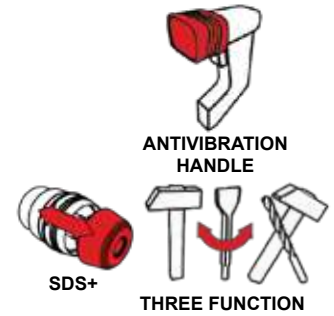

| Art.No | gross weight | in carton | barcode |
|--------|--------------|-----------|---------------|
| 013112 | 9.100 kg | 2 pcs | 3800123160844 |

RDP-HD30

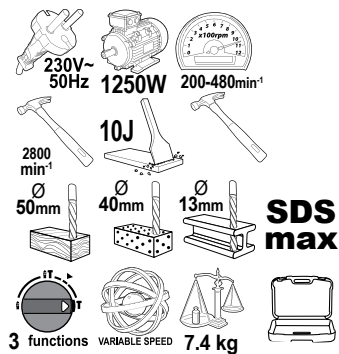

ACCESSORIES:
3 pcs SDS max drill bits
SDS max 14x250 mm flat chisel
SDS max 14x250 mm pointed chisel

RAIDER[®]
Pro

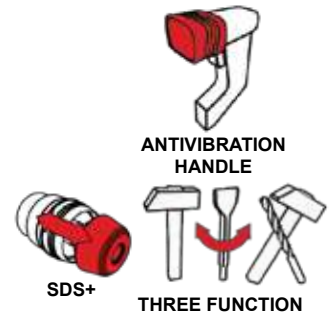

| Art.No | gross weight | in carton | barcode |
|--------|--------------|-----------|---------------|
| 013201 | 8.4 | 2 pcs | 3800123158575 |

RDP-HD55

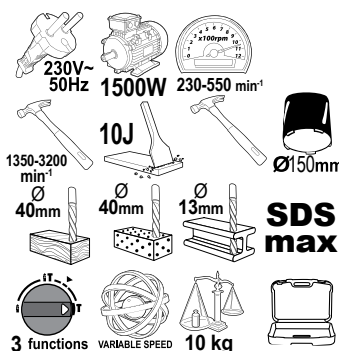

ACCESSORIES:
3 pcs SDS max drill bits
SDS max 14x250 mm flat chisel
SDS max 14x250 mm pointed chisel

RAIDER[®]
Pro

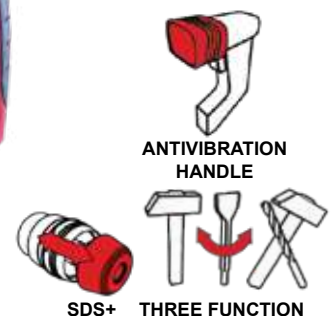

| Art.No | gross weight | in carton | barcode |
|--------|--------------|-----------|---------------|
| 013202 | 11.250 kg | 2 pcs | 3800972009622 |

ACCESSORIES PNEUMATICS RAIDER MACHINES R20 SYSTEM

DEMOLITION HAMMER

• [BG] Къртач • [RO] Ciocan rotopercutor • [SR] Čekić bušilica • [MK] Ударен чекан • [RU] Перфоратор • [SL] Rotacijski udarni vrtnik • [EL] Περιστροφικό δραστικό με σφυρί • [HR] Čekić udarni • [FR] Marteau rotatif • [IT] Martello rotante • [ES] Rotaj hammer • [PT] Martelo perfurador

RDP-DH03

NEW PRODUCT

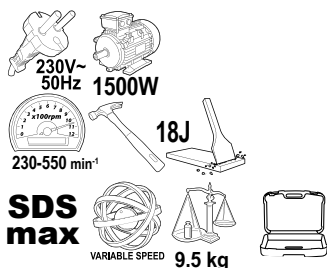

RAIDER® Pro

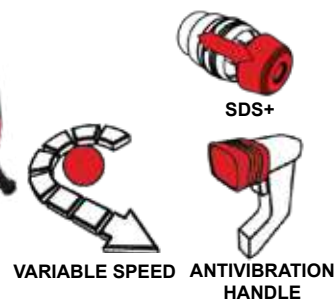

| Art.No | gross weight | in carton | barcode |
|--------|--------------|-----------|---------------|
| 012204 | 10.00 kg | 2 pcs | 3800972016477 |

RD-DH02

NEW PRODUCT



METAL CASE

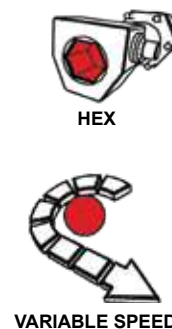



| Art.No | barcode |
|--------|---------------|
| 013137 | 3800972016347 |



ANGLE GRINDER

• [BG] Ъглошлайф • [RO] Polizor unghiular • [SR] Brusilica ugaona • [MK] Брусилка • [RU] Угловая шлифовальная машина • [SL] Kotni brusilnik • [EL] ΓΩΝΙΑΚΟΣ ΤΡΟΧΟΣ • [HR] Kutna brusilica • [FR] Meuleuse à angle • [IT] Smerigliatrice angolare • [ES] Angulo muellelo • [PT] Rebarbadora

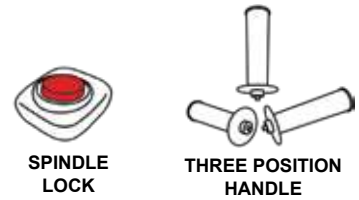

RD-AG49

| | | |
|---|----------|---|
| 230V~ 50Hz | 600 W | |
| 12000 min ⁻¹ | 115 mm | 22.2 mm |
|  | 2 kg |  |



| Art.No | gross weight | in carton | barcode |
|--------|--------------|-----------|---------------|
| 020147 | 2.170 kg | 6 pcs | 3800123166822 |



RD-AG66

| | | |
|---|----------|---|
| 230V~ 50Hz | 600 W | |
| 12000 min ⁻¹ | 115 mm | 22.2 mm |
|  | 2 kg |  |



| Art.No | gross weight | in carton | barcode |
|--------|--------------|-----------|---------------|
| 020154 | 2.170 kg | 6 pcs | 3800972018860 |

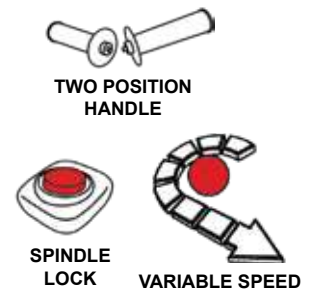

RD-AG25

| | | |
|---|-------------|---|
| 230V~ 50Hz | 900 W |  |
| 3000- 11000 min ⁻¹ | 115 mm | 22.2 mm |
|  | 2.340 kg |  |



| Art.No | gross weight | in carton | barcode |
|--------|--------------|-----------|---------------|
| 020123 | 2.600 kg | 6 pcs | 3800123154928 |

RD-AG34

| | | |
|---|-----------|---|
| 230V~ 50Hz | 650 W | |
| 11000 min ⁻¹ | 125 mm | 22.2 mm |
|  | 2.1 kg |  |



| Art.No | gross weight | in carton | barcode |
|--------|--------------|-----------|---------------|
| 020136 | 2.340 kg | 6 pcs | 3800123162466 |

RD-AG60

| | |
|----------------------------|-------------------|
| 230V~ 50Hz | 750 W |
| 12000 min ⁻¹ | 22,2 mm 125 mm |
| | 2.5 kg |
| | |



SPINDLE
LOCK



TWO POSITION
HANDLE

| Art.No | gross weight | in carton | barcode |
|--------|--------------|-----------|---------------|
| 020153 | 2.700 kg | 6 pcs | 3800972009868 |

RD-AG51

| | |
|----------------------------|-------------------|
| 230V~ 50Hz | 750 W |
| 12000 min ⁻¹ | 22,2 mm 125 mm |
| | 2.9 kg |
| | |



SPINDLE
LOCK



THREE POSITION
HANDLE

| Art.No | gross weight | in carton | barcode |
|--------|--------------|-----------|---------------|
| 020149 | 3.100 kg | 4 pcs | 3800972000780 |

RD-AG36

| | |
|----------------------------|-------------------|
| 230V~ 50Hz | 850 W |
| 11000 min ⁻¹ | 22,2 mm 125 mm |
| | 2.3 kg |
| | |



SPINDLE
LOCK



TWO POSITION
HANDLE

| Art.No | gross weight | in carton | barcode |
|--------|--------------|-----------|---------------|
| 020138 | 2.600 kg | 6 pcs | 3800123162480 |

RD-AG44T

| | |
|----------------------------|-------------------|
| 230V~ 50Hz | 900 W |
| 12000 min ⁻¹ | 22,2 mm 125 mm |
| | 2.300 kg |
| | |



SPINDLE
LOCK



TWO POSITION
HANDLE

| Art.No | gross weight | in carton | barcode |
|--------|--------------|-----------|---------------|
| 020145 | 2.600 kg | 6 pcs | 3800123167355 |

RD-AG37

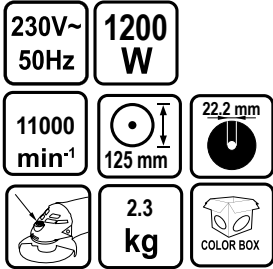

| Art.No | gross weight | in cartoon | barcode |
|--------|--------------|------------|---------------|
| 020139 | 2.500 kg | 6 pcs | 3800123162497 |

RD-AG39

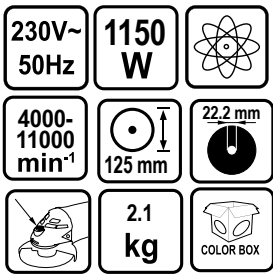

| Art.No | gross weight | in cartoon | barcode |
|--------|--------------|------------|---------------|
| 020140 | 2.300 kg | 6 pcs | 3800123162534 |

RD-AG54

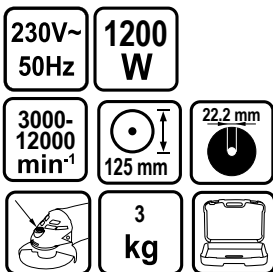

| Art.No | gross weight | in cartoon | barcode |
|--------|--------------|------------|---------------|
| 020152 | 4.0 kg | 4 pcs | 3800972000810 |

RDP-AG21Z

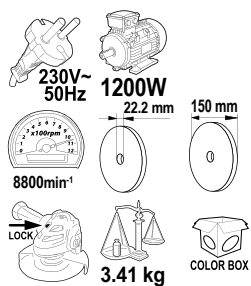

| Art.No | gross weight | in cartoon | barcode |
|--------|--------------|------------|---------------|
| 020118 | 3.790 kg | 4 pcs | 3800123122552 |

RAIDER[®]
Pro

RD-AG10T

| | | |
|---------------|-------------|------------------------------------|
| 230V~ 50Hz | 1400 W | 4000- 8000 min ⁻¹ |
| SOFT START | 180 mm | 22.2 mm |
| | 3.900 kg | COLOR BOX |



THREE POSITION
HANDLE



SPINDLE
LOCK



SOFT START

| Art.No | gross weight | in cartoon | barcode |
|--------|--------------|------------|---------------|
| 020107 | 4.060 kg | 2 pcs | 3800123124617 |

RD-AG38

| | | |
|---------------|-------------|---------------------------|
| 230V~ 50Hz | 2350 W | 6000 min ⁻¹ |
| SOFT START | 230 mm | 22.2 mm |
| | 5.200 kg | COLOR BOX |



ROTATING HANDLE



SPINDLE
LOCK



SOFT START



THREE POSITION
HANDLE

| Art.No | gross weight | in cartoon | barcode |
|--------|--------------|------------|---------------|
| 020201 | 5.760 kg | 2 pcs | 3800123162503 |

RD-AG55

| | | |
|---------------|-----------|---------------------------|
| 230V~ 50Hz | 2350 W | 6500 min ⁻¹ |
| SOFT START | 230 mm | 22.2 mm |
| | 5.1 kg | |



SPINDLE
LOCK



SOFT START



THREE POSITION
HANDLE

| Art.No | gross weight | in cartoon | barcode |
|--------|--------------|------------|---------------|
| 020203 | 5.700 kg | 2 pcs | 3800972000827 |

RD-AG45

| | | |
|---------------|-----------|----------------------------|
| 230V~ 50Hz | 2500 W | 11000 min ⁻¹ |
| SOFT START | 230 mm | 22.2 mm |
| | 6.3 kg | COLOR BOX |



ROTATING HANDLE



SPINDLE
LOCK



SOFT START

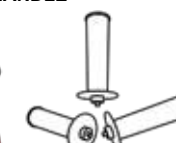

THREE POSITION
HANDLE

| Art.No | gross weight | in cartoon | barcode |
|--------|--------------|------------|---------------|
| 020202 | 6.580 kg | 2 pcs | 3800123171796 |

STRAIGHT GRINDER RDP-DG01

RAIDER
Pro

• [BG] Права шлиф • [RO] Polizor unghiular • [SR] Brusilica ugaona • [MK] Брусилка • [RU] Прямая шлифовальная машина • [SL] Brusilnik • [EL] ΤΡΟΧΟΣ • [HR] Kutna brusilica
• [FR] Meuleuse à angle • [IT] Smerigliatrice angolare • [ES] Angulo muelilo • [PT] Rebarbadora

NEW
PRODUCT

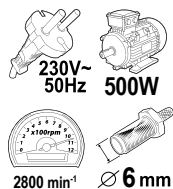

| Art.No | barcode |
|--------|---------------|
| 041602 | 3800972019683 |

JIG SAW

• [BG] Пробоен трион • [RO] Ferstrau pendular • [SR] Ubodna testera • [MK] Убодна пила • [RU] Маятниковый лобзик • [SL] Nihajna vbodna žaga • [EL] Πολινδρομική σιγα • [HR] Ubodna pila
 • [FR] Électrique scie sauteuse • [IT] Sega • [ES] Elektra puzla • [PT] Tico-tico

RD-JS31

| | | |
|--------------------------------|-----------|---------------------------|
| 230V~ 50Hz | 500 W | 3000 min ⁻¹ |
| 65 mm | 6 mm | 45° |
| DUST CAPTURE ПРАХО-УЛАВЛЯНЕ | 2.1 kg | COLOR BOX |



PENDULUM FUNCTION

| Art.No | gross weight | in carton | barcode |
|--------|--------------|-----------|---------------|
| 050126 | 2.200 kg | 10 pcs | 3800972009745 |

RD-JS32

| | | | |
|---------------|--------------------------------|---------------------------|-----------|
| 230V~ 50Hz | 650 W | 3000 min ⁻¹ | |
| 65 mm | 6 mm | 45° | |
| x3 | DUST CAPTURE ПРАХО-УЛАВЛЯНЕ | 2.1 kg | COLOR BOX |



PENDULUM FUNCTION

| Art.No | gross weight | in carton | barcode |
|--------|--------------|-----------|---------------|
| 050127 | 2.200 kg | 10 pcs | 3800972009864 |

RD-JS33

| | | | |
|---------------|--------------------------------|-----------------------------|-------------|
| 230V~ 50Hz | 750 W | 0-3000 min ⁻¹ | |
| 80 mm | 6 mm | 45° | Atom Symbol |
| x3 | DUST CAPTURE ПРАХО-УЛАВЛЯНЕ | 1.900 kg | COLOR BOX |



PENDULUM FUNCTION



QUICK CHANGE SYSTEM

| Art.No | gross weight | in carton | barcode |
|--------|--------------|-----------|---------------|
| 050128 | 2.150 kg | 10 pcs | 3800972009851 |

RD-JS28

| | | | |
|---------------|--------------------------------|-----------------------------|-------------|
| 230V~ 50Hz | 850 W | 0-3000 min ⁻¹ | LASER |
| 80 mm | 10 mm | 45° | Atom Symbol |
| x3 | DUST CAPTURE ПРАХО-УЛАВЛЯНЕ | 2.1 kg | COLOR BOX |



QUICK CHANGE SYSTEM



PENDULUM FUNCTION LASER

| Art.No | gross weight | in carton | barcode |
|--------|--------------|-----------|---------------|
| 050125 | 2.200 kg | 10 pcs | 3800972001190 |

RDP-JS25

RAIDER[®]
Pro

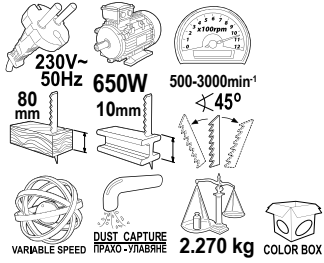

PENDULUM FUNCTION

| Art.No | gross weight | in cartoon | barcode |
|--------|--------------|------------|---------------|
| 050119 | 2.520 kg | 8 pcs | 3800123167232 |

RDP-JS34

**NEW
PRODUCT**

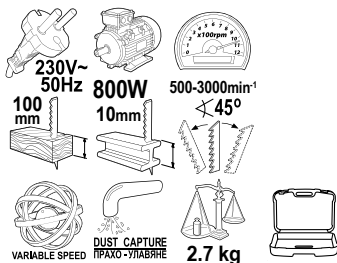

RAIDER[®]
Pro



QUICK CHANGE SYSTEM



PENDULUM FUNCTION LASER

| Art.No | gross weight | in cartoon | barcode |
|--------|--------------|------------|---------------|
| 050203 | 3.00 kg | 5 pcs | 3800972016361 |

RDP-JS21

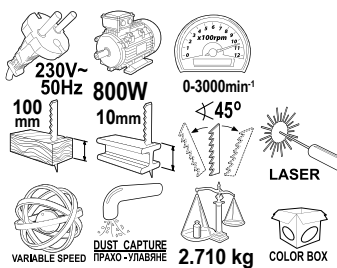

RAIDER[®]
Pro



QUICK CHANGE SYSTEM



PENDULUM FUNCTION LASER

| Art.No | gross weight | in cartoon | barcode |
|--------|--------------|------------|---------------|
| 050201 | 3.020 kg | 10 pcs | 3800123159022 |

RDP-JS26

RAIDER[®]
Pro

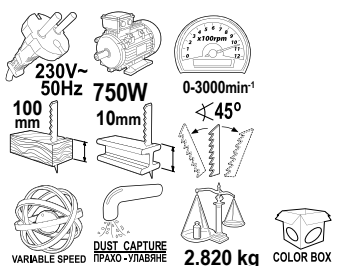

PENDULUM FUNCTION

| Art.No | gross weight | in cartoon | barcode |
|--------|--------------|------------|---------------|
| 050120 | 3.140 kg | 5 pcs | 3800123167249 |

RECIPROCATING SAW

• [BG] Трион саблевиден • [RO] Fierastrau pendular • [SR] Sabljasta testera • [MK] Пила сабјарка • [RU] Маятниковый лобзик • [SL] Nihajna vboдна žaga • [EL] Πριονι σεγά • [HR] Recipro pila • [FR] Scie à mouvement alternative • [IT] Sega universal • [ES] Sierra de sable • [PT] Serra sabre

RD-RS32

**NEW
PRODUCT**

| | | |
|---------------|-------------|-----------------------------|
| 230V~ 50Hz | 900 W | 0-2800 min ⁻¹ |
| 5 mm | 12mm AL | 115 mm |
| | 2.780 kg | COLOR BOX |



QUICK CHANGE SYSTEM

| Art.No | gross weight | in cartoon | barcode |
|--------|--------------|------------|---------------|
| 050131 | 3.000 kg | 4 pcs | 3800972016354 |

RD-RS29

| | | |
|---------------|-------------|-----------------------------------|
| 230V~ 50Hz | 750 W | 900- 3300 min ⁻¹ |
| 8 mm | 12mm AL | 115 mm |
| | 2.480 kg | COLOR BOX |



QUICK CHANGE SYSTEM

| Art.No | gross weight | in cartoon | barcode |
|--------|--------------|------------|---------------|
| 050129 | 2.880 kg | 4 pcs | 3800972010437 |

RDP-RS28

| | | |
|----------------|-------------------------|--|
| | 230V~ 50Hz | |
| 850W | 0-2800min ⁻¹ | |
| VARIABLE SPEED | 115mm | |
| | 6mm | |
| 2.920 kg | COLOR BOX | |



**RAIDER®
Pro**



QUICK CHANGE SYSTEM



ROTATING HANDLE

| Art.No | gross weight | in cartoon | barcode |
|--------|--------------|------------|---------------|
| 050202 | 3.260 kg | 4 pcs | 3800123173202 |



MULTI-TOOL RD-OMT01

• [BG] Многофункционален инструмент • [RO] Unealta multifunctionala • [SR] Višenamenski alat • [MK] Повеќенаменски алат • [RU] Многофункциональный инструмент • [SL] Večnamensko orodje • [EL] Πολυεργαλείο μπαταρίας • [HR] Višenamjenski alat • [FR] Outil multifonctionnel • [IT] Multi-utensile oscillante • [ES] Herramienta multifuncional • [PT] Multi-ferramenta oscilante

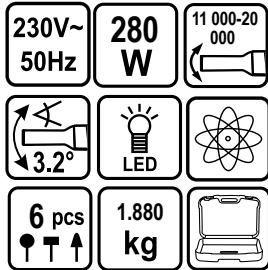

CUTTING AND GRINDING

| Art.No | gross weight | in cartoon | barcode |
|--------|--------------|------------|---------------|
| 050115 | 2.070 kg | 5 pcs | 3800123163623 |

SANDER

• [BG] Виброшлайф • [RO] Slefuitor cu vibratii • [SR] Brusilica vibraciona • [MK] Виброшлјаферица • [RU] Шлифмашина вибрационная • [SL] Vibracijski brusilnik • [EL] Τριβείο • [HR] Jednoručna brusilica • [FR] Ponceuse électrique • [IT] Sanderia elettrica • [ES] Elektra sandero • [PT] Lixadora

RD-SA26



DUST AWAY SWITCH LOCK

| Art.No | gross weight | in cartoon | barcode |
|--------|--------------|------------|---------------|
| 040115 | 2.0 kg | 10 pcs | 3800972010413 |

RD-SA08



ALUMINIUM BASE



DUST AWAY SWITCH LOCK

| Art.No | gross weight | in cartoon | barcode |
|--------|--------------|------------|---------------|
| 040112 | 2.310 kg | 8 pcs | 3800123160813 |



SANDER

• [BG] Виброшлайф • [RO] Slefuitor cu vibratii • [SR] Brusilica vibraciona • [MK] Виброшлјаферица • [RU] Шлифмашина вибрационная • [SL] Vibracijski brusilnik
 • [EL] Τριβείο • [HR] Jednoručna brusilica • [FR] Ponceuse électrique • [IT] Sanderia elettrica • [ES] Elektra sandero • [PT] Lixadora

RD-SA19

| | | |
|--------------------------------|-------------|-------------------------------------|
| 230V~ 50Hz | 350 W | 6000- 11000 min ⁻¹ |
| | | |
| DUST CAPTURE ПРАХО-УЛАВЉАЊЕ | 2.440 kg | |
| | | COLOR BOX |



ALUMINIUM BASE



DUST AWAY

SWITCH LOCK

| Art.No | gross weight | in carton | barcode |
|--------|--------------|-----------|---------------|
| 040111 | 1.710 kg | 8 pcs | 3800123151477 |

RDP-SA22

| | | |
|--|--------------------------------|------------------------------|
| | 230V~ 50Hz | |
| | 200W | 6000-12000 min ⁻¹ |
| | 115mm | VELCRO |
| | DUST CAPTURE ПРАХО-УЛАВЉАЊЕ | 1.850 kg |
| | | COLOR BOX |



RAIDER®
Pro



ALUMINIUM BASE



DUST AWAY

SWITCH LOCK

| Art.No | gross weight | in carton | barcode |
|--------|--------------|-----------|---------------|
| 040401 | 2.060 kg | 5 pcs | 3800123167263 |

RDP-SA23

| | | |
|--|--------------------------------|------------------------|
| | 230V~ 50Hz | |
| | 320W | 2000 min ⁻¹ |
| | 115mm | 230mm |
| | VELCRO | VARIABLE SPEED |
| | DUST CAPTURE ПРАХО-УЛАВЉАЊЕ | 2.360 kg |
| | | COLOR BOX |



RAIDER®
Pro



ALUMINIUM BASE



DUST AWAY

SWITCH LOCK

| Art.No | gross weight | in carton | barcode |
|--------|--------------|-----------|---------------|
| 040402 | 2.620 kg | 4 pcs | 3800123167270 |

RANDOM ORBIT SANDER

• [BG] Ексцентършлиф • [RO] Slefuitor orbital • [SR] Brusilica rotaciona • [MK] Ексцентрична брусилка • [RU] Эксцентровые шлифовальные машины • [SL] Ekscentrični brusilnik • [EL] Εκκεντρο τρίβειο
 • [HR] Ekscentrična brusilica • [FR] Ponceuse excentrique • [IT] Levigatrice orbitale • [ES] Lijadora de órbita • [PT] Lixadora orbital

RD-RSA05



| | | |
|-------------------------------|-------------|-------------------------------------|
| 230V~ 50Hz | 450 W | 6000- 11000 min ⁻¹ |
| Ø 125 mm | | |
| DUST CAPTURE ПРАХО-УЛАВЯНЕ | 1.910 kg | COLOR BOX |

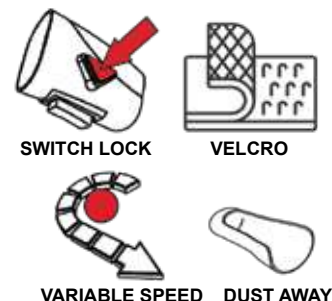

| Art.No | barcode |
|--------|---------------|
| 040116 | 3800972016705 |

RD-RSA03

| | | |
|-------------------------------|-------------|-------------------------------------|
| 230V~ 50Hz | 420 W | 6000- 11000 min ⁻¹ |
| Ø 125 mm | | |
| DUST CAPTURE ПРАХО-УЛАВЯНЕ | 1.810 kg | COLOR BOX |

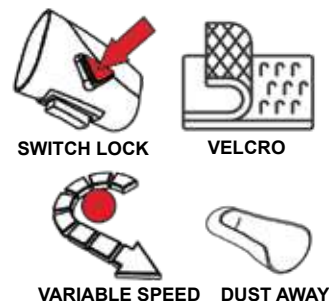

| Art.No | gross weight | in carton | barcode |
|--------|--------------|-----------|---------------|
| 042102 | 2.220 kg | 8 pcs | 3800123151484 |

RDP-RSA04

RAIDER[®]
Pro

| | |
|-------------------------------|----------------|
| 230V~ 50Hz | 380W |
| 6000-13000 min ⁻¹ | Ø150mm |
| VELCRO | VARIABLE SPEED |
| DUST CAPTURE ПРАХО-УЛАВЯНЕ | 2.200 kg |
| COLOR BOX | |

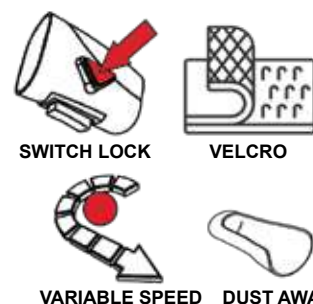

| Art.No | gross weight | in carton | barcode |
|--------|--------------|-----------|---------------|
| 042201 | 2.450 kg | 6 | 3800123167256 |

BELT SANDER

• [BG] Лентов шлайф • [RO] Slefuitor electric cu banda • [SR] Vibrirajuća brusilica • [MK] Шлијаферица кружна • [RU] Шлифмашина ленточная • [SL] Tračni brusilnik • [EL] Ταϊνολειαντήρας
 • [HR] Трачна brusilica • [FR] Ponceuse à bande • [IT] Levigatrice a nastro • [ES] Litroj brusher • [PT] Lixadora

RD-BS06

| | | |
|--------------------------------------|------------------|--------------------------------------|
| 230V~ 50Hz | 950 W | 11500- 32000 min ⁻¹ |
| 75x533mm | 150-380 m/min | |
| DUST CAPTURE ПРАХО- УЛАВЯНЕ | 3.655 kg | |



| Art.No | gross weight | in cartoon | barcode |
|--------|--------------|------------|---------------|
| 043105 | 4.000 kg | 6 pcs | 3800123158957 |

RDP-BS07

| | | |
|--|-------------------------------|------------------|
| | 230V~ 50Hz | |
| | 1010W | 120-380 m/min |
| | 76x533 mm | VARIABLE SPEED |
| | DUST CAPTURE ПРАХО-УЛАВЯНЕ | 3.60 kg |
| | COLOR BOX | |



**RAIDER®
Pro**



| Art.No | gross weight | in cartoon | barcode |
|--------|--------------|------------|---------------|
| 043201 | 4.00 kg | 6 pcs | 3800123158940 |

DRYWALL SANDER

• [BG] Шлайфмашина за стени и тавани • [RO] Slefuitor pentru pereti • [SR] Brusilice za zid i plafon • [MK] Машина За полирање на ѕидови и плафони • [RU] Машинка шлифовальная
 • [SL] Brusilnik za stene • [EL] Τριβείο Τοίχων Γυψοσανίδας • [HR] Zidna brusilica • [FR] Ponceuse de cloison sèche • [IT] Levigatrice per cartongesso • [ES] Sander por muro • [PT] Lixadora de parede

RD-DS05

| | | |
|--------------------------------------|-------------|------------------------------------|
| 230V~ 50Hz | 750 W | 800 - 1750 min ⁻¹ |
| | ∅ 225mm | |
| DUST CAPTURE ПРАХО- УЛАВЯНЕ | 4.500 kg | |

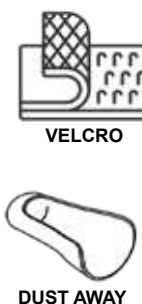

| Art.No | gross weight | in cartoon | barcode |
|--------|--------------|------------|---------------|
| 049907 | 5.000 kg | 1 pcs | 3800972009202 |

RDP-DS02

RAIDER[®]
Pro

| | |
|------------------------------------|-----------|
| 230V~ 50Hz | 710 W |
| 450 - 1700 min ⁻¹ | Ø 225 mm |
| LED | |
| DUST CAPTURE ПРАХО- УЛАВЛЯНЕ | |
| 6.7 kg | COLOR BOX |

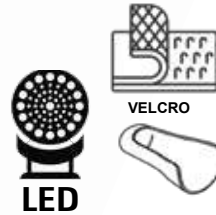

| Art.No | gross weight | barcode |
|--------|--------------|---------------|
| 049903 | 7.800 kg | 3800123166068 |

RD-DS06



| | | |
|------------------------------------|-------------|------------------------------------|
| 230V~ 50Hz | 750 W | 800 - 1750 min ⁻¹ |
| Ø 225 mm | LED | |
| DUST CAPTURE ПРАХО- УЛАВЛЯНЕ | 3.800 kg | COLOR BOX |

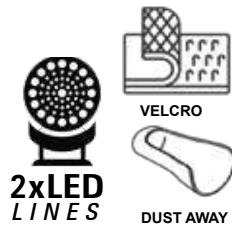

| Art.No | gross weight | barcode |
|--------|--------------|---------------|
| 049906 | 5.000 kg | 3800972009165 |

DUST BAG FOR DRYWALL SANDER RD-DS06



| Art.No | gross weight | barcode |
|--------|--------------|---------------|
| 049908 | 2.100 kg | 3800972010178 |

RD-DS07

**NEW
PRODUCT**



2 HEADS

| | | |
|------------------------------------|-------------|------------------------------------|
| 230V~ 50Hz | 750 W | 800 - 1750 min ⁻¹ |
| Ø 225 mm | LED | |
| DUST CAPTURE ПРАХО- УЛАВЛЯНЕ | 4.500 kg | COLOR BOX |



| Art.No | gross weight | in cartoon | barcode |
|--------|--------------|------------|---------------|
| 049909 | 7.500 kg | 1 pcs | 3800972019737 |

RD-DS03



2 HEADS

| | | |
|-------------------------------|-----------|-------------------------------------|
| 230V~ 50Hz | 710 W | 1200 - 2500 min ⁻¹ |
| ∅ 225 mm | | |
| DUST CAPTURE ПРАХО-УЛАВЯНЕ | 6.7 kg | |

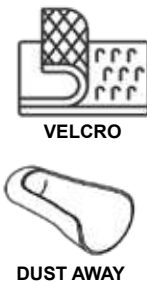

| Art.No | gross weight | in carton | barcode |
|--------|--------------|-----------|---------------|
| 049904 | 7.500 kg | 1 pcs | 3800972002029 |

CIRCULAR SAW

• [BG] Циркулар ръчен • [RO] Fierastrau circular • [SR] Ručni cirkular • [MK] Циркулар рачен • [RU] Дисковая пила • [SL] Krožna žaga • [EL] Δίσκoσ οπτριοv • [HR] Ručna kružna pila • [FR] Meuleuse d'angle • [IT] Sega circolare • [ES] Amoladora angular • [PT] Serra circular

RD-CS24



| | | |
|---------------|-------------------|---------------------------|
| 230V~ 50Hz | 480 W | 4000 min ⁻¹ |
| ∅ [mm] 85 | 27 mm (max) | 1.820 kg |
| | | |

| Art.No | gross weight | in carton | barcode |
|--------|--------------|-----------|---------------|
| 052108 | 3.580 kg | 4 pcs | 3800123166099 |

RD-CS25

FOR METAL AND WOOD



ADJUSTABLE CUTTING DEPTH



LASER

| | | |
|------------------|-------------------|---------------------------|
| 230V~ 50Hz | 710 W | 4300 min ⁻¹ |
| ∅ [mm] 110x20 | 35 mm (max) | WOOD |
| METAL | LASER | 3.6 kg |
| | | COLOR BOX |

| Art.No | gross weight | in carton | barcode |
|--------|--------------|-----------|---------------|
| 052109 | 4.000 kg | 2 pcs | 3800123167362 |

RD-CS28

NEW PRODUCT



MULTI PURPOSE

- ▶ STONE
- ▶ TILES
- ▶ BRICKS
- ▶ CONCRETE
- ▶ MARBLE



ADJUSTABLE CUTTING DEPTH

| | | |
|------------------|-------------------|----------------------------|
| 230V~ 50Hz | 1480 W | 13800 min ⁻¹ |
| ∅ [mm] 110x20 | 35 mm (max) | |
| 3 kg | COLOR BOX | |

| Art.No | gross weight | in carton | barcode |
|--------|--------------|-----------|---------------|
| 052111 | 3.380 kg | 8 pcs | 3800972016323 |

CIRCULAR SAW

• [BG] Циркулар ръчен • [RO] Fierastrau circular • [SR] Ručni cirkular • [MK] Циркулар рачен • [RU] Дисковая пила • [SL] Krožna žaga • [EL] Δίσκ οτρίονο • [HR] Ručna kružna pila • [FR] Meuleuse d'angle
• [IT] Sega circolare • [ES] Amoladora angular • [PT] Serra circular

RD-CS210

| | |
|---------------------------|--------------------|
| 230V~ 50Hz | 1300 W |
| 185x20x24T 80T | 65 mm (max) |
| 4700 min ⁻¹ | 0-45° |
| 3.950 kg | LASER COLOR BOX |



| Art.No | gross weight | in cartoon | barcode |
|--------|--------------|------------|---------------|
| 052106 | 3.580 kg | 4 pcs | 3800123159039 |

RD-CS22

| | |
|---------------------------|-------------------|
| 230V~ 50Hz | 1500 W |
| 190x20x24T 80T | 70 mm (max) |
| 4500 min ⁻¹ | 0-45° |
| 4.020 kg | COLOR BOX |



| Art.No | gross weight | in cartoon | barcode |
|--------|--------------|------------|---------------|
| 052201 | 4.760 kg | 4 pcs | 3800123159046 |

RDP-CS26X

| | | |
|-------------------|-----------|-----------------------|
| 230V~ 50Hz | 1350W | 4700min ⁻¹ |
| 65 mm (max) | 190x20 | 0-45° |
| 4.16 kg | COLOR BOX | |



| Art.No | gross weight | in cartoon | barcode |
|--------|--------------|------------|---------------|
| 052110 | 4.320 kg | 4 pcs | 3800123167621 |

RAIDER[®]
Pro

PLANER

• [BG] Ренде електрическо • [RO] Rindea electrica • [SR] Električno rende • [MK] Рачен абрихтер • [RU] Рубанок • [SL] Utorni oblič • [EL] Ηλεκτρική πλάνη • [HR] Jednoručna blanja • [FR] Rabot électrique [IT] Pialla elettrica • [ES] Elektra ebenajo • [PT] Plaina eléctrica

RD-EP130

| | | |
|--------------------------------------|-----------|-----------------------------|
| 230V~ 50Hz | 710 W | 16 000 min ⁻¹ |
| 0-12mm | 0-2 mm | 82 mm |
| DUST CAPTURE ПРАХО- УЛАВЯНЕ | 2.9 kg | COLOR BOX |



ADJUSTABLE
CUTTING DEPTH

| Art.No | gross weight | in carton | barcode |
|--------|--------------|-----------|---------------|
| 055105 | 3.260 kg | 6 pcs | 3800123158933 |

RD-EP12

| | | |
|--------------------------------------|-----------|-----------------------------|
| 230V~ 50Hz | 850 W | 16 000 min ⁻¹ |
| 0-12.5mm | 0-3 mm | 82 mm |
| DUST CAPTURE ПРАХО- УЛАВЯНЕ | 3.1 kg | COLOR BOX |



ADJUSTABLE
CUTTING DEPTH



TWO SIDED
DUST AWAY

| Art.No | gross weight | in carton | barcode |
|--------|--------------|-----------|---------------|
| 055201 | 3.500 kg | 6 pcs | 3800123158926 |

RDP-EP15

| | | | |
|---------------|---------|-----------|--------------------------|
| 230V~ 50Hz | 900W | 0-3 mm | 16 500 min ⁻¹ |
| 82 mm | 3.67 kg | COLOR BOX | |



RAIDER®
Pro

WITH STAND



ADJUSTABLE
CUTTING DEPTH

| Art.No | gross weight | in carton | barcode |
|--------|--------------|-----------|---------------|
| 055202 | 4.650 kg | 4 pcs | 3800972016378 |

RDP-EP10S

| | | | |
|---------------|---------|-----------|--------------------------|
| 230V~ 50Hz | 950W | 0-4 mm | 16 500 min ⁻¹ |
| 82 mm | 3.67 kg | COLOR BOX | |



RAIDER®
Pro



ADJUSTABLE
CUTTING DEPTH

| Art.No | gross weight | in carton | barcode |
|--------|--------------|-----------|---------------|
| 055102 | 4.080 kg | 6 pcs | 3800123122927 |

ROUTER

• [BG] Оберфреза • [RO] Freza electrica • [SR] Glodalica • [MK] Фреза • [RU] Фрезер • [SL] Nadrezkar • [EL] Ηλεκτρικό router • [HR] Vertikalna glodalica • [FR] Électrique scie sauteuse • [IT] Router elettrico • [ES] Elektra router • [PT] Roteador elétrico

RD-ER07

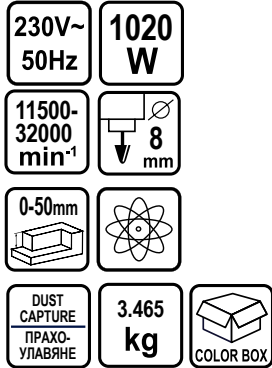

VARIABLE SPEED



DEPTH CONTROL

| Art.No | gross weight | in carton | barcode |
|--------|--------------|-----------|---------------|
| 051102 | 4.260 kg | 4 pcs | 3800123124518 |

RDP-ER13

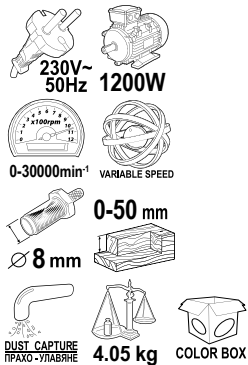

RAIDER[®]
Pro



VARIABLE SPEED



DEPTH CONTROL

| Art.No | gross weight | in carton | barcode |
|--------|--------------|-----------|---------------|
| 051108 | 4.500 kg | 4 pcs | 3800123162510 |

ROUTER TABLE RD-RT01

• [BG] Маса работна за оберфреза • [RO] Masa pentru frezare • [SR] Radni sto za glodalica • [MK] Маса работна за фрезер • [RU] Фрезеровочный стол • [SL] Delovna miza za nadrezkar • [EL] Τραπέζι ρούτερ • [HR] Radni stol za glodalica • [FR] Table de routeur • [IT] Tavolo del router • [ES] Router-tablo • [PT] Mesa de fresa

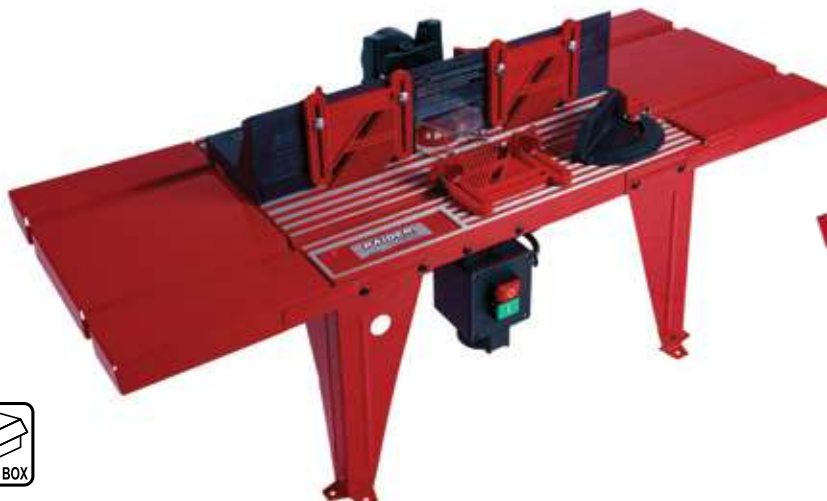
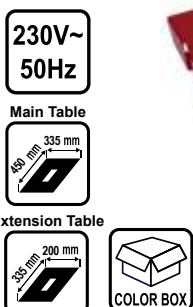

| Art.No | gross weight | in carton | barcode |
|--------|--------------|-----------|---------------|
| 059907 | 6.500 kg | 4 pcs | 3800123123467 |

BISCUIT JOINTER RD-BJO1

• [BG] Фреза за плоски дибли (Бисквит Машина) • [RO] Freză pentru dibluri plate • [SR] Glodalica Za žljebove • [MK] Глодалка за жлеbove • [RU] Фрезы для плоских шкантов • [SL] Lamelni rezkalnik • [EL] Φρεζοκαθλιέρα [HR] Glodalica za ure • [FR] Fraises pour chevilles plates • [IT] Frese per tasselli piatti • [ES] Tranciløj por ebenaj dokaloj • [PT] Túrpi angular



ADJUSTABLE
CUTTING DEPTH

| Art.No | gross weight | in cartoon | barcode |
|--------|--------------|------------|---------------|
| 059906 | 6.000 kg | 4 pcs | 3800123123443 |



ELECTRIC STAPLER

• [BG] Такер електрически комбиниран • [RO] Capsator electric • [SR] Heftalica električna • [MK] Хефталица електрична • [RU] Электрический степлер • [SL] Električni spenjalnik • [EL] Ηλεκτρικό Συρραπτικό • [HR] Pištolj za klamerice • [FR] Agrafeuse électrique • [IT] Cucitrice meccanica elettrica • [ES] Elektra grapilo • [PT] Agrafador elétrico

RD-ES15

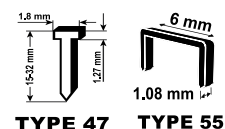

| Art.No | gross weight | in cartoon | barcode |
|--------|--------------|------------|---------------|
| 129998 | 0.860 kg | 10 pcs | 3800123133725 |

RD-ES16

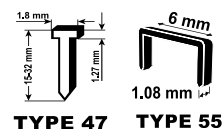

| Art.No | gross weight | in cartoon | barcode |
|--------|--------------|------------|---------------|
| 059601 | 1.560 kg | 10 pcs | 3800123167959 |

WET AND DRY VACUUM CLEANER

• [BG] Прахосмукачка за сухо и мокро • [RO] Aspirator umed/uscat • [SR] Usisivača za mokro i suvo • [MK] Правосмукалка за суво и мокро • [RU] Мокрый и сухой пылесос • [SL] Sesalnik za mokro in suho • [EL] Ηλεκτρική σκούπα για υγρά και ξηρά • [HR] Usisavač za mokre i suhe podloge • [FR] Aspirateur humide et sec • [IT] Aspirapolvere a umido ea secco • [ES] Malseca kaj seka malplena • [PT] Aspirador "WET & DRY"

RD-WC08

| | |
|------------------|------------------------|
| 230V~ 50Hz | 1250 W |
| 15L | 1.3m ³ /min |
| VACUUM 15 kPa | 2.0m |
| 4 kg | |
| COLOR BOX | |

**NEW
PRODUCT**



**FOR DRY AND WET
OPERATION**

| Art.No | gross weight | barcode |
|--------|--------------|---------------|
| 090317 | 4.900 kg | 3800972015869 |

RD-WC01

| | |
|------------------|------------------------|
| 230V~ 50Hz | 1250 W |
| 18L | 1.3m ³ /min |
| VACUUM 16 kPa | 2.3m |
| 5.700 kg | |
| COLOR BOX | |



VACUUM CLEANER BAGS RD-WC01



| Art.No | gross weight | barcode |
|--------|--------------|---------------|
| 090301 | 6.000 kg | 3800123166990 |

| Art.No | barcode |
|--------|--------------|
| 090306 | 380097200759 |

RD-WC09

| | |
|------------------|------------------------|
| 230V~ 50Hz | 1250 W |
| 20L | 4.1m ³ /min |
| VACUUM 15 kPa | 2.0m |
| 4.600 kg | |
| COLOR BOX | |

**NEW
PRODUCT**



**FOR DRY AND WET
OPERATION**

| Art.No | gross weight | barcode |
|--------|--------------|---------------|
| 090318 | 5.500 kg | 3800972015876 |

RD-WC10

| | |
|------------------|------------------------|
| 230V~ 50Hz | 1250 W |
| 20L | 4.1m ³ /min |
| VACUUM 18 kPa | 2.5m |
| 5 kg | |
| COLOR BOX | |

**NEW
PRODUCT**



**INOX
CONTAINER**

**FOR DRY AND WET
OPERATION**

| Art.No | gross weight | barcode |
|--------|--------------|---------------|
| 090321 | 5.500 kg | 3800972015913 |

WET AND DRY VACUUM CLEANER

• [BG] Прахосмукачка за сухо и мокро • [RO] Aspirator umed/uscat • [SR] Usisivača za mokro i suvo • [MK] Правосмукалка за суво и мокро • [RU] Мокрый и сухой пылесос • [SL] Sesalnik za mokro in suho • [EL] Ηλεκτρική σκούπα για υγρή και ξηρή • [HR] Usisivač za mokre i suhe podloge • [FR] Aspirateur humide et sec • [IT] Aspirapolvere a umido ea secco • [ES] Malseka kaj seka malplena • [PT] Aspirador "WET & DRY"

RD-WC07

**NEW
PRODUCT**



| Art.No | gross weight | in cartoon | barcode |
|--------|--------------|------------|---------------|
| 090316 | 6.100 kg | | 3800972015852 |

RDP-WC04

**RAIDER®
Pro**

- Synchronizatin function
- Electrical socket for electric tools
- Water drain outlet
- Hepa filter
- Self-cleaning function
- Stainless steel container
- Metal telescopic tube
- Standard accessories

INOX



HEPA FILTER

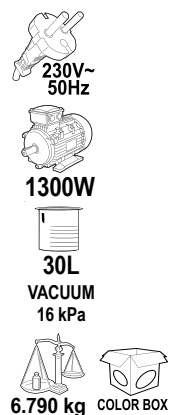

VACUUM CLEANER BAGS RD-WC04



| Art.No | gross weight | barcode |
|--------|--------------|---------------|
| 090310 | 7.300 kg | 3800972012622 |

| Art.No | gross weight | barcode |
|--------|--------------|---------------|
| 090312 | 0.120 kg | 3800972014978 |

ASH VACUUM CLEANER RD-WC06

• [BG] Прахосмукачка за пепел • [RO] Aspirator pentru cenusa • [SR] Usisivač za pepeo • [MK] Правосмукалка за пепел • [RU] Пепла пылесос • [SL] Sesalnik pepela • [EL] Σκούπα φίλτρο σταχτήσ • [HR] Usisivač za uklanjanje pepela • [FR] Aspirateur de cendre • [IT] Aspirapolvere per cenere • [ES] Ash malplena • [PT] Aspirador de cinzas

**NEW
PRODUCT**



WITH BLOWER FUNCTION



| Art.No | gross weight | barcode |
|--------|--------------|---------------|
| 090314 | 3.800 kg | 3800972015838 |

ASH VACUUM CLEANER

• [BG] Прахосмукачка за пепел • [RO] Aspirator pentru cenusa • [SR] Usisivač za pepeo • [MK] Правосмукалка за пепел • [RU] Пепла пылесос • [SL] Sesalnik pepela • [EL] Σκούπα φίλτρο σταχτήρι
 • [HR] Usisivač za uklanjanje pepela • [FR] Aspirateur de cendre • [IT] Aspirapolvere per cenere • [ES] Ash malplena • [PT] Aspirador de cinzas

RD-WC02

| | | |
|---------------|--------------------|-----------|
| 230V~ 50Hz | 1000 W | 18L |
| 24.8L/S | VACUUM 15.5 kPa | |
| 1.5m | 3.600 kg | COLOR BOX |



HEPA FILTER



METAL CONTAINER



TELESCOPIC PIPE

| Art.No | gross weight | in cartoon | barcode |
|--------|--------------|------------|---------------|
| 090304 | 4.300 kg | 1 | 3800123173448 |

RD-WC05



| | | |
|---------------|--------------------|-----------|
| 230V~ 50Hz | 1000 W | 18L |
| 1300L/min | VACUUM 15.5 kPa | |
| 2m | 3.700 kg | COLOR BOX |



WITH WHEELS



METAL CONTAINER



TELESCOPIC PIPE

| Art.No | gross weight | in cartoon | barcode |
|--------|--------------|------------|---------------|
| 090313 | 4.300 kg | 1 | 3800972015821 |

RD-WC03

| | | |
|---------------|------------------|-----------|
| 230V~ 50Hz | 1200 W | 30L |
| 24.8L/S | VACUUM 18 kPa | |
| 3m | 4.2 kg | COLOR BOX |



METAL CONTAINER



TELESCOPIC PIPE

| Art.No | gross weight | in cartoon | barcode |
|--------|--------------|------------|---------------|
| 090308 | 5.000 kg | 1 | 3800972008823 |

METAL ASH CLEANER WITH HEPA FILTER

• [BG] Контейнер метален с HEPA филтър за прахосмукачка • [RO] Recipient pentru cenusa • [SR] Filter za pepeo • [MK] Сад за пепел • [RU] Контейнер для пепла для пылесос • [SL] Posoda za pepel
 • [EL] Φίλτρο στάχτησι για Ηλεκτρική σκούπα • [HR] Posuda za pepeo • [FR] Aspirateur de cendre • [IT] Aspirapolvere per cenere • [ES] Ash malplena • [PT] Aspirador de cinzas



800mm



18L



300x270mm



2.800
kg



COLOR BOX



METAL CONTAINER



TELESCOPIC PIPE

| Art.No | gross weight | in cartoon | barcode |
|--------|--------------|------------|---------------|
| 090303 | 3.100 kg | | 3800123169694 |

MITRE SAW

• [BG] Циркулар настолен с двустранно наклоняне • [RO] Ferestrau circular • [SR] Pokretna kružna testera • [MK] Циркулар столен • [RU] Торцовочная пила • [SL] Radialna zajeralna žaga
 • [EL] Ηδίσκοπρίονο για ξύλο • [HR] Kružna pila • [FR] Scie à onglet • [IT] Formare sega • [ES] Formando sa • [PT] Serra de esquadria

TABLE SAW RD-TS20



• Асинхронен електрически двигател
 • Asynchronous electric motor



| Art.No | gross weight | barcode |
|--------|--------------|---------------|
| 054105 | 11.000 kg | 3800123159220 |

RD-MS02

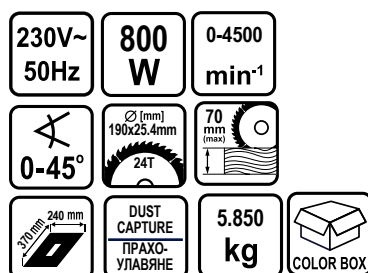

| Art.No | gross weight | barcode |
|--------|--------------|---------------|
| 053100 | 6.500 kg | 3800123154690 |

RD-MS21

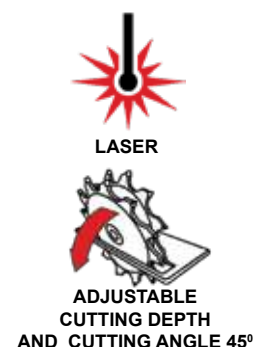
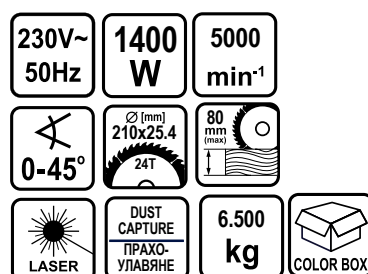

| Art.No | gross weight | barcode |
|--------|--------------|---------------|
| 053102 | 8.000 kg | 3800123123856 |

RD-MS06

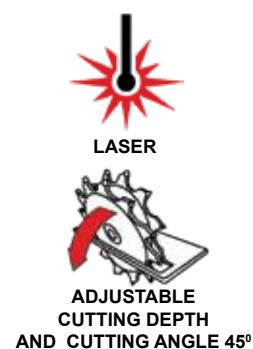
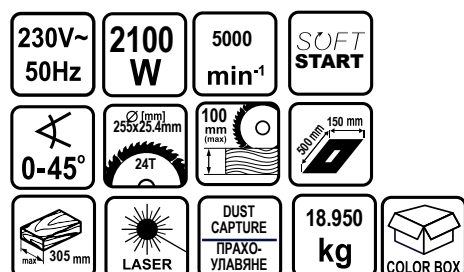

| Art.No | gross weight | barcode |
|--------|--------------|---------------|
| 053104 | 20.000 kg | 3800123123156 |

COMBINATION TABLE AND MITRE SAW RD-MS10

• [BG] Циркулар настолен комбиниран • [RO] Fierastrau circular semi-stationar si de masa • [SR] Testera kružna kombinovana stacionarna • [MK] Циркулар за дрво столен • [RU] Торцовочная пила
 • [SL] Radialna zajeralna žaga • [EL] Δισκοκόπριο Για Ξυλο • [HR] Potezno-nagibna pila • [FR] Banc de scie • [IT] Sega da tavolo • [ES] Tablo vidis • [PT] Serra de esquadria

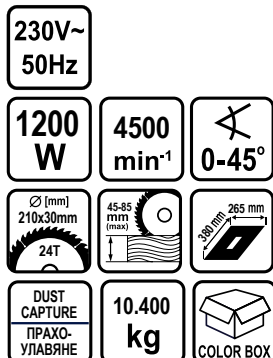

TABLE SAW OPTION



LASER



ADJUSTABLE
CUTTING DEPTH
AND CUTTING ANGLE 45°

| Art.No | gross weight | in cartoon | barcode |
|--------|--------------|------------|---------------|
| 054104 | 12.060 kg | 1 | 3800123141911 |

MITRE SAW DOUBLE BEWEL RDP-MS11

• [BG] Циркулар настолен с двустранно наклоняне • [RO] Ferestru circular • [SR] Pokretna kružna testera • [MK] Циркулар столен • [RU] Торцовочная пила • [SL] Radialna zajeralna žaga
 • [EL] Ηδισκοκόπριο για ξυλο • [HR] Kružna pila • [FR] Scie à onglet • [IT] Formare sega • [ES] Formando sa • [PT] Serra de esquadria

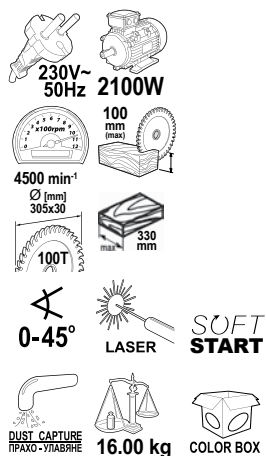

RAIDER®
Pro



LASER



ADJUSTABLE
CUTTING DEPTH
AND CUTTING ANGLE 45°

| Art.No | gross weight | in cartoon | barcode |
|--------|--------------|------------|---------------|
| 053108 | 20.000 kg | 1 | 3800972010109 |

BAND SAW RD-BSW18

• [BG] Банциг • [RO] Ferestrau pendular de banc • [SR] Trakasta testera • [MK] Трaчнa пилa • [RU] Ленточная пилa • [SL] Трачна žaga • [EL] Πριονοκορδέλα • [HR] Трачна пилa • [FR] Scie à ruban
• [IT] Sega a nastro • [ES] Bando vidis • [PT] Serra de mesa

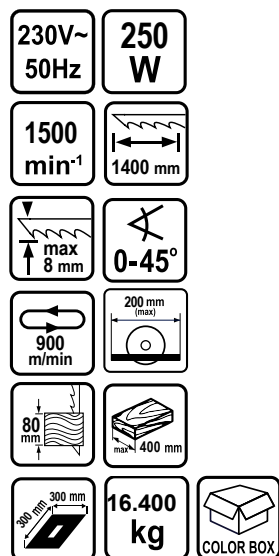

• Асинхронен електрически двигател
• Asynchronous electric motor



ADJUSTABLE
CUTTING DEPTH
AND CUTTING ANGLE 45°

| Art.No | gross weight | in cartoon | barcode |
|--------|--------------|------------|---------------|
| 059902 | 18.500 kg | 1 | 3800123162176 |

WOOD LATHE RD-WL03T

• [BG] Струг за дърво • [RO] Strung pentru. lemn • [SR] Glodalica za drvo • [MK] Струг за дрво • [RU] Токарный станок по дереву • [SL] Lesna stružnica • [EL] Ξύλουργικός τόρνος • [HR] Tokarilica za drvo
• [FR] Tour à bois • [IT] Tornio di legno • [ES] Tornilo de ligno • [PT] Torno p/ madeira

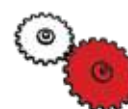
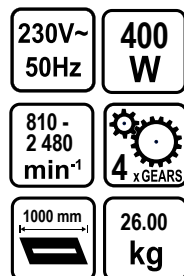

FOUR GEARS

| Art.No | gross weight | barcode |
|--------|--------------|---------------|
| 059905 | 24.000 kg | 3800123124952 |

SCROLL SAW RD-SS16J

• [BG] Мaшинa зa изрязване на орнаменти • [RO] Ferestrau de banc • [SR] Трачна testera • [MK] Мaшинa зa изрязување на украси • [RU] Выделитe пилa • [SL] Električna rezbarska žaga
• [EL] Πριονοκορδέλες • [HR] Stroj za rezanje ornamentima • [FR] Scie à chantourner • [IT] Scorri sega • [ES] Scroll vidis • [PT] Serra de rolagem

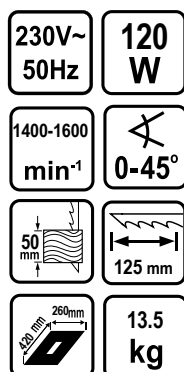

• Асинхронен електрически двигател
• Asynchronous electric motor



ADJUSTABLE
CUTTING DEPTH
AND CUTTING ANGLE 45°

| Art.No | gross weight | in cartoon | barcode |
|--------|--------------|------------|---------------|
| 059903 | 15.000 kg | | 3800123124945 |

TABLE SAW WITH EXTENSION WINGS AND STAND

• [BG] Циркулярен стационарен • [RO] Fierastrau circular de banc • [SR] Testera kružna stacionarna • [MK] Потезна-комбинирана пила • [RU] Настольная пила • [SL] Stabilna in kotna žaga
 • [EL] Δισκοπριονο • [HR] Stolna kružna pila • [FR] Scie à table avec rallonges et support • [IT] Sega da tavolo con ali di estensione e supporto • [ES] Tablo vidis per etendaj flugiloj kaj staras • [PT] Serra circular de bancada c/ abas extensíveis e suporte

RD-TS12B

| | |
|---------------------------|-------------------------------|
| 230V~ 50Hz | 2200 W |
| 4800 min ⁻¹ | ∅ [mm] 254x30mm 24T |
| 85 mm (max) | 555 mm 575 mm |
| 0-45° | DUST CAPTURE ПРАХО-УЛАВЯНЕ |
| 21.00 kg | COLOR BOX |

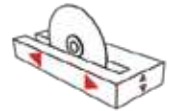

MAXIMUM DEPTH
740 mm



ADJUSTABLE CUTTING DEPTH AND CUTTING ANGLE 45°

| Art.No | gross weight | barcode |
|--------|--------------|---------------|
| 059403 | 25.600 kg | 3800123160738 |

RD-TS10

| | |
|---------------------------|-------------------------------|
| 230V~ 50Hz | 2000 W |
| 2950 min ⁻¹ | ∅ [mm] 315x30mm 36T |
| 90 mm (max) | 550 mm |
| 0-45° | DUST CAPTURE ПРАХО-УЛАВЯНЕ |
| 48.00 kg | COLOR BOX |

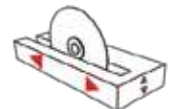

MAXIMUM DEPTH
900 mm



ADJUSTABLE CUTTING DEPTH AND CUTTING ANGLE 45°

| Art.No | gross weight | barcode |
|--------|--------------|---------------|
| 053105 | 52.000 kg | 3800123123207 |

COMBINED MITRE AND BENCH SAW RDP-TS11

• [BG] Циркулярен стационарен комбиниран • [RO] Fierastrau circular de banc • [SR] Testera kružna stacionarna • [MK] Потезна-комбинирана пила • [RU] Настольная пила • [SL] Stabilna in kotna žaga
 • [EL] Δισκοπριονο • [HR] Stolna kružna pila • [FR] Scie à onglet et banc combinée • [IT] Mitra e sega da banco combinate • [ES] Kombinita mitro kaj benko vidis • [PT] Serra de esquadria

| | |
|-------------------------------|----------------------|
| 230V~ 50Hz | 2200W |
| 3100 min ⁻¹ | ∅ [mm] 250x30x42T |
| 70 mm (max) | 45° |
| DUST CAPTURE ПРАХО-УЛАВЯНЕ | 38.25 kg |
| | COLOR BOX |



RAIDER®
Pro



BEVEL CUT
0-45°

| Art.No | gross weight | barcode |
|--------|--------------|---------------|
| 059401 | 42.500 kg | 3800123158988 |

ELECTRIC LOG CUTTING SAW RD-LS01

- [BG] Циркуляр за рязане на дърва • [RO] Circular cu suport pentru lemne foc • [SR] Testera Kružna Stacionarna • [MK] Пила за сечење на дрва • [RU] Дисковая пила для резки дерева • [SL] Krožna žaga za razrez lesa • [EL] Δισκοπριονα Κοπής Καυσόξυλων • [HR] Kružna pila za piljenje drva • [FR] Scie à bois électrique • [IT] Troncatrice elettrica per tronchi • [ES] Elektra registra kortego
- [PT] Serra de corte de toras elétrica

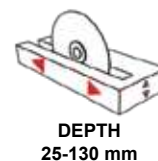
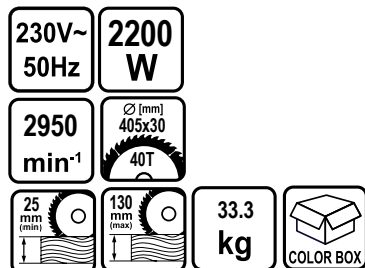

| Art.No | gross weight | in cartoon | barcode |
|--------|--------------|------------|---------------|
| 129940 | 37.000 kg | | 3800123168475 |

COMBINED WOODWORKING MACHINE RDP-CWM01

- [BG] Машина дървообработваща мултифункционална • [RO] Masina combinata pentru tamplarie • [SR] Kombinovana mašina za obradu drveta • [MK] Комбинирана машина за дрво
- [RU] Настольная пила • [SL] Stabilna in kotna žaga • [EL] Δισκοπριονο • [HR] Višenamjenski stroj za drvo • [FR] Machine à bois combinée • [IT] Macchina per la lavorazione del legno combinata
- [ES] Kombinita lignaj mašinoj • [PT] Máquina universal p/ carpintaria



Awarded with a gold medal

RAIDER®
Pro

CIRCULAR OPTION

PLANING OPTION



DRILL OPTION



Clamping device



Thickener

| Art.No | gross weight | in cartoon | barcode |
|--------|--------------|------------|---------------|
| 059402 | 108.500 kg | | 3800123158995 |

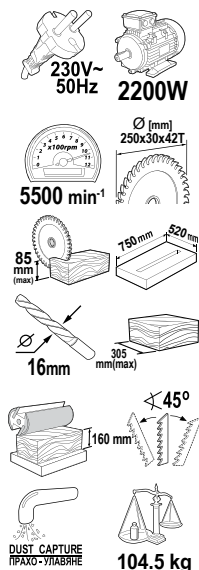

DUST COLLECTOR RD-DC01Q

- [BG] Прахоуловител • [RO] Aspirator de praf • [SR] Skupljač Prašine
- [MK] Правосмукалак • [RU] Пыле уловитель • [SL] Industrijski sesalnik
- [EL] Απορροφητήρας Σκονής • [HR] Usisavač za prašinu
- [FR] Collecteur de poussière • [IT] Aspirapolvere
- [ES] Polva kolektanto • [PT] Saco p/ lixadora de parede



- Асинхронен електрически двигател
- Asynchronous electric motor.



| Art.No | gross weight | barcode |
|--------|--------------|---------------|
| 059908 | 21.500 kg | 3800123123474 |

CUT OFF MACHINE

• [BG] Циркуляр за метал • [RO] Fierastru circular (metal) • [SR] Testera kružna za metal stacionarna • [MK] Циркулар за дрво степен • [RU] Торцовочная пила по метал • [SL] Rezalni brusilnik • [EL] Λεϊαντήρας κοπής • [HR] Rezna brusilica • [FR] Machine coupée • [IT] Tagliare la macchina • [ES] Tranču mašīn • [PT] Máquina cortada

RD-CM06

**NEW
PRODUCT**

| | |
|---|---|
| 230V~ 50Hz | 2000 W |
| 3700 min ⁻¹ | 355 mm |
| 25,4 mm | 17.800 kg |
|  |  |



CUT PRECISION





Ø 355 mm

| Art.No | gross weight | barcode |
|--------|--------------|---------------|
| 060106 | 18.500 kg | 3800123158650 |

RD-CM08

**NEW
PRODUCT**

| | |
|---|---|
| 230V~ 50Hz | 2400 W |
| 3700 min ⁻¹ | 355 mm |
| 25,4 mm | 16.950 kg |
|  |  |



CUT PRECISION



Ø 355 mm

| Art.No | barcode |
|--------|---------------|
| 060108 | 3800972016330 |

BENCH GRINDER

• [BG] Шмиргел • [RO] Polizor de banc • [SR] Štona Brusilica • [MK] Струг • [RU] Станок Точильный • [SL] Dvojni Brusilnik • [EL] Δίδυμοι τροχοί πάγκου • [HR] Dvostrana stolna brusilica • [FR] Meuleuse de table • [IT] Smerigliatrice da banco • [ES] Benka muelilo • [PT] Esmeriladora

RD-BG01

| | |
|---------------------------|---|
| 230V~ 50Hz | 150 W |
| 2950 min ⁻¹ | 12.7 mm 150mm |
| 4.320 kg |  |



ELECTROMAGNETIC
SWITCH



WHEEL
DRESSER

| Art.No | gross weight | barcode |
|--------|--------------|---------------|
| 061102 | 4.800 kg | 3800123124099 |

BENCH GRINDER

• [BG] Шмиргел • [RO] Polizor de banc • [SR] Stona Brusilica • [MK] Струг • [RU] Станок Точильный • [SL] Dvojni Brusilnik • [EL] Δίδυμο τροχοί πάγκου • [HR] Dvostrana stolna brusilica • [FR] Meuleuse de table • [IT] Smerigliatrice da banco • [ES] Benka muelilo • [PT] Esmeriladora

RDP-BG04

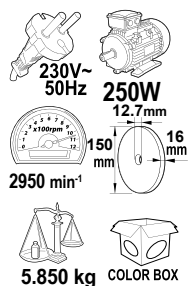
RAIDER®
Pro

ELECTROMAGNETIC SWITCH **WHEEL DRESSER**

| Art.No | gross weight | barcode |
|--------|--------------|---------------|
| 061101 | 6.500 kg | 3800123123825 |

RDP-BG02

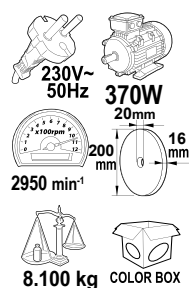

RAIDER®
Pro

ELECTROMAGNETIC SWITCH **WHEEL DRESSER**

| Art.No | gross weight | barcode |
|--------|--------------|---------------|
| 061103 | 9.000 kg | 3800123124204 |

BENCH GRINDER RDP-BG03

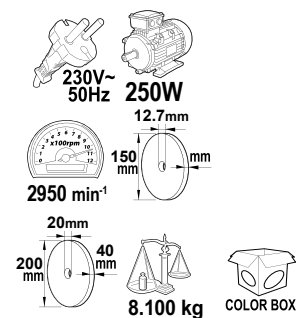
• [BG] Шмиргел редукторен • [RO] Polizor de banc • [SR] Stona Brusilica • [MK] Струг • [RU] Станок точильный • [SL] Dvojni brusilnik • [EL] Δίδυμο τροχοί πάγκου • [HR] Dvostrana stolna brusilica • [FR] Meuleuse de table • [IT] Smerigliatrice da banco • [ES] Benka muelilo • [PT] Esmeriladora



RAIDER®
Pro

ELECTROMAGNETIC SWITCH **WHEEL DRESSER**

| Art.No | gross weight | barcode |
|--------|--------------|---------------|
| 061104 | 9.000 kg | 3800123124273 |

BENCH GRINDER - SANDER RDP-BG05

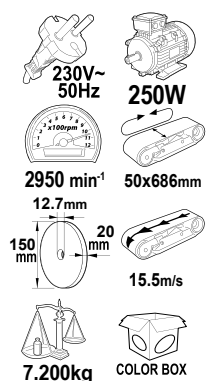
• [BG] Шмиргел с лентов шлайф • [RO] Polizor de banc - Slefuitor • [SR] Stona Brusilica • [MK] Струг • [RU] Станок Точильный • [SL] Dvojni brusilnik • [EL] Δίδυμο τροχοί πάγκου • [HR] Dvostrana stolna brusilica • [FR] Meuleuse d'établi - Ponceuse • [IT] Smerigliatrice da banco - levigatrice • [ES] Benka Muelillo - sander • [PT] Esmeriladora



RAIDER®
Pro

ELECTROMAGNETIC SWITCH **WHEEL DRESSER**

| Art.No | gross weight | barcode |
|--------|--------------|---------------|
| 061105 | 8.000 kg | 3800123123108 |

BENCH GRINDER WITH MINI GRINDER RD-BG06

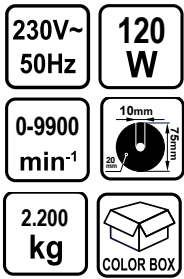
• [BG] Шлиргел с мини шлифовалка • [RO] Polizor de banc cu mini polizor drept • [SR] Stona brusilica sa brusilica beona • [MK] Струг и брусилка со осило • [RU] Станок точильный с мини шлифмашина
 • [SL] Dvojni brusilnik s mini brusilnik • [EL] Δίδυμοι τροχοί πτόγκου μίνι τροχέιο • [HR] Dvostrana stolna brusilica s ravna brusilica • [FR] Meuleuse de table avec mini meuleuse • [IT] Smerigliatrice da banco con mini smerigliatrice • [ES] Benka muelilo kun mini muelilo • [PT] Esmeriladora



| Art.No | gross weight | in cartoon | barcode |
|--------|--------------|------------|---------------|
| 129928 | 2.500 kg | 4 pcs | 3800123123450 |



POLISHER

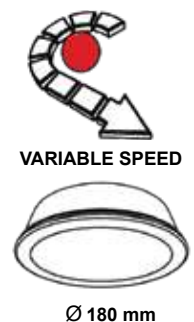
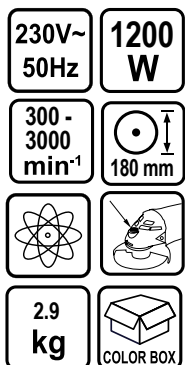

• [BG] Полирмашина • [RO] Masina de polishat • [SR] Polirka ugaona • [MK] Полирка • [RU] Электрический полировщик • [SL] Kotni polirni stroj • [EL] Γωνιακος Λειαντης • [HR] Brusilica za poliranje
 • [FR] Polisseuse • [IT] Lucidatrice • [ES] Elektra polisilo • [PT] Polidora

RD-PC04T



| Art.No | gross weight | in cartoon | barcode |
|--------|--------------|------------|---------------|
| 045102 | 3.260 kg | 2 pcs | 3800123124167 |

RD-PC03

| | |
|---------------------------|--|
| 230V~ 50Hz | 110 W |
| 3100 min ⁻¹ |  240 mm |
| 2.100 kg |  COLOR BOX |



Ø 240 mm

| Art.No | gross weight | in cartoon | barcode |
|--------|--------------|------------|---------------|
| 045101 | 2.650 kg | 4 pcs | 3800123124419 |

BURNISHING MACHINE RDP-BM01

• [BG] Шлайф ролков • [RO] Masina de polishat • [SR] Polirka • [MK] Полирка • [RU] Машина шлифовальная щеточная • [SL] Satinírka • [EL] Γωνιακός λειαντής • [HR] Brusilica za poliranje
• [FR] Satineuse Trinoxflex • [IT] Satinatrice • [ES] Satinadora • [PT] Polidora

**NEW
PRODUCT**

| Art.No | barcode |
|--------|---------------|
| 041601 | 3800972019676 |



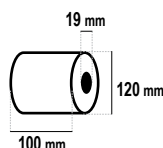

| | |
|---------------------------|--|
| 230V~ 50Hz | 2100 W |
| 3000 min ⁻¹ |  COLOR BOX |

POLISHING FLEECE WHEEL
middle grit ◆◆◆◆◆

| Art.No | barcode |
|--------|---------------|
| 155802 | 3800972019669 |

MINI GRINDER SET RD-MG07

• [BG] Шлифовалка права с 40 аксесоара • [RO] Mini polizor drept • [SR] Brusilica ceona 40 kom pribora • [MK] Рамна брусилка со додатоци • [RU] Мини шлифмашина • [SL] Mini brusilnik • [EL] Μίνι Τροχέιο • [HR] Ravna brusilica • [FR] Mini meuleuse set 40 accessoires • [IT] Mini grinder set 40 accessori • [ES] Mini-muellilo aro 40 akcesorajoj • [PT] Kit mini multifunções c/ 60 acessórios





| | |
|---|--|
| 230V~ 50Hz | 160 W |
| 5000- 35000 min ⁻¹ |  |
|  | 40 pcs  |
| 0.820 kg |  COLOR BOX |

VARIABLE SPEED

| Art.No | gross weight | in cartoon | barcode |
|--------|--------------|------------|---------------|
| 044105 | 1.020 kg | 10 pcs | 3800123166082 |

MINI GRINDER SET FLEXIBLE SHAFT RD-MG06D

• [BG] Шлифовалка права с жило 210 аксесоара • [RO] Mini polizor drept • [SR] Brusilica ceona 210 kom pribora • [MK] Рамна брусилка со додатоци • [RU] Мини шлифмашина • [SL] Mini brusilnik • [EL] Μίνι Τροχέιο • [HR] Ravna brusilica • [FR] Mini meuleuse set 210 accessoires • [IT] Mini grinder set 210 accessori • [ES] Mini-muellilo aro 210 akcesorajoj • [PT] Kit mini multifunções c/ 210 acessórios

| | |
|---|--|
| 230V~ 50Hz | 135 W |
| 10000- 32000 min ⁻¹ |  |
|  | 210 pcs  |
| 1.700 kg |  |

VARIABLE SPEED

| Art.No | gross weight | in cartoon | barcode |
|--------|--------------|------------|---------------|
| 044104 | 2.000 kg | 5 pcs | 3800123124242 |

MINI GRINDER SET FLEXIBLE SHAFT, TOOL HOLDER RD-MG09

• [BG] Шлифовалка права с жило 126 аксесоара • [RO] Mini polizor drept • [SR] Brusilica čelona 126 kom pribora • [MK] Рамна брусилка со додатоци • [RU] Мини шлифмашина • [SL] Mini brusilnik
• [EL] Μίνι Τροχέιο • [HR] Ravna brusilica • [FR] Mini meuleuse set 126 accessoires • [IT] Mini grinder set 126 accessori • [ES] Mini-muelillo aro 126 aksesorajoj • [PT] Kit mini multifunções c/ 126 acessórios

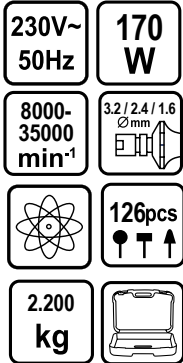

| Art.No | gross weight | in cartoon | barcode |
|--------|--------------|------------|---------------|
| 044107 | 2.760 kg | 6 pcs | 3800123170782 |

ENGRAVER RD-ENG01

• [BG] Уред за гравирание • [RO] Masina de gravat • [SR] Uredaj za graviranje • [MK] Апарат за гравирање • [RU] Машина для гравировки • [SL] Ročni gravirnik • [EL] Εργαλείο χαρακτικής • [HR] Alat za graviranje • [FR] Graveur • [IT] Incisore • [ES] Gravuristo • [PT] Gravadora

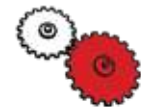
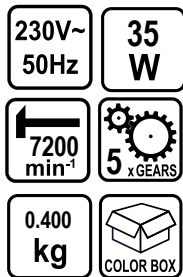

| Art.No | gross weight | in cartoon | barcode |
|--------|--------------|------------|---------------|
| 044108 | 0.500 kg | 20 pcs | 3800123172625 |

ELECTRIC SPRAY GUN

• [BG] Пистолет за боя • [RO] Pistol de vopsit • [SR] Pištolj za farbanje električni • [MK] Електричен пистол за фарбање • [RU] Краскопульт электрический • [SL] Električna razpršilna pištola • [EL] Πιστόλι βαφής ηλεκτρικό • [HR] Pištolj Za prskanje zidne boje • [FR] Pistolet électrique • [IT] Pistola a spruzzo elettrica • [ES] Elektra sprayilo • [PT] Pistola de pintura eléctrica

RDP-ESG11P

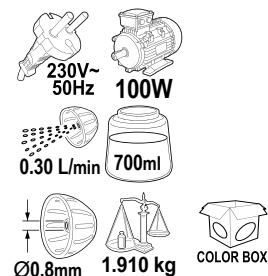
**RAIDER®
Pro**

DUSE DIAMETER
Ø 0.8 mm



CONTAINER CAPACITY
700 ml

| Art.No | gross weight | in carton | barcode |
|--------|--------------|-----------|---------------|
| 129952 | 2.120 kg | 4 pcs | 3800123127861 |

ELECTRIC SPRAY GUN WITH COMPRESSOR

• [BG] Пистолет за боя с ел. компресор • [RO] Pistol de vopsit cu compresor • [SR] Pištolj za farbanje sa kompresorom • [MK] Пистол за боја со компресор • [RU] Краскопульт с электрическим компрессором • [SL] lakirna pištola • [EL] Πιστόλι Βαφής ηλεκτρικό Κομπρεσοερ • [HR] Sustav Za Prskanje Boje • [FR] Pistolet de pulvérisation avec compresseur électrique • [IT] Pistola a spruzzo con compressore elettrico • [ES] Špruca pafilo per elektra kompresoro • [PT] Pistola de pintura com compressor elétrico

RD-SGC09



DUSE DIAMETER
Ø 1.5, 1.8, 2.2, 2.6 mm



CONTAINER CAPACITY
1000 ml

| Art.No | gross weight | in carton | barcode |
|--------|--------------|-----------|---------------|
| 074107 | 1.790 kg | | 3800972015166 |

RD-SGC06

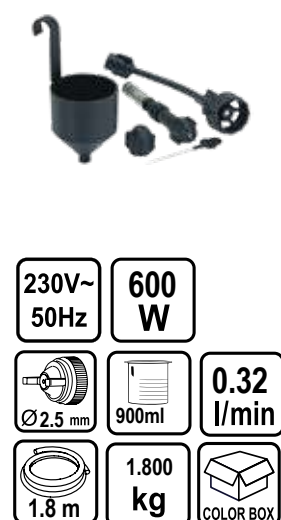

DUSE DIAMETER
Ø 2.5 mm



CONTAINER CAPACITY
9000 ml

| Art.No | gross weight | in carton | barcode |
|--------|--------------|-----------|---------------|
| 074105 | 3.220 kg | 4 pcs | 3800123167850 |

Strap for comfortable and easy carrying

RD-SGC04

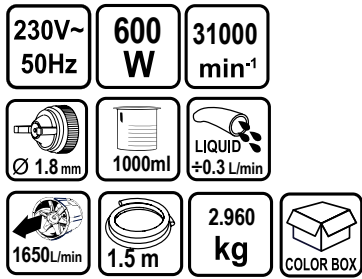

DUSE DIAMETER
Ø 1.8 mm



CONTAINER CAPACITY
1000 ml

| Art.No | gross weight | in cartoon | barcode |
|--------|--------------|------------|---------------|
| 074103 | 3.500 kg | 4 pcs | 3800123162206 |

RDP-SGC08

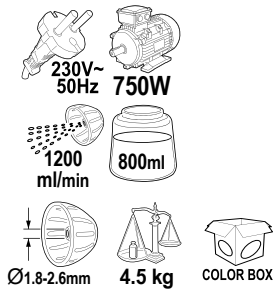

RAIDER®
Pro



DUSE DIAMETER
Ø 1.8-2.6 mm



CONTAINER CAPACITY
800 ml

| Art.No | gross weight | in cartoon | barcode |
|--------|--------------|------------|---------------|
| 074201 | 4.080 kg | 6 pcs | 3800123162206 |



HEAT GUN

• [BG] Пистолет за горещ въздух • [RO] Pistol cu aer cald • [SR] Pištoľ za vreli vazduh • [MK] Фен • [RU] Пистолет горячего воздуха • [SL] Vroca zracna pištoľa • [EL] Πιστολι φερμου αερα • [HR] Pištoľ za vrući zrak • [FR] Arbre à air chaud • [IT] Pistola aria calda • [ES] Pistola de aire caliente • [PT] Soprador de ar quente

RD-HG17





| | |
|---------------|---|
| 230V~ 50Hz | 2000 W |
| I-300l/min | I-350 °C |
| II-500l/min | II-550 °C |
| 0.790 kg |  COLOR BOX |



TEMPERATURE
ADJUSTMENT

| Art.No | gross weight | in cartoon | barcode |
|--------|--------------|------------|---------------|
| 074306 | 0.880 kg | 10 pcs | 3800972001862 |

RD-HG14

| | |
|--|---|
| 230V~ 50Hz | 2000 W |
| I-250l/min | I-250 °C |
| II-550l/min | II-550 °C |
| 5 pcs    | 0.9 kg |
| |  COLOR BOX |



TEMPERATURE
ADJUSTMENT

| Art.No | gross weight | in cartoon | barcode |
|--------|--------------|------------|---------------|
| 074302 | 1.000 kg | 10 pcs | 3800123162916 |

RD-HG18

| | |
|---------------|---|
| 230V~ 50Hz | 2000 W |
| I-240l/min | I-80-300 °C |
| II-480l/min | II-80-600 °C |
| 1.580 kg |  |



TEMPERATURE
ADJUSTMENT

| Art.No | gross weight | in cartoon | barcode |
|--------|--------------|------------|---------------|
| 074307 | 1.760 kg | 5 pcs | 3800972001954 |

RD-HG22

| | |
|---------------|---|
| 230V~ 50Hz | 2000 W |
| I-300l/min | I-350 °C |
| II-500l/min | II-550 °C |
| 0.800 kg |  |



TEMPERATURE
ADJUSTMENT

| Art.No | gross weight | in cartoon | barcode |
|--------|--------------|------------|---------------|
| 074311 | 1.660 kg | 10 pcs | 3800972002500 |

RD-HG12



| | |
|----------------|---|
| 230V~ 50Hz | 2000 W |
| I - 240 l/min | I - 80-300 °C |
| II - 480 l/min | II - 80-600 °C |
| 0.790 kg |  |



TEMPERATURE
ADJUSTMENT

| Art.No | gross weight | in carton | barcode |
|--------|--------------|-----------|---------------|
| 122105 | 2.000 kg | 5 pcs | 3800123143885 |

RD-HG23





| | |
|-----------------|--|
| 230V~ 50Hz | 2000 W |
| I - 300 l/min | I - 50°C |
| II - 300 l/min | II - 70 - 600°C |
| III - 500 l/min | III - 70 - 600°C |
| LCD DISPLAY | 5 pcs  |
| 1.490 kg |  |



TEMPERATURE
ADJUSTMENT

| Art.No | gross weight | in carton | barcode |
|--------|--------------|-----------|---------------|
| 074312 | 1.660 kg | 10 pcs | 3800972002517 |

RDP-HG21

| | |
|---|---|
|  230V~ 50Hz |  2000W |
| I - 350 l/min | I - 60°C |
| II - 350 l/min | II - 60 - 350°C |
| III - 500 l/min | III - 350 - 550°C |
| 5 pcs  | LCD DISPLAY |
|  1.22 kg |  COLOR BOX |







RAIDER®
Pro



TEMPERATURE
ADJUSTMENT

| Art.No | gross weight | in carton | barcode |
|--------|--------------|-----------|---------------|
| 074310 | 1.360 kg | 10 pcs | 3800972002494 |

RDP-HG16

| | |
|---|---|
|  230V~ 50Hz |  2000W |
| I - 120 - 550 l/min | I - 50°C |
| II - 120 - 550 l/min | II - 50 - 630°C |
| III - 550 l/min | III - 50 - 630°C |
| 5 pcs  | LCD DISPLAY |
|  1.89 kg |  COLOR BOX |



RAIDER®
Pro

LCD
DISPLAY



TEMPERATURE
ADJUSTMENT

| Art.No | gross weight | in carton | barcode |
|--------|--------------|-----------|---------------|
| 074305 | 2.110 kg | 6 pcs | 3800123166877 |

ELECTRIC WEED BURNER RD-HG20

• [BG] Пистолет за горещ въздух • [RO] Arzator electric de buruieni • [SR] Pištolj za vreli vazduh • [MK] Фен • [RU] Пистолет горячего воздуха • [SL] Vroca zracna pištola • [EL] Πιστολι φερμου αερα • [HR] Pištolj za vrući zrak • [FR] Arbre à air chaud • [IT] Pistola aria calda • [ES] Pistola de aire caliente • [PT] Ar quente

230V~
50Hz

2000
W

650°C

1.400
kg



| Art.No | gross weight | in cartoon | barcode |
|--------|--------------|------------|---------------|
| 074309 | 1.690 kg | 8 pcs | 3800972001978 |



PPR PIPE WELDING SET

• [BG] Пояльник за PP тръби 3 глави • [RO] Dispozitiv pentru lipit tevi PPR set • [SR] Pegla za plastične cevi • [MK] Греалка за пластични цевки • [RU] Паяльник для сварки пропиленовых труб • [SL] Spajkalnik polipropilena • [EL] Μηχάνημα συγκόλλησης πλαστικών • [HR] Aparat za varenje PPR cijevi • [FR] Fer à souder pour le soudage de tubes en propylène • [IT] Saldatore per saldatura di tubi in propilene • [ES] Solda ferro por veldi pipojn de propileno • [PT] Kit soldadora de PPR

RD-PW01

3 SOCKETS

230V~
50Hz

800
W

50-300
°C

Ø mm
20, 25,
32

3 pcs
⬆ ⬆ ⬆

3.395
kg



DIAMETER
Ø 20, 25, 32 mm

| Art.No | gross weight | in cartoon | barcode |
|--------|--------------|------------|---------------|
| 123103 | 4.170 kg | 6 pcs | 3800123123023 |

RD-PW02

6 SOCKETS

230V~
50Hz

1000
W

50-300
°C

Ø mm
20,25,32,40,
50,63

6 pcs
⬆ ⬆ ⬆

2.7
kg



DIAMETER
Ø 20, 25, 32, 40, 50, 63 mm

| Art.No | gross weight | in cartoon | barcode |
|--------|--------------|------------|---------------|
| 123104 | 3.000 kg | 6 pcs | 3800123123054 |

SOLDERING IRON SHARP TIP

• [BG] Поялник с остър връх • [RO] Letcon • [SR] Lemilica • [MK] Пиштол за лемене • [RU] Универсальный паяльник • [SL] Spajkalnik • [EL] Κολλητήρι • [HR] Lemilica Tanki Vrh • [FR] Fer à souder universel • [IT] Saldatore universale • [ES] Universala solderilo • [PT] Soldador



SHARP TIP

| art. № | W | weight kg | BARCODE |
|--------------------|----|-----------|---------------|
| 123107 RD-SI01J | 40 | 0.255 | 3800123143854 |
| 076401 RD-SI02J | 60 | 0.255 | 3800123159145 |
| 076402 RD-SI03J | 80 | 0.290 | 3800123159152 |



SOLDERING IRON FLAT TIP RD-SI04J

• [BG] Поялник плосък връх прав • [RO] Letcor • [SR] Lemilica • [MK] Пиштол за лемене • [RU] Универсальный паяльник • [SL] Spajkalnik • [EL] Κολλητήρι • [HR] Lemilica Tanki Vrh • [FR] Fer à souder universel • [IT] Saldatore universale • [ES] Universala solderilo • [PT] Soldador

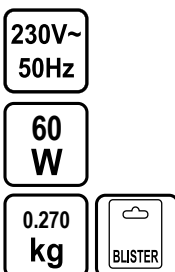

FLAT TIP

| Art.No | gross weight | in cartoon | barcode |
|--------|--------------|------------|---------------|
| 076403 | 0.260 kg | 50 pcs | 3800123159169 |

SOLDERING IRON FLAT BENT TIP RD-SI05J

• [BG] Поялник плосък връх извит • [RO] Letcon • [SR] Lemilica • [MK] Пиштол за лемене • [RU] Универсальный паяльник • [SL] Spajkalnik • [EL] Κολλητήρι • [HR] Lemilica Tanki Vrh • [FR] Fer à souder universel • [IT] Saldatore universale • [ES] Universala solderilo • [PT] Soldador

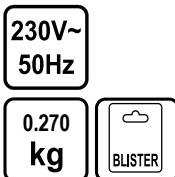

FLAT BENT TIP

| Art.No | gross weight | W | in cartoon | barcode |
|--------|--------------|-----|------------|---------------|
| 076404 | 0.270 kg | 60 | 50 pcs | 3800123159176 |
| 076409 | 0.270 kg | 100 | 50 pc | 3800972018907 |

SOLDERING IRON, TIN ABSORPTION PUMP, TIN KIT

• [BG] Поялник, Помпа за калай, Тинол паста к-т • [RO] Set lipire Letcon, Pompa, Fludor • [SR] Lemilica, Apsorcija pumpe, Pasta za lemljenje • [MK] Пиштол за лемене, Пумпа за калай, Паста за лемене к-т • [RU] Паяльник, Насос олова, Паяльная паста Набор • [SL] Spajkalnik, črpalka za kositer, Pasta za spajkanje Set • [EL] Κολλητήρι, Αποκόλλησης της αντλίας, πάστα συγκόλλησης • [HR] Lemilica, Pumpicu Za Odlemljivanje, pasta za lemljenje k-t • [FR] Fer à souder, pompe d'absorption d'étain, kit d'étain • [IT] Saldatore, pompa di assorbimento dello stagno, kit di stagno • [ES] Soldanta Fero, Stana Absorbado-Bombo, Stana llaro • [PT] Ferro de solda, Bomba de absorção de estanho, Kit de estanho

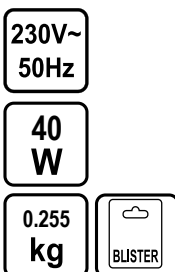

| Art.No | gross weight | in cartoon | barcode |
|--------|--------------|------------|---------------|
| 076406 | 0.400 kg | 30 pcs | 3800123166952 |

SOLDERING GUN

• [BG] Поялник индукционен • [RO] Pistol pentru lipit • [SR] Lemilica • [MK] Пиштол за лемење • [RU] Универсальный паяльник • [SL] Sprajkalnik • [EL] Κολλητήρι • [HR] Lemilica pištolj • [FR] Fer à souder universel • [IT] Pistola per saldatura • [ES] Soldanta pafilo • [PT] Pistola de soldar



LED

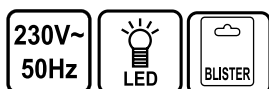

| art. № | W | weight kg | °C | BARCODE |
|--------------------|-----|-----------|-----|---------------|
| 076407 RD-SOG03 | 100 | 0.600 | 600 | 3800123166969 |
| 123105 RD-SOG02 | 175 | 0.720 | 600 | 3800123123818 |

SOLDERING IRON STATION RD-SISO1

• [BG] Станция за запояване • [RO] Stație de lipit • [SR] Stanica za lemljenje • [MK] Лемна станица • [RU] Паяльная станция • [SL] Sprajkalne postaje • [EL] Συγκόλληση σταθμό • [HR] Stanica za lemjenje • [FR] Station de soudure • [IT] Stazione di saldatura • [ES] Soldanta stacio • [PT] Estação de soldar

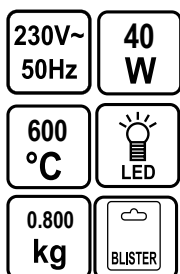

LED

| Art.No | gross weight | in cartoon | barcode |
|--------|--------------|------------|---------------|
| 076408 | 0.660 kg | 20 pcs | 3800123166976 |

TIN ABSORPTION PUMP

• [BG] Помпа за калай • [RO] Pompa absorbtie fluidor • [SR] Apsorpcija pumpe • [MK] Пумпа за калај • [RU] Насос олова • [SL] Črpalka za kositer • [EL] Αποκόλλησης της αντλίας • [HR] Pumpica za odlemljivanje • [FR] pompe d'absorption d'étain • [IT] Pompa di assorbimento di stagno • [ES] Stano absorción pumpilo • [PT] Bomba de absorção de estanho



| Art.No | gross weight | in cartoon | barcode |
|--------|--------------|------------|---------------|
| 076405 | 0.070 kg | 100 pcs | 3800123159183 |



HOT MELT GLUE GUN RD-GLG03

• [BG] Поялник за силикон • [RO] Pistol pentru lipit cu silicon • [SR] Pištolj za lepljenje • [MK] Пиштол за топло лепење • [RU] Пистолет клеевой электрический • [SL] Pištola za lepljenje • [EL] Κόλλα όπλο • [HR] Silikonski pištolj • [FR] Pistolet à colle électrique • [IT] Pistola per colla elettrica • [ES] Elektra glumpafilo • [PT] Aplicador de cola quente

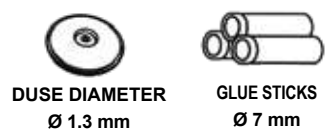

| Art.No | gross weight | in cartoon | barcode |
|--------|--------------|------------|---------------|
| 076201 | 0.240 kg | 48 pcs | 3800123162077 |

HOT MELT GLUE GUN RD-GLG06

• [BG] Поялник за силикон • [RO] Pistol pentru lipit cu silicon • [SR] Pištolj za lepljenje • [MK] Пиштол за топло лепење • [RU] Пистолет клеевой электрический • [SL] Pištola za lepljenje • [EL] Κόλλα όπλο • [HR] Silikonski pištolj • [FR] Pistolet à colle électrique • [IT] Pistola per colla elettrica • [ES] Elektra glumpafilo • [PT] Aplicador de cola quente

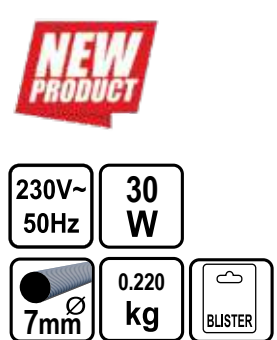

| Art.No | gross weight | barcode |
|--------|--------------|---------------|
| 076204 | 0.240 kg | 3800972012721 |

HOT MELT GLUE GUN RD-GLG04

• [BG] Поялник за силикон • [RO] Pistol pentru lipit cu silicon • [SR] Pištolj za lepljenje • [MK] Пиштол за топло лепење • [RU] Пистолет клеевой электрический • [SL] Pištola za lepljenje • [EL] Κόλλα όπλο • [HR] Silikonski pištolj • [FR] Pistolet à colle électrique • [IT] Pistola per colla elettrica • [ES] Elektra glumpafilo • [PT] Aplicador de cola quente

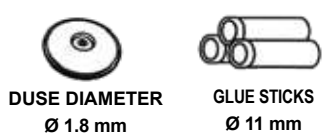
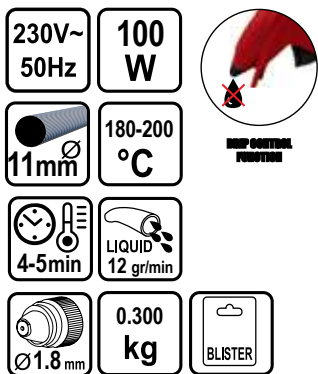

| Art.No | gross weight | in cartoon | barcode |
|--------|--------------|------------|---------------|
| 076202 | 0.380 kg | 24 pcs | 3800123162084 |

HOT MELT GLUE GUN RD-GLG07

• [BG] Поялник за силикон • [RO] Pistol pentru lipit cu silicon • [SR] Pištolj za lepljenje • [MK] Пиштол за топло лепење • [RU] Пистолет клеевой электрический • [SL] Pištola za lepljenje • [EL] Κόλλα όπλο • [HR] Silikonski pištolj • [FR] Pistolet à colle électrique • [IT] Pistola per colla elettrica • [ES] Elektra glumpafilo • [PT] Aplicador de cola quente



| Art.No | gross weight | in cartoon | barcode |
|--------|--------------|------------|---------------|
| 076205 | 0.360 kg | | 3800972012738 |

ELECTRIC HOIST

• [BG] Телфер електрически • [RO] Macara electrica • [SR] Dizalica električna • [MK] Електрична дигалка • [RU] Электрическая лебедка [SL] Električno vzvodno dvigalo • [EL] Ηλεκτρικά Βαρουλικά
• [HR] Dizalica konzolna električna • [FR] Palan électrique • [IT] Paranco elettrico • [ES] Elektra šaržilo • [PT] Guincho elétrico

RD-EH01
RD-EH02

 max LOAD with
PULLEY

 250 kg - Art. No. 121101
500 kg - Art. No. 121102

 max LOAD without
PULLEY

 125 kg - Art. No. 121101
250 kg - Art. No. 121102

**230V~
50Hz**

| art. № | W | M | Ø | max load with pulley | max load without pulley | BARCODE |
|-------------------|------|-------|-------|----------------------|-------------------------|---------------|
| 121101 RD-EH01 | 510 | 6-12m | 3.2mm | 250kg | 125kg | 3800123120169 |
| 121102 RD-EH02 | 1020 | 6-12m | 4.2mm | 500kg | 250kg | 3800123120084 |

RD-EH03
**230V~
50Hz**
**1600
W**
6-12 m
Ø5.7mm
**1000kg
max
LOAD**
**500kg
max
LOAD**
**29
kg**

WITH PULLEY

WITHOUT PULLEY



 max LOAD without
PULLEY
500 kg

 max LOAD with
PULLEY
1000 kg

| Art.No | gross weight | barcode |
|--------|--------------|---------------|
| 121103 | 32.390 kg | 3800123120091 |

RD-EH04
WITH MOVING VEHICLE
**230V~
50Hz**
**1600
W**
Ø 5.7mm
6-12 m
90 mm
**1000kg
max
LOAD**

WITHOUT PULLEY

WITH PULLEY

**500kg
max
LOAD**
**50
kg**

 max LOAD without
PULLEY
500 kg

 max LOAD with
PULLEY
1000 kg

| Art.No | gross weight | barcode |
|--------|--------------|---------------|
| 121104 | 55.800 kg | 3800123120244 |

ELECTRIC HOIST TROLLEY

• [BG] Электрическа количка за повдигане • [RO] Cârucior de ridicare electric • [SR] Električna kolica • [MK] Количка за електрична дигалка • [RU] Тележка электрической лебедка • [SL] Električni voziček za dvigalo • [EL] Ηλεκτρικό φορείο ανύψωσης • [HR] Kolica s električnim podizanjem • [FR] Chariot élévateur électrique • [IT] Carrello paranco elettrico • [ES] Elektra širmilo • [PT] Carrinho de elevação elétrico

**NEW
PRODUCT**

max LOAD

 500 kg - Art. No. 079201
1000 kg - Art. No. 079202

| art. № | W | capacity | max load | BARCODE |
|-------------------|-----|----------|----------|---------------|
| 079201 RD-EH05 | 60 | 13m/min | 0.5 T | 3800972016217 |
| 079202 RD-EH06 | 300 | 13m/min | 1 T | 3800972016224 |

CHAIN BLOCK

• [BG] Лебедка с верига • [RO] Scripete manual • [SR] Dizalica Lančana • [MK] Дигалка со ланец • [RU] Цепной блок • [SL] Vitel Ročni z verige • [EL] Χειροκίνητο βαρούλκο με αλυσίδα • [HR] Dizalica Lančana • [FR] Bloc chaîne • [IT] Blocco a catena • [ES] Ceno bloko • [PT] Bloqueio da cadeia



max LOAD
1000 kg - Art. No. 300401
2000 kg - Art. No. 300402
3000 kg - Art. No. 300403



| art. № | length | max load | weight | BARCODE |
|-------------------------------|--------|----------|--------|---------------|
| 300401 with one chain RD-CB01 | 3m | 1 T | 10 kg | 3800123120183 |
| 300402 RD-CB02 | 3m | 2 T | 12 kg | 3800123120206 |
| 300403 RD-CB03 | 3m | 3 T | 20 kg | 3800123120039 |



ARC WELDING MACHINE

• [BG] Електрожен • [RO] Aparat de sudura • [SR] Aparat za zavarivanje • [MK] Апарат за електролачно заварување • [RU] Сварочный аппарат • [SL] Varilni aparat • [EL] Ηλεκτροσυγκολλητής • [HR] Aparat Za Varenje • [FR] Machine de soudage à l'arc • [IT] Saldatrice ad arco • [ES] Arka veldmašino • [PT] Soldadora de arco

RD-WM17

230V~
50Hz

48
V

40-100
A

4.8
kVA

1.6-2.5mm

11
kg



| Art.No | gross weight | in cartoon | barcode |
|--------|--------------|------------|---------------|
| 077202 | 12.000 kg | | 3800123167218 |

RD-WM12

230V~
50Hz

48
V

60-180
A

9.6
kVA

2-4mm

19
kg



| Art.No | gross weight | in cartoon | barcode |
|--------|--------------|------------|---------------|
| 129942 | 21.000 kg | | 3800123120251 |

RD-WM13

| | |
|---------------|---------|
| 230V~ 50Hz | 48 V |
|---------------|---------|

| | |
|-------------|-------------|
| 60-200 A | 11.2 kVA |
|-------------|-------------|

| | |
|---|----------|
|  2-4mm | 20 kg |
|---|----------|

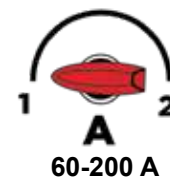

| Art.No | gross weight | barcode |
|--------|--------------|---------------|
| 129943 | 22.000 kg | 3800123120268 |

INVERTER WELDING MACHINE

• [BG] Инвертор • [RO] Aparat de sudura tip inverter • [SR] Aparat za zavarivanje • [MK] Инверторот • [RU] Сварочный аппарат • [SL] Varilni aparat • [EL] Ηλεκτροσυγκολλητής • [HR] Aparat za varenje inverter • [FR] Poste à souder à inverseur • [IT] Saldatrice ad inverter • [ES] Inversta veldmašino • [PT] Soldadora inverter

RD-IW160 E-LINE

| | |
|--------------------------|---------|
| 230V (400V) ~ 50Hz | 65 V |
|--------------------------|---------|

| | |
|-------------|------------|
| 20-120 A | 5.7 kVA |
|-------------|------------|

| | |
|---|-----------|
|  1.6-4mm | 3.7 kg |
|---|-----------|

-economy line-

| Art.No | gross weight | barcode |
|--------|--------------|---------------|
| 077209 | 3.900 kg | 3800972015623 |

RD-IW26

| | |
|--------------------------|---------|
| 230V (400V) ~ 50Hz | 65 V |
|--------------------------|---------|

| | |
|-------------|------------|
| 20-120 A | 5.7 kVA |
|-------------|------------|

| | |
|---|-------------|
|  1.6-3.2mm | 2.860 kg |
|---|-------------|



| Art.No | gross weight | in carton | barcode |
|--------|--------------|-----------|---------------|
| 077210 | 3.740 kg | 4 pcs | 3800972016248 |

RD-IW21

| | |
|--------------------------|---------|
| 230V (400V) ~ 50Hz | 65 V |
|--------------------------|---------|

| | |
|-------------|------------|
| 20-120 A | 6.1 kVA |
|-------------|------------|

| | |
|--|---------|
|  1.6-3.25mm | 3 kg |
|--|---------|



| Art.No | gross weight | in carton | barcode |
|--------|--------------|-----------|---------------|
| 077206 | 3.760 kg | 4 pcs | 3800972000216 |

INVERTER WELDING MACHINE

• [BG] Инвертор • [RO] Aparat de sudura tip inverter • [SR] Aparat za zavarivanje • [MK] Инверторот • [RU] Сварочный аппарат • [SL] Varilni aparat • [EL] Ηλεκτροσυγκολλητής • [HR] Aparat za varenje inverter • [FR] Poste à souder à invertisseur • [IT] Saldatrice ad inverter • [ES] Inversta veldmašino • [PT] Soldadora inverter

RD-IW 180 E-LINE

**NEW
PRODUCT**

230V~
50Hz

65
V

20-160
A

4.9
kVA

2-4mm

3.450
kg



-economy line-

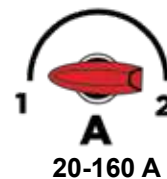

| Art.No | gross weight | in cartoon | barcode |
|--------|--------------|------------|---------------|
| 077213 | 5.300 kg | | 3800972016279 |

RD-IW25

**NEW
PRODUCT**

230V
(400V)
~ 50Hz

19
V

20-160
A

5.7
kVA

1.6-3.2mm

4.5
kg



| Art.No | gross weight | in cartoon | barcode |
|--------|--------------|------------|---------------|
| 077212 | 5.010 kg | 4 pcs | 3800972016262 |

RD-IW22

230V
(400V)
~ 50Hz

65
V

10-160
A

6.1
kVA

1.5-4mm

5.5
kg

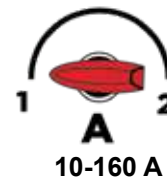

| Art.No | gross weight | in cartoon | barcode |
|--------|--------------|------------|--------------|
| 077207 | 6.120 kg | 4 pcs | 380097202265 |

RD-IW19

230V
(400V)
~ 50Hz

65
V

20-160
A

6.1
kVA

1.6 - 4.0mm

4
kg



| Art.No | gross weight | in cartoon | barcode |
|--------|--------------|------------|---------------|
| 077204 | 4.500 kg | 4 pcs | 3800123171826 |

RD-IW220 E-LINE

**NEW
PRODUCT**

230V~
50Hz

65
V

20-200
A

5.8
kVA

2-4mm

4.8
kg

COLOR BOX



-economy line-



20-200 A

| Art.No | gross weight | barcode |
|--------|--------------|---------------|
| 077214 | 5.500 kg | 3800972016286 |

RD-IW24

**NEW
PRODUCT**

230V
(400V)
~ 50Hz

62
V

20-200
A

5.7
kVA

1.6-4mm

5.4
kg

COLOR BOX



20-200 A

| Art.No | gross weight | in cartoon | barcode |
|--------|--------------|------------|---------------|
| 077211 | 6.000 kg | 2 pcs | 3800972016255 |

RD-IW20

230V
(400V)
~ 50Hz

62
V

20-200
A

7.8
kVA

1.6-4mm

5.400
kg

COLOR BOX



20-200 A

| Art.No | gross weight | in cartoon | barcode |
|--------|--------------|------------|---------------|
| 077205 | 6.080 kg | 4 pcs | 3800123171833 |

RDP-IW15



10-200
A

56
V

7
kVA

Ø1.6-5mm

8.200 kg

COLOR BOX



**RAIDER®
Pro**



10-200 A

| Art.No | gross weight | in cartoon | barcode |
|--------|--------------|------------|---------------|
| 123302 | 9.000 kg | | 3800123135212 |

INVERTER WELDING MACHINE FOR GENERATOR RDP-IW23

• [BG] Инверторен заваръчен апарат за генератор • [RO] Aparat de sudura • [SR] Aparat za zavaravanje • [MK] Инвертор • [RU] Инверторный сварочный аппарат для генератора • [SL] Inverter varilni stroj za generator • [EL] Μηχανή συγκόλλησης αντιστροφής για γεννήτρια • [HR] Inverter aparat za zavarivanje generatora • [FR] Poste à souder à inverseur pour générateur • [IT] Saldatrice ad inverter per generatore • [ES] Kontrolni soldatšinson por generatore • [PT] Soldadora inverter



62
V

230V~
50Hz
20-200
A

7.8
kVA



Ø1.8-4mm



3.700 kg



COLOR BOX



RAIDER®
Pro

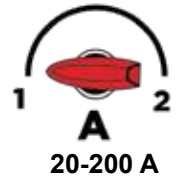

20-200 A

| Art.No | gross weight | in cartoon | barcode |
|--------|--------------|------------|---------------|
| 077208 | 4.900 kg | 2 pcs | 3800972004207 |

MIG/MAG WELDING MACHINE RD-MW11

• [BG] Теплоподаващо устройство • [RO] MIG/MAG Aparat de sudura • [SR] Aparat za zavarivanje MIG/MAG • [MK] MIG/MAG заварувачки уред • [RU] Сварочный полуавтомат • [SL] Varilni aparat mig/mag • [EL] Ηλεκτροσυγκολλητής • [HR] Aparat za varenje sa žicom • [HR] Aparat za varenje inverter • [FR] Machine à souder Mig / Mag • [IT] Dispositivo semiautomatico di saldatura automatica • [ES] Automata veldado kun duobla aparato • [PT] Dispositivo automático de soldagem semiautomática

230V~
50Hz

35
V

WELDING TORCH (INCLUDED)

6.2
kVA

30-135
A



0.6-1mm

26.000
kg



COLOR BOX

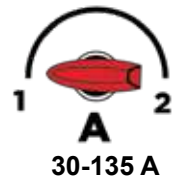

30-135 A

| Art.No | gross weight | in cartoon | barcode |
|--------|--------------|------------|---------------|
| 129961 | 26.500 kg | | 3800123152146 |



WELDING HELMET AUTO-DARKENING

• [BG] Шлем заваръчен фотосопапен • [RO] Masca de sudura • [SR] Maska za zavarivanje automatik • [MK] Самозатемнувачка кацига за заварување • [RU] Сварочный шлем • [SL] Avtomatska čelada za varjenje [EL] Κίνα Αυτόματη συγκόλλησης κρόνος • [HR] Maska za Zavarivanje fotosjetljiva automatska solarna • [FR] Casque de soudage • [IT] Casco per saldatura • [ES] Solda kasko • [PT] Capacete de soldar c/ escurecimento automático

RD-WHO1

2PCS
PROTECTIVE LENS
FREE OF CHARGE

DIN 8/10/12



- Optical class: 1/1/1/2
- Filter dimension: 110×90×9mm
- View size: 92×42mm
- Light state shade: DIN 4
- Dark state shade: DIN8/10/12, can be selected
- Switching time from Light to Dark: 1/25000 sec
- Sensitivity control: Low or high can be selected
- Delay time from Dark to Light: 0.2-0.5 sec.
- Arc sensors: 1

- TIG range: ≥ 35 amps/DC; ≥ 15 amps/AC
- UV/IR protection: Up to DIN 16 At all time
- Powered supply: Solar Cells + Sealed Lithium battery
- Power on/off: Full automatic
- Operate temp: -10°C + 55°C
- Storing temp: -20°C + 70°C
- Material: PP
- Approval: CE EN175 EN379
- N.W.: 445g



SOLAR CELLS

| Art.No | gross weight | in cartoon | barcode |
|--------|--------------|------------|---------------|
| 138301 | 0.270 kg | 6 pcs | 3800123174278 |

RD-WHO2

2PCS
PROTECTIVE LENS
FREE OF CHARGE

DIN 9-13



- Optical class: 1/1/1/2
- Filter dimension: 110×90×9mm
- View size: 92×42mm
- Light state shade: DIN 4
- Dark state shade: DIN 9-13, Stepless adjusted
- Switching time from Light to Dark: 1/25000sec
- Sensitivity control: Adjustable from Low to high
- Delay time from Dark to Light: Adjustable from 0.2 sec. (fast) to 1.0 sec. (slow)
- Arc sensors: 2

- TIG range: ≥ 35 amps/DC; ≥ 15 amps/AC
- GRINDING function: Yes
- UV/IR protection: Up to DIN 16 At all time
- Powered supply: Solar Cells + Sealed Lithium battery
- Power on/off: Full automatic
- Operate temp: -10°C + 55°C
- Storing temp: -20°C + 70°C
- Material: PP
- Approval: CE EN175 EN379
- N.W.: 465g



SOLAR CELLS

| Art.No | gross weight | in cartoon | barcode |
|--------|--------------|------------|---------------|
| 138302 | 0.270 kg | 6 pcs | 3800123174285 |

RD-WHO3

BG DESIGN
DIN 9-13



- Optical class: 1/1/1/2
- Filter dimension: 110×90×9mm
- View size: 92×42mm
- Light state shade: DIN 4
- Dark state shade: DIN 9-13, Stepless adjusted
- Switching time from Light to Daark: 1/25000sec
- Sensitivity control: Adjustable from Low to high
- Delay time from Dark to Light: Adjustable from 0.2 sec. (fast) to 1.0 sec. (slow)
- Arc sensors: 2

- TIG range: ≥ 35 amps/DC; ≥ 15 amps/AC
- GRINDING function: Yes
- UV/IR protection: Up to DIN 16 At all time
- Powered supply: Solar Cells + Sealed Lithium battery
- Power on/off: Full automatic
- Operate temp: -10°C + 55°C
- Storing temp: -20°C + 70°C
- Material: PP
- Approval: CE EN175 EN379
- N.W.: 465g



SOLAR CELLS

| Art.No | gross weight | in cartoon | barcode |
|--------|--------------|------------|---------------|
| 138307 | 0.270 kg | 6 pcs | 3800972004405 |

RD-WHO4

RO DESIGN
DIN 9-13



- Optical class: 1/1/1/2
- Filter dimension: 110×90×9mm
- View size: 92×42mm
- Light state shade: DIN 4
- Dark state shade: DIN 9-13, Stepless adjusted
- Switching time from Light to Dark: 1/25000sec
- Sensitivity control: Adjustable from Low to high
- Delay time from Dark to Light: Adjustable from 0.2 sec. (fast) to 1.0 sec. (slow)
- Arc sensors: 2

- TIG range: ≥ 35 amps/DC; ≥ 15 amps/AC
- GRINDING function: Yes
- UV/IR protection: Up to DIN 16 At all time
- Powered supply: Solar Cells + Sealed Lithium battery
- Power on/off: Full automatic
- Operate temp: -10°C + 55°C
- Storing temp: -20°C + 70°C
- Material: PP
- Approval: CE EN175 EN379
- N.W.: 465g



SOLAR CELLS

| Art.No | gross weight | in cartoon | barcode |
|--------|--------------|------------|---------------|
| 138309 | 0.270 kg | 6 pcs | 3800972010260 |

WELDING FILTER WITH SOLAR CELLS FOR WELDING HELMET

[BG] Филтър за заваръчен шлем RAIDER • [RO] Filtru pentru masca de sudura • [SR] Filter za maska za zavarivanje automatik • [MK] Филтер за самозатемнувачка кацига за заварување • [RU] Фильтр для сварочный шлем • [SL] Filter za avtomatska čelada za varjenje • [EL] Φίλτρο ΚίναΑυτόματη συγκόλλησης κράνος • [HR] Filter za kaciga za zavarivanje • [FR] Filtre de soudage avec cellules solaires • [IT] Filtro per saldatura con celle solari per casco di saldatura • [ES] Soldada Filtro Kun Sunaj Čelaj Por Soldado-Kasko • [PT] Filtro de soldagem com células solares para capacete de soldagem

DIN 9-13

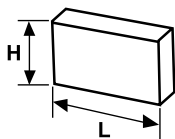

| | |
|----------|----------|
| H | L |
| 90mm | 110mm |



| Art.No | gross weight | in cartoon | barcode |
|--------|--------------|------------|---------------|
| 138305 | 0.130 kg | 50 pcs | 3800123174315 |

FRONT PROTECTIVE LENS FOR WELDING HELMET 5 PCS.

[BG] Екран външен предпазен за шлем RAIDER • [RO] Lentila frontala de protectie pentru masca de sudura • [SR] Prednje zaštitno staklo za maska za zavarivanje automatik • [MK] Предно заштитно стакло за самозатемнувачка кацига за заварување • [RU] Передний защитное стекло для сварочный шлем • [SL] Sprednja zaščitna stekla za avtomatska čelada za varjenje • [EL] Εμπρός προστατευτικό γυαλί ΚίναΑυτόματη συγκόλλησης κράνος • [HR] Prednja zaštitna stakla za kaciga za zavarivanje • [FR] Lentille de protection avant pour casque de soudeur • [IT] Lente protettiva frontale per casco di saldatura • [ES] Antaüa protekta lenso por veldi kaskon • [PT] Lente de protecção frontal para capacete de soldagem

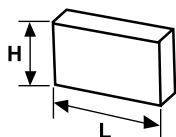

| art. № | L | H | barcode |
|-----------------------|-----|-----|---------------|
| 138303 for RD-WH01 | 113 | 89 | 3800123174292 |
| 138306 for RD-WH02 | 3m | 2 T | 3800123174322 |

INSIDE PROTECTIVE LENS FOR WELDING HELMET 5 PCS.

[BG] Екран вътрешен предпазен за шлем RAIDER • [RO] Lentila interna de protectie pentru masca de sudura • [SR] Interni zaštitno staklo za maska za zavarivanje automatik • [MK] Внатрешно заштитно стакло за самозатемнувачка кацига за заварување • [RU] Внутреннее защитное стекло для сварочный шлем • [SL] Notranji zaščitna stekla za avtomatska čelada za varjenje • [EL] Εσωτερικός προστατευτικό γυαλί ΚίναΑυτόματη συγκόλλησης κράνος • [HR] Interno zaštitno staklo za kaciga za zavarivanje • [FR] Lentille de protection intérieure pour casque de soudage • [IT] Lente protettiva interna per casco per saldatura • [ES] Ene de protekta lenso Por Soldado-Kasko • [PT] Lente protetora interna para capacete de soldagem

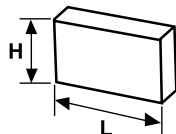

| | |
|----------|----------|
| H | L |
| 46.4mm | 100.4mm |

| Art.No | gross weight | in cartoon | barcode |
|--------|--------------|------------|---------------|
| 138304 | 0.010 kg | 400 pcs | 3800123174308 |

INVERTER BATTERY CHARGER RD-BC 13

[BG] Зарядно за акумулатор инверторно • [RO] Redresor auto digital • [SR] Punjač akumulatora • [MK] Полнач за акумулатор • [RU] Зарядное устройство инвертор для аккумуляторов • [SL] Polniliec baterij • [EL] Φορτιστής μπαταριών • [HR] Inverter baterijski punjač • [FR] Chargeur de batterie inverter • [IT] Carica batterie inverter • [ES] Insura batteria kargero • [PT] Carregador de bateria do invisor



- Battery charge level indicator
 - Charges automobile batteries up to 120 Ah
 - Automatically switches off when the full battery charge is reached
 - 8 programs
 - Can be used to support boat accumulators, jets, etc. machines that are not used in the winter
 - Charges both classic lead acid batteries and the latest WET MF, GEL, AGM, Ca-Ca batteries. This charger can also revive a very exhausted battery.
- The following protections are built in:
1. overload protection;
 2. protection against polarity reversal;
 3. short-circuit protection of the terminals;
- Degree of protection IP 65 for outdoor use

| | |
|---------------|---|
| 230V~ 50Hz | 6/12 V |
| 4 A | 120 Ah |
| 0.550 kg |  |

| Art.No | gross weight | in cartoon | barcode |
|--------|--------------|------------|---------------|
| 032202 | 0.700 kg | 4 pcs | 3800972002951 |

BATTERY CHARGER

[BG] Зарядно за акумулатор • [RO] Incarcator acumulator • [SR] Punjač akumulatora • [MK] Полнач за акумулатор • [RU] Зарядное устройство для аккумуляторов • [SL] Polnilca Za Baterije • [EL] Φορτιστής Μπαταριών • [HR] Punjač Akumulatora • [FR] Chargeur de batterie • [IT] Caricabatterie • [ES] Šargilo • [PT] Carregador de bateria

RD-BC05

| | |
|---------------|-------------|
| 230V~ 50Hz | 6/12 V |
| 75 W | 5 A |
| 20-75 Ah | 3.340 kg |

COLOR BOX

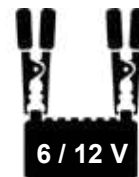

| Art.No | gross weight | in cartoon | barcode |
|--------|--------------|------------|---------------|
| 032201 | 3.700 kg | 4 pcs | 3800123162299 |

RD-BC10

| | |
|---------------|-------------|
| 230V~ 50Hz | 12 V |
| 85 W | 5 A |
| 20-60 Ah | 3.600 kg |

COLOR BOX

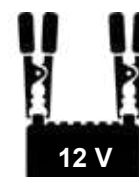

| Art.No | gross weight | in cartoon | barcode |
|--------|--------------|------------|---------------|
| 129962 | 4.120 kg | 4 pcs | 3800123152153 |

RD-BC11

| | |
|---------------|-------------|
| 230V~ 50Hz | 12/24 V |
| 110 W | 9 A |
| 25-135 Ah | 4.165 kg |

COLOR BOX

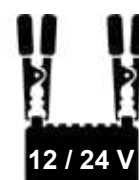

| Art.No | gross weight | in cartoon | barcode |
|--------|--------------|------------|---------------|
| 129963 | 4.700 kg | 4 pcs | 3800123152160 |

RD-BC12

| | |
|---------------|-------------|
| 230V~ 50Hz | 12/24 V |
| 310 W | 14 A |
| 92-210 Ah | 7.740 kg |

COLOR BOX



| Art.No | gross weight | in cartoon | barcode |
|--------|--------------|------------|---------------|
| 129964 | 8.620 kg | 4 pcs | 3800123152177 |

GASOLINE GENERATOR RD-GG08

[BG] Генератор за ток бензинов двутактов • [RO] Generator benzina • [SR] Benzinski generator • [MK] Генератор на струја • [RU] Мощность генератора • [SL] Generator moči • [EL] Ισχύ γεννήτριας • [HR] Dizalica konzolna električna • [FR] Générateur d'essence deux temps • [IT] Generatore di benzina a due tempi • [ES] Benzina generatore du batoj • [PT] Gerador a gasolina dois cursos

Бенз. двигател: Едноцилиндров, двутактов с въздушно охлаждане.
Gasoline engine: One cylinder, 2 stroke with air cooling.

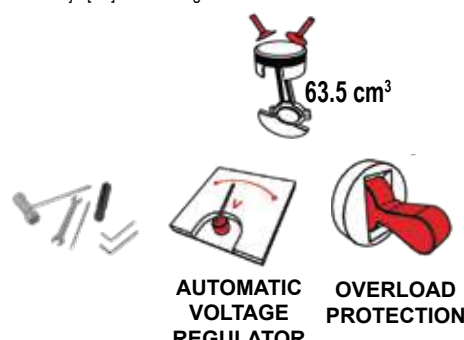
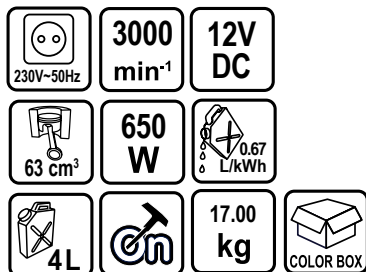

| Art.No | gross weight | in cartoon | barcode |
|--------|--------------|------------|---------------|
| 090106 | 17.000 kg | 1 pcs | 3800972010659 |

GASOLINE GENERATOR INVERTOR

[BG] Генератор за ток бензинов инверторен • [RO] Generator benzina invertor • [SR] Benzinski generator invertor • [MK] Генератор на струја инвертер • [RU] Генератор мощность инвертор • [SL] Generator moči invertor • [EL] Ισχύ γεννήτριας αντιστροφείας • [HR] Dizalica konzolna električnainvertor • [FR] Générateur à essence inverseur • [IT] Inverter del generatore di benzina • [ES] Generador de benzino • [PT] Inversor gerador a gasolina

Бенз. двигател: Едноцилиндров, четиритактов с въздушно охлаждане.
Gasoline engine: One cylinder, 4 stroke with air cooling.

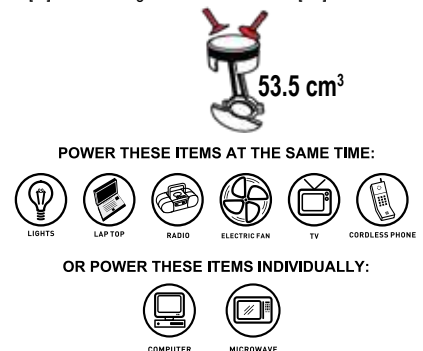
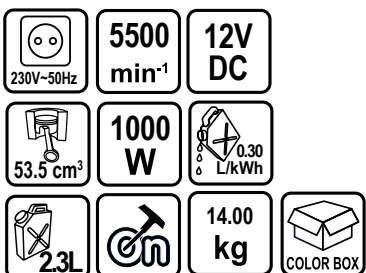

| Art.No | gross weight | in cartoon | barcode |
|--------|--------------|------------|---------------|
| 090102 | 16.000 kg | 1 pcs | 3800972000476 |

RD-GG10

Бенз. двигател: Едноцилиндров, четиритактов с въздушно охлаждане.
Gasoline engine: One cylinder, 4 stroke with air cooling.

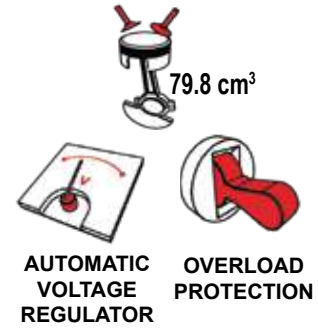
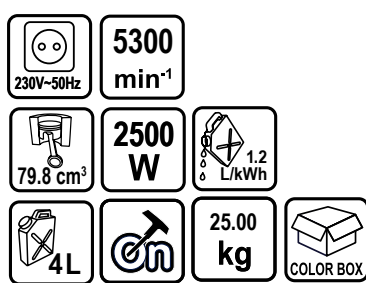

| Art.No | gross weight | in cartoon | barcode |
|--------|--------------|------------|---------------|
| 090105 | 25.000 kg | 1 pcs | 3800972010666 |

GASOLINE GENERATOR

[BG] Генератор за ток бензинов • [RO] Generator benzina • [SR] Benzinski generator • [MK] Генератор на струја • [RU] Мощность генератора • [SL] Generator moči • [EL] Ισχύ γεννήτριας • [HR] Dizalica konzolna električna • [FR] Générateur d'essence • [IT] Generatore di benzina • [ES] Benzina generatore • [PT] Gerador a gasolina

Бенз. Двигател: Едноцилиндров, четиритактов с въздушно охлаждане.
Gasoline Engine: One cylinder, 4 stroke with air cooling.

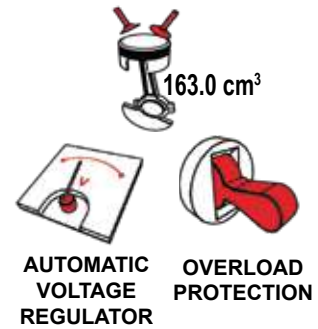
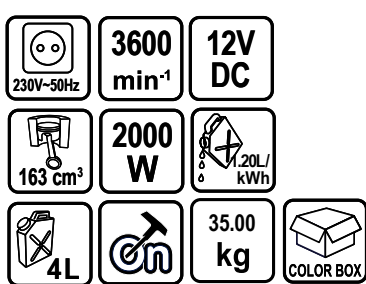

| Art.No | gross weight | in cartoon | barcode |
|--------|--------------|------------|---------------|
| 129931 | 39.000 kg | 1 pcs | 3800123145056 |

ACCESSORIES PNEUMATICS RAIDER MACHINES R20 SYSTEM

RD-GG06

Бенз. Двигател: Едноцилиндров, четиритактов с въздушно охлаждане.
Gasoline Engine: One cylinder, 4 stroke with air cooling.



| | | |
|---------------------|----------------------------------|------------------|
| 230V-50Hz | 3600 min ⁻¹ | 12V DC |
| 208 cm ³ | 2800 W | 0.32L/kWh |
| 15L | | 39 kg |
| COLOR BOX | | |

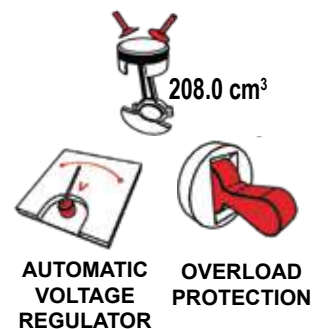

| Art.No | gross weight | in cartoon | barcode |
|--------|--------------|------------|---------------|
| 090103 | 44.000 kg | 1 pcs | 3800972000483 |

RD-GG04

Бенз. Двигател: Едноцилиндров, четиритактов с въздушно охлаждане.
Gasoline Engine: One cylinder, 4 stroke with air cooling.



| | | |
|---------------------|----------------------------------|------------------|
| 230V-50Hz | 3600 min ⁻¹ | 12V DC |
| 163 cm ³ | 2800 W | 0.32L/kWh |
| 15L | | 35 kg |
| COLOR BOX | | |

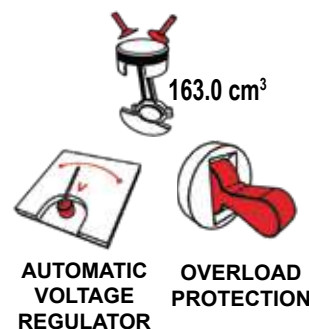

| Art.No | gross weight | in cartoon | barcode |
|--------|--------------|------------|---------------|
| 090101 | 38 | 1 pcs | 3800123169830 |

RD-GG03

Бенз. Двигател: Едноцилиндров, четиритактов с въздушно охлаждане.
Gasoline Engine: One cylinder, 4 stroke with air cooling.



| | | |
|---------------------|----------------------------------|--------------------|
| 230V-50Hz | 3600 min ⁻¹ | 12V DC |
| 389 cm ³ | 5000 W | 0.325L/kWh |
| 25L | | 87.00 kg |
| COLOR BOX | | |

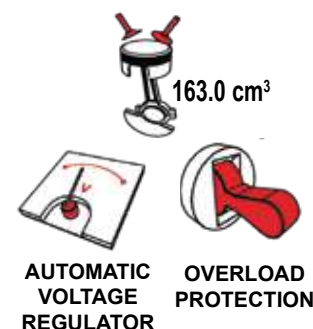

| Art.No | gross weight | in cartoon | barcode |
|--------|--------------|------------|---------------|
| 129941 | 83.000 kg | 1 pcs | 3800123120213 |

RD-GG07

Бенз. Двигател: Едноцилиндров, четиритактов с въздушно охлаждане.
Gasoline Engine: One cylinder, 4 stroke with air cooling.

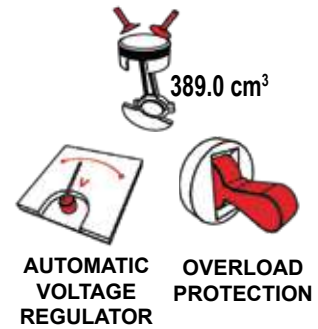
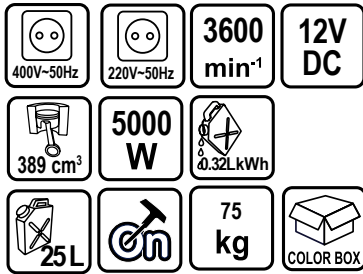

| Art.No | gross weight | in cartoon | barcode |
|--------|--------------|------------|---------------|
| 090104 | 84.000 kg | | 3800972000490 |



ELECTRIC WINCH

• [BG] Автолебедка • [RO] Troliu electric • [SR] Električno vitlo • [MK] Електрично витло [RU] Электрическая лебедка грузовик • [SL] Električni vitel • [EL] Αυτόματη ηλεκτρικά βαρούλκο • [HR] Električna dizalica • [HR] Dizalica konzolna električna • [FR] Treuil électrique • [IT] Verricello elettrico [ES] Elektra turbo • [PT] Guincho elétrico

RD-EW05

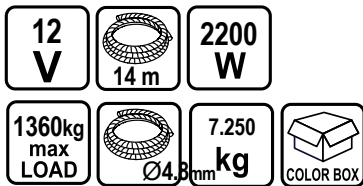

max LOAD
1360 kg

| Art.No | gross weight | in cartoon | barcode |
|--------|--------------|------------|---------------|
| 121605 | 9.430 kg | | 3800123120077 |

RD-EW06

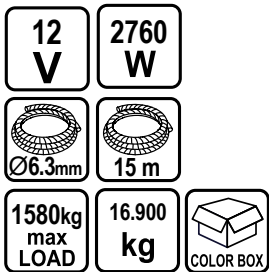

max LOAD
1580 kg

| Art.No | gross weight | in cartoon | barcode |
|--------|--------------|------------|---------------|
| 121606 | 18.560 kg | | 3800123120114 |

RD-EW07

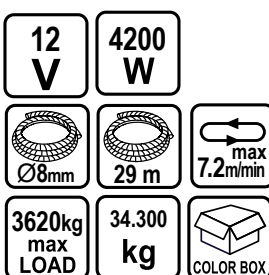

max LOAD
3620 kg

| Art.No | gross weight | in cartoon | barcode |
|--------|--------------|------------|---------------|
| 121608 | 35.800 kg | | 3800123119934 |

HYDRAULIC BOTTLE JACK

• [BG] Крик хидравличен тип "бутилка" • [RO] Cric hidraulic • [SR] Hidrauličnu dizalicu tip "flaša" • [MK] Хидраулична дигалка • [RU] Гидравлическая бутылка • [SL] Hidravlična dvigalka • [EL] Γρύλος αυτοκινήτου • [HR] Hidraulična dizalica • [FR] Bouteille hydraulique • [IT] Presa per bottiglia idraulica • [ES] Hidraülka botela fanto • [PT] Macaco hidraulico

| Art. № | Model | Load (tone) | WEIGHT KG | min H mm | max H mm | max H mm | max H mm | Barcode |
|--------|---------|-------------|-----------|----------|----------|----------|----------|---------------|
| 300101 | RD-HB02 | 2 | 2.2 | 148 | 278 | 80 | 50 | 3800123136016 |
| 300102 | RD-HB03 | 3 | 3 | 180 | 340 | 110 | 50 | 3800123136023 |
| 300103 | RD-HB04 | 4 | 3 | 180 | 340 | 110 | 50 | 3800123136030 |
| 300104 | RD-HB05 | 5 | 4 | 185 | 355 | 110 | 60 | 3800123136047 |
| 300106 | RD-HB10 | 10 | 5.4 | 200 | 385 | 125 | 60 | 3800123136061 |
| 300108 | RD-HB15 | 15 | 7.5 | 255 | 425 | 140 | 60 | 3800123136085 |
| 300109 | RD-HB20 | 20 | 9.9 | 235 | 440 | 145 | 60 | 3800123136092 |
| 300110 | RD-HB32 | 32 | 13 | 255 | 405 | 150 | | 3800123136108 |
| 300111 | RD-HB50 | 50 | 21 | 255 | 405 | 150 | | 3800123136115 |



HYDRAULIC BOTTLE JACK RD-HB20L

• [BG] Крик хидравличен нископрофилен тип "бутилка" • [RO] Cric hidraulic • [SR] Hidrauličnu dizalicu tip "flaša" • [MK] Хидраулична дигалка • [RU] Гидравлическая бутылка • [SL] Hidravlična dvigalka • [EL] Γρύλος αυτοκινήτου • [HR] Hidraulična dizalica • [FR] Cric bouteille hydraulique profil bas • [IT] Tappo idraulico della bottiglia a basso profilo • [ES] Hidraülka sako butono malalta profilo • [PT] Macaco hidraulico

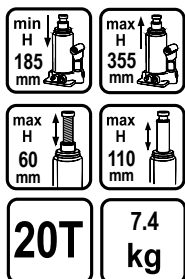

| Art.No | gross weight | in cartoon | barcode |
|--------|--------------|------------|---------------|
| 300112 | 7.680 kg | 2 pcs | 3800123173974 |

TROLLEY JACK

• [BG] Крик хидравличен тип "Крокодил" • [RO] Cric crocodil • [SR] Dizalica hidraulična krokodilka • [MK] Хидраулична крокодил дигалка • [RU] Гидравлический автомобильный домкрат • [SL] Hidravlična dvigalka na kolesih • [EL] Γρύλος Τρέιλερ αυτοκινήτου • [HR] Hidraulična dizalica • [FR] Vérin hydraulique • [IT] Presa auto idraulica • [ES] Hidraülka automóvil • [PT] Tomada do carro hidráulico



| Art. № | Model | Load (tone) | WEIGHT KG | min H mm | max H mm | Barcode |
|--------|---------|-------------|-----------|----------|----------|----------------|
| 300201 | RD-TJ01 | 2 | 6.3 | 130 | 300 | 3800123136139 |
| 300207 | RD-TJ01 | 2 | 6.3 | 130 | 300 | 3800123136504 |
| 300202 | RD-TJ02 | 2 | 11.2 | 125 | 390 | 3800123136146 |
| 300209 | RD-TJ06 | 2 | 12.6 | 85 | 380 | 38001231363968 |
| 300205 | RD-TJ04 | 3 | 18.1 | 138 | 420 | 3800123136245 |
| 300204 | RD-TJ03 | 3 | 34 | 120 | 495 | 3800123136153 |
| 300208 | RD-TJ05 | 3 | 29 | 135 | 500 | 38001231363845 |

FARM JACK RD-FJ01

• [BG] Крик високоповдигащ • [RO] Cric H-Lift • [SR] Dizalica velika stora • [MK] Дигалка H-Lift • [RU] Домкрат реечный автомобильный • [SL] Dvigalo Ročno • [EL] Γρύλος αυτοκινήτου • [HR] Hi-lift dizalica • [FR] La prise est rack voiture • [IT] Il jack è rack automobilistico • [ES] La kato estas rako aũto • [PT] O jack é rack de automóvel

MAX. HEIGHT 48" / 120 cm



| Art.No | gross weight | in cartoon | barcode |
|--------|--------------|------------|---------------|
| 309904 | 12.650 kg | | 3800123173776 |

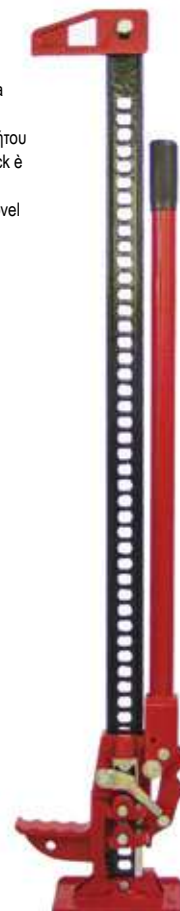

SCISSOR JACK

• [BG] Крик винтов тип "жаба" • [RO] Cric foarfeca • [SR] Dizalica sa navojem • [MK] Рачна Дигалка • [RU] Ножничный подъемник • [SL] škarjasto Dvigalo • [EL] Γρύλος Μηχανικός • [HR] Trapez dizalica • [FR] La prise est rack voiture • [IT] Il jack è rack automobilistico • [ES] La kato estas rako auto • [PT] O jack é rack de automóvel



| Art.No | gross weight | in cartoon | barcode |
|--------|--------------|------------|---------------|
| 309903 | 2.080 kg | 10 pcs | 3800123154942 |

AXLE STANDS PAIR 2 PCS SET

• [BG] Стойки за автомобил с гребен • [RO] Set 2 buc. cric hidraulic • [SR] Držač par • [MK] Држач • [RU] Стенды за автомобиль с гребнем • [SL] Stojalo za avto par • [EL] Βάσεις αυτοκινήτο • [HR] Podupirači • [FR] La prise est rack voiture • [IT] Il jack è rack automobilistico • [ES] La kato estas rako auto • [PT] O jack é rack de automóvel



| Art.No | gross weight | in cartoon | barcode |
|--------|--------------|------------|---------------|
| 300702 | 5.330 kg | 6 pcs | 3800123136214 |

HYDRAULIC BODY REPAIR KIT RD-PHE03

• [BG] Разпъвачка хидравлична за автомобили • [RO] Echipament hidraulic • [SR] Autolimarska oprema za razvlačenje • [MK] Хидраулични комплет за исправанье • [RU] Комплект гидравлический для рихтовки кузова • [SL] Komplet za popravilo udrtinna osnovi hidravlike • [EL] Σετ επισκευων υδραυλικων υστισκευων • [HR] Autolimarska oprema za razvlačenje • [FR] Kit hydraulique pour le soutien du corps • [IT] Kit idraulico per la pastura del corpo • [ES] Hidraulica kit por korpoj • [PT] Kit esticador hidraulico

| CAPACITY (TON) | STROKE (mm) | MIN. HEIGHT (mm) | MAX. HEIGHT (mm) |
|----------------|-------------|------------------|------------------|
| 4 | 18 | 42 | 58 |
| 10 | 57 | 132 | 189 |
| 2 | 70 | 139 | 240 |
| 4 | 125 | 275 | 405 |
| 10 | 150 | 350 | 500 |
| 5 | 130 | 520 | 650 |



METAL CASE

| Art.No | gross weight | barcode |
|--------|--------------|---------------|
| 300612 | 23.600 kg | 3800123173783 |

HYDRAULIC BODY REPAIR KIT

• [BG] Разпъвачка хидравлична за автомобили • [RO] Echipament hidraulic • [SR] Autolimarska oprema za razvlačenje • [MK] Хидраулични комплет за исправанье • [RU] Комплект гидравлический для рихтовки кузова • [SL] Komplet za popravilo udrtinna osnovi hidravlike • [EL] Σετ επισκευων υδραυλικων υστισκευων • [HR] Autolimarska oprema za razvlačenje • [FR] Kit hydraulique pour le soutien du corps • [IT] Kit idraulico per la pastura del corpo • [ES] Hidraulica kit por korpoj • [PT] Kit esticador hidraulico

RD-PHE04



| CAPACITY (TON) | STROKE (mm) | MIN. HEIGHT (mm) | MAX. HEIGHT (mm) |
|----------------|-------------|------------------|------------------|
| 4 | 18 | 42 | 58 |
| 10 | 57 | 132 | 189 |
| 2 | 70 | 139 | 240 |
| 4 | 120 | 275 | 395 |
| 10 | 135 | 325 | 460 |
| 5 | 155 | 345 | 500 |
| 20 | 145 | 325 | 470 |
| 15 | | 250 | 420 |



| Art.No | gross weight | barcode |
|--------|--------------|---------------|
| 300613 | 39.000 kg | 3800972005679 |

RD-PHE05
4T
17 kg

| CAPACITY (TON) | STROKE (mm) | MIN. HEIGHT (mm) | MAX. HEIGHT (mm) |
|----------------|-------------|------------------|------------------|
| 4 | 18 | 42 | 58 |
| 10 | 57 | 132 | 189 |
| 2 | 70 | 139 | 240 |
| 4 | 120 | 275 | 395 |
| 10 | 135 | 325 | 460 |
| 5 | 155 | 345 | 500 |
| 20 | 145 | 325 | 470 |
| 15 | | 250 | 420 |

| Art.No | gross weight | in cartoon | barcode |
|--------|--------------|------------|---------------|
| 300614 | 18.000 kg | 1 | 3800972005686 |

RD-PHE06
15T
43 kg

| CAPACITY (TON) | STROKE (mm) | MIN. HEIGHT (mm) | MAX. HEIGHT (mm) |
|----------------|-------------|------------------|------------------|
| 4 | 18 | 42 | 58 |
| 10 | 57 | 132 | 189 |
| 2 | 70 | 139 | 240 |
| 4 | 120 | 275 | 395 |
| 10 | 135 | 325 | 460 |
| 5 | 155 | 345 | 500 |
| 20 | 145 | 325 | 470 |
| 15 | | 250 | 420 |

| Art.No | gross weight | in cartoon | barcode |
|--------|--------------|------------|---------------|
| 300615 | 33.000 kg | 1 | 3800972005693 |

RD-PHE07
20T
57 kg

| CAPACITY (TON) | STROKE (mm) | MIN. HEIGHT (mm) | MAX. HEIGHT (mm) |
|----------------|-------------|------------------|------------------|
| 4 | 18 | 42 | 58 |
| 10 | 57 | 132 | 189 |
| 2 | 70 | 139 | 240 |
| 4 | 120 | 275 | 395 |
| 10 | 135 | 325 | 460 |
| 5 | 155 | 345 | 500 |
| 20 | 145 | 325 | 470 |
| 15 | | 250 | 420 |

| Art.No | gross weight | in cartoon | barcode |
|--------|--------------|------------|---------------|
| 300616 | 58.000 kg | 1 | 3800972005709 |

2 METAL CASES
HYDRAULIC BENCH PRESS WITH PRESSURE GAUGE

• [BG] Преса хидравлична настолна с манометър • [RO] Presa hidraulica • [SR] Hidraulična presa • [MK] Хидраулична преса • [RU] Пресс гидравлический настольный • [SL] Hidravlične stiskalnice • [EL] υδραυλική πρέσα • [HR] Ručna hidraulična preša • [FR] Presse de banc hydraulique avec manomètre • [IT] Banco da banco idraulico con manometro • [ES] Hidraúlika benka gazetaró kun premómetro • [PT] Prensa hidráulica

RD-HP02
10T
50 kg

| Art.No | gross weight | in cartoon | barcode |
|--------|--------------|------------|---------------|
| 300604 | 50.700 kg | 1 | 3800123173691 |



HYDRAULIC FLOOR PRESS RD-HP1

[BG] Преса хидравлична настолна • [RO] Presa hidraulica • [SR] Hidraulična presa • [MK] Хидраулична преса • [RU] Пресс гидравлический настольный • [SL] Hidravlične stiskalnice • [EL] Υδραυλική πρέσα • [HR] Ručna hidraulična preša • [FR] Presse de banc hydraulique [IT] Banco da banco idraulico • [ES] Hidráulica benka • [PT] Prensa hidráulica

12T
42 kg



| Art.No | gross weight | barcode |
|--------|--------------|---------------|
| 300603 | 42.500 kg | 3800123128417 |

RD-HP03

12T
66 kg



| Art.No | gross weight | barcode |
|--------|--------------|---------------|
| 300605 | 66.800 kg | 3800123173707 |

RD-HP04

20T
86 kg



| Art.No | gross weight | barcode |
|--------|--------------|---------------|
| 300606 | 86.800 kg | 3800123173714 |

PNEUMATIC PRESS WITH PRESSURE GAUGE RD-HP05

[BG] Преса хидравлична с манометър и пневматично управление • [RO] Presa pneumatica cu manometru • [SR] Pnevmatiska presa • [MK] Пневматски преса • [RU] Пресс пневматический настольный [SL] Pnevmatiska stiskalnice • [EL] Πνευματικός πρέσα • [HR] Ručna pneumatska preša • [FR] Presse pneumatique de table • [IT] Pressa pneumatica da tavolo • [ES] Tabla pneumática gazetario • [PT] Prensa hidráulica

20T
86.5 kg



| Art.No | gross weight | barcode |
|--------|--------------|---------------|
| 300607 | 88.000 kg | 3800123173721 |

SINGLE CYLINDER TRANSMISSION JACK RD-TRJ01

[BG] Крик за скоростни кутии • [RO] Cric hidraulic pentru cutii de viteze • [SR] Dizalica za menjač • [MK] Дигалка за менџач • [RU] Домкрат трансмиссионные • [SL] Dvigalka za menjalnik • [EL] Γρούλος κιβώτιο ταχυτήτων • [HR] Dizalica za mjenjač • [FR] Cric de transmission monocylindre • [IT] Jack di trasmissione a singolo cilindro • [ES] Transdono jack • [PT] Jack de transmissão

min H 1000 mm
max H 1900 mm
0.5T
29.00 kg



| Art.No | gross weight | barcode |
|--------|--------------|---------------|
| 300608 | 29.000 kg | 3800123173738 |

ENGINE STAND RD-ESTO1

[BG] Стойка за двигатели • [RO] Suport pentru motor • [SR] Nosač motora • [MK] Држач за мотор • [RU] Стенд для двигателя • [SL] Stojalo za motor • [EL] Σταντ Κινητήρα • [HR] Nosac motora • [FR] Stand pour les moteurs • [IT] Supporto per motori • [ES] Stari por motoroj • [PT] Suporte para motores

567kg max LOAD
27.00 kg



| Art.No | gross weight | barcode |
|--------|--------------|---------------|
| 300609 | 27.000 kg | 3800123173745 |

HYDRAULIC PIPE BLENDER RD-HPB01

[BG] Тръбогиб хидравличен • [RO] Dispozitiv hidraulic pentru indoiti tevi • [SR] Savijač cevi hidraulični • [MK] Хидраулични Цевки Бендер • [RU] Трубогиб гидравлический • [SL] Navpični hidravlični stroj za krivljenje cevi • [EL] Υδραυλικός Κουρμπάδορος Σωλήνων • [HR] Savijač cijevi hidraulički • [FR] Cintreuse hydraulique • [IT] Curvatubi idraulico • [ES] Hidráulica tubaro • [PT] Dobrador de tubo hidraulico

1/2" + 3/4" + 1" + 1 1/4" + 1 1/2" + 2"

12T
min H 320 mm
max H 570 mm
1/2"-2"
31.200 kg



| Art.No | gross weight | barcode |
|--------|--------------|---------------|
| 300610 | 31.700 kg | 3800123173752 |



HYDRAULIC GEAR PULLER 3 JAW RD-HGPO1

• [BG] Скоба за лагери трираменна хидравлична • [RO] Extractor hidraulic cutie de viteze • [SR] Hidraulični radapciger • [MK] Хидраулични извлекувач со 3 рамена • [RU] Гидравлические съёмник подшипников • [SL] Hidravlični snemalec 3 kos • [EL] Υδραυλικό σет Εξολκέας • [HR] Hidraulični radapciger • [FR] Presse pneumatique de table • [IT] Pressa pneumatica da tavolo • [ES] Tabla pneumática gazetaro • [PT] Saca-rolamentos hidraulico

5T

max H
200
mm



max LOAD
5000 kg

| Art.No | gross weight | in cartoon | barcode |
|--------|--------------|------------|---------------|
| 300611 | 5.880 kg | 2 pcs | 3800123173769 |

HYDRAULIC ENGINE HOIST RD-HEHO1

• [BG] Кран за повдигане на двигатели • [RO] Macara Hidraulica tip "Girafa" • [SR] Dizalica za podizanje motora • [MK] Кран за диғање на мотори • [RU] Кран гидравлический • [SL] Dvigalo motorjev • [EL] Υδραυλικός γερανός κινητήρων • [HR] Radionički Kran • [FR] Palan à moteur hydraulique • [IT] Paranco motore idraulico • [ES] Levilo de hidráulica motoro • [PT] Talha hidráulica do motor

1T

**67
kg**

COLOR BOX



max LOAD
1000 kg

| Art.No | gross weight | barcode |
|--------|--------------|---------------|
| 309901 | 66.800 kg | 3800123136221 |

HYDRAULIC CYLINDER FOR HYDRAULIC ENGINE HOIST

• [BG] Силво цилиндър за кран за повдигане на двигатели • [RO] Cilindu hidraulic pentru ridicarea motorului • [SR] Hidraulični cilindar za podizanje hidrauličnih motora • [MK] Хидрауличен цилиндер за дигалка на хидрауличен мотор • [RU] Гидравлический цилиндр для подъема двигателя • [SL] Hidravlični cilindar za dvigalo hidravličnega motorja • [EL] Υδραυλικός κύλινδρος για υδραυλικό ανυψωτικό κινητήρα • [HR] Hidraulični cilindar za dizalicu motora • [FR] Vérin hydraulique pour palan moteur • [IT] Cilindro idraulico per paranco motore • [ES] Hidráulica cilindro por levado de motoro • [PT] Cilindro hidráulico para talha do motor

**NEW
PRODUCT**



max LOAD
1000 kg - Art. No. 309905
2000 kg - Art. No. 309906

| Art.No | Capacity | gross weight | barcode |
|--------|----------|--------------|---------------|
| 309905 | 1T | 14.000 kg | 3800972003071 |
| 309906 | 2T | 10.000 kg | 3800972003088 |



ELECTRIC CHAIN SAW

• [BG] Ръзачка електрическа • [RO] Fierastrau electric cu lant • [SR] Električna motorna testera • [MK] Електрична пила • [RU] Электрические цепные пилы • [SL] Električna žaga • [EL] Ηλεκτρικό αλυσοπρίονο
 • [HR] Električna lančana pila • [FR] Scie à chaîne électrique • [IT] Sega a catena elettrica • [ES] Elektra segilo • [PT] Moto-serra elétrica

RD-ECS21

**NEW
PRODUCT**

230V~
50Hz

1800
W

12.5 m/s

14"
355mm

AUTO

0.12
sec

0,05"(1,3mm)

3/8"

X 52

4.7
kg

COLOR BOX



ERGONOMIC
HANDLE

| Art.No | gross weight | in cartoon | barcode |
|--------|--------------|------------|---------------|
| 075115 | 5.480 kg | 2 pcs | 3800972015418 |

RD-ECS22

**NEW
PRODUCT**

230V~
50Hz

2000
W

12.5 m/s

16"
400mm

AUTO

0.12
sec

0,05"(1,3mm)

3/8"

X 57

4.900
kg

COLOR BOX



ERGONOMIC
HANDLE

| Art.No | gross weight | in cartoon | barcode |
|--------|--------------|------------|---------------|
| 075116 | 5.600 kg | 2 pcs | 3800972015425 |

RD-ECS16X

NEW PRODUCT

| | | |
|---------------|-------------|-----------|
| 230V~ 50Hz | 2000 W | 12.5 m/s |
| 14" 355mm | AUTO | 0.12 sec |
| 0,05"(1,3mm) | 3/8" | X 52 |
| | 4.540 kg | COLOR BOX |



| Art.No | gross weight | in cartoon | barcode |
|--------|--------------|------------|---------------|
| 075110 | 4.990 kg | 2 pcs | 3800972002272 |

RD-ECS23

NEW PRODUCT

| | | |
|---------------|-------------|-----------|
| 230V~ 50Hz | 2000 W | 12.5 m/s |
| 16" 400mm | AUTO | 0.12 sec |
| 0,05"(1,3mm) | 3/8" | X 57 |
| | 4.800 kg | COLOR BOX |



| Art.No | gross weight | in cartoon | barcode |
|--------|--------------|------------|---------------|
| 075117 | 5.270 kg | 2 pcs | 3800972015432 |

RD-ECS17X

NEW PRODUCT

| | | |
|---------------|-------------|-----------|
| 230V~ 50Hz | 2000 W | 12.5 m/s |
| 16" 400mm | AUTO | 0.12 sec |
| 0,05"(1,3mm) | 3/8" | X 57 |
| | 4.920 kg | COLOR BOX |



OREGON

| Art.No | gross weight | in cartoon | barcode |
|--------|--------------|------------|---------------|
| 075111 | 5.270 kg | 2 pcs | 3800972002289 |

RD-ECS18X

NEW PRODUCT

| | | |
|---------------|-------------|-----------|
| 230V~ 50Hz | 2200 W | 12.5 m/s |
| 16" 400mm | AUTO | 0.12 sec |
| 0,05"(1,3mm) | 3/8" | X 57 |
| | 5.420 kg | COLOR BOX |



OREGON

| Art.No | gross weight | in cartoon | barcode |
|--------|--------------|------------|---------------|
| 075112 | 5.750 kg | 2 pcs | 3800972002296 |

RD-ECS24

**NEW
PRODUCT**

| | | |
|---------------|-------------|-------------|
| 230V~ 50Hz | 2400 W | 12.5 m/s |
| 16" 400mm | AUTO | 0.12 sec |
| 0,05"(1,3mm) | 3/8" | X 57 |
| | 4.730 kg | COLOR BOX |



OREGON

| Art.No | gross weight | in cartoon | barcode |
|--------|--------------|------------|---------------|
| 075118 | 6.250 kg | 2 pcs | 3800972015449 |

RD-ECS20X

| | | |
|---------------|-------------|-------------|
| 230V~ 50Hz | 2400 W | 12.5 m/s |
| 16" 400mm | AUTO | 0.12 sec |
| 0,05"(1,3mm) | 3/8" | X 57 |
| | 4.800 kg | COLOR BOX |



OREGON

| Art.No | gross weight | in cartoon | barcode |
|--------|--------------|------------|----------------|
| 075114 | 5.750 kg | 2 pcs | 38009720142999 |

RD-ECS19

| | | |
|---------------|-------------|-------------|
| 230V~ 50Hz | 2400 W | 12.5 m/s |
| 16" 400mm | AUTO | 0.12 sec |
| 0,05"(1,3mm) | 3/8" | X 57 |
| | 4.920 kg | COLOR BOX |



OREGON

| Art.No | gross weight | in cartoon | barcode |
|--------|--------------|------------|---------------|
| 075113 | 6.080 kg | 2 pcs | 3800972003545 |

RD-ECS25

**NEW
PRODUCT**

| | | |
|---------------|-------------|-------------|
| 230V~ 50Hz | 2400 W | 12.5 m/s |
| 18" 450mm | AUTO | 0.12 sec |
| 0,05"(1,3mm) | 3/8" | X 62 |
| | 5.550 kg | COLOR BOX |



| Art.No | gross weight | in cartoon | barcode |
|--------|--------------|------------|---------------|
| 075119 | 6.300 kg | 2 pcs | 3800972015456 |

GASOLINE CHAIN SAW

• [BG] Ресачка бензинова • [RO] Motofierastrau benzina cu lant • [SR] Benzinska lancana testera • [MK] Моторна пила • [RU] Цепная пила газоліна • [SL] Motornih žag • [EL] Βενζινοκίνητο Αλυσοπίριον
 • [HR] Motorna pila • [FR] Scie à chaîne essence • [IT] Motosega a benzina • [ES] Gasoline čeno vidis • [PT] Moto-serra a gasolin

RD-GCS24

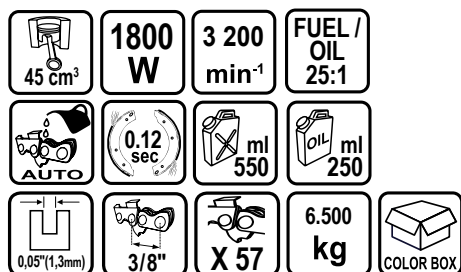

**NEW
PRODUCT**

RAIDER **4** ANTI-VIBRATION POINT SYSTEM

| art. № | guide bar length /mm/ | teeth | gross weight | in cartoon | BARCODE |
|-----------------|-----------------------|-------|--------------|------------|---------------|
| 076706 RD-GCS24 | 400 | 57 | 7.040 kg | 2 pcs | 3800972019423 |



RAIDER **4** ANTI-VIBRATION POINT SYSTEM

| art. № | guide bar length /mm/ | teeth | gross weight | in cartoon | BARCODE |
|-----------------|-----------------------|-------|--------------|------------|---------------|
| 076704 RD-GCS22 | 350 | 60 | 7.040 kg | 2 pcs | 3800972014336 |
| 075104 RD-GCS13 | 400 | 64 | 7.040 kg | 2 pcs | 3800123169847 |



**ERGONOMIC
HANDLE**

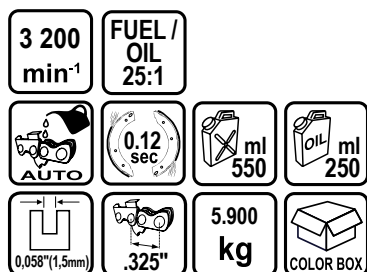

RAIDER **4** ANTI-VIBRATION POINT SYSTEM

| art. № | W | displacement | guide bar length /mm/ | teeth | gross weight | in cartoon | BARCODE |
|-----------------|------|--------------|-----------------------|-------|--------------|------------|---------------|
| 075105 RD-GCS14 | 2000 | 52 cm³ | 400 | 64 | 6.500 kg | 2 pcs | 3800123169885 |
| 075106 RD-GCS15 | 2200 | 58 cm³ | 450 | 72 | 6.500 kg | 2 pcs | 3800123169892 |



**ERGONOMIC
HANDLE**

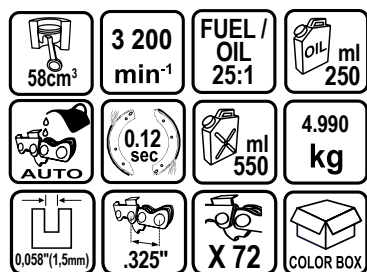

**NEW
PRODUCT**

RAIDER **4** ANTI-VIBRATION POINT SYSTEM

| art. № | W | guide bar length /mm/ | teeth | gross weight | in cartoon | BARCODE |
|-----------------|------|-----------------------|-------|--------------|------------|---------------|
| 076701 RD-GCS19 | 2200 | 450 | 72 | 6.500 kg | 2 pcs | 3800972004177 |
| 076702 RD-GCS20 | 2200 | 450 | 72 | 6.500 kg | 2 pcs | 3800972004184 |



**ERGONOMIC
HANDLE**

RDP-GCS07

| | | | |
|--|-----------------|-------------------------------|-----------------|
| | 1800 W | 3 200 min⁻¹ | |
| | 0.12 sec | | |
| | | | 7.700 kg |
| | | | |



RAIDER Pro

EasyOn



| Art.No | gross weight | in carton | barcode |
|--------|--------------|-----------|---------------|
| 129993 | 8.500 kg | 2 pcs | 3800123133435 |

RDP-GCS08

| | | | |
|--|-----------------|-------------------------------|-----------------|
| | 2200 W | 3 200 min⁻¹ | |
| | 0.12 sec | | |
| | | | 7.200 kg |
| | | | |



RAIDER Pro

EasyOn



| Art.No | gross weight | in carton | barcode |
|--------|--------------|-----------|---------------|
| 129994 | 8.000 kg | 2 pcs | 3800123133442 |

RDP-GCS21

| | | | | |
|--|---------------|-------------------------------|------------------------|--|
| | 2200 W | 3 200 min⁻¹ | | |
| | | | FUEL / OIL 25:1 | |
| | | | 7.2 kg | |



RAIDER Pro

NEW PRODUCT



| Art.No | gross weight | in carton | barcode |
|--------|--------------|-----------|---------------|
| 076703 | 7.750 kg | 2 pcs | 3800972004191 |

RDP-GCS25

| | | | | |
|--|---------------|--|------------------------------------|--|
| | 2400 W | idle speed 3 200 min⁻¹ | max 10 500 min⁻¹ | |
| | | | FUEL / OIL 25:1 | |
| | | | 6.9 kg | |



NEW PRODUCT

RAIDER Pro

EasyOn

SOFT TOUCH HANDLE

ALUMINIUM STARTER BODY



AIR FILTER

| Art.No | barcode |
|--------|---------------|
| 140125 | 3800972019706 |

| Art.No | gross weight | in carton | barcode |
|--------|--------------|-----------|---------------|
| 076707 | 7.350 kg | 2 pcs | 3800972019218 |

RDP-GCS23

| | | | | |
|--|---------------|-------------------------------|------------------------|--|
| | 2800 W | 3 200 min⁻¹ | | |
| | | | FUEL / OIL 25:1 | |
| | | | 7.5 kg | |



NEW PRODUCT

RAIDER Pro

EasyOn



| Art.No | gross weight | in carton | barcode |
|--------|--------------|-----------|---------------|
| 076705 | 8.000 kg | 2 pcs | 3800972015487 |

RDP-GCS18

| Art.No | gross weight | in cartoon | barcode |
|--------|--------------|------------|---------------|
| 075109 | 4.980 kg | 2 pcs | 3800123174087 |

ELECTRIC CHAIN SAW SHARPENER RD-CSS01

• [BG] Машина за точене на вериги • [RO] Aparat de ascutire lant drijba • [SR] Mašina za oštrenje lanca motorke • [MK] Машина за оштрење за ланец • [RU] Станки для заточки цепей • [SL] Brusilni stroj za brušenje verig • [EL] Τροχιστής αλυσίδας αλυσσπριου • [HR] Stroj za oštrenje lanaca • [FR] Aiguiseur de tronçonneuse électrique • [IT] Affilcoltelli elettrico • [ES] Elektra mastruma motilo • [PT] Apontador de motosserra elétrica

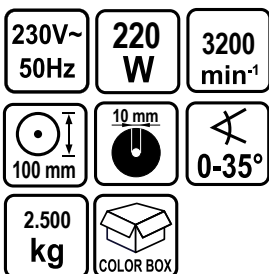

Ø 100 mm

| Art.No | gross weight | in cartoon | barcode |
|--------|--------------|------------|---------------|
| 140108 | 2.620 kg | 4 pcs | 3800123163210 |

LOG SPLITTER RD-LGS01T

• [BG] Машина за цепене на дърва • [RO] Dispozitiv pentru despicat busteni • [SR] Сераџ за дрва • [MK] Цепач на дрва • [RU] Машина для колки дров • [SL] Sepilec drv • [EL] Τεμαχιστής Ξύλων (Τριφασικός) • [HR] Stroj za cijepanje дрва • [FR] Machine à couper le bois • [IT] Trinciatrice del legno • [ES] Tajrado de ligno • [PT] Rachador de lenha

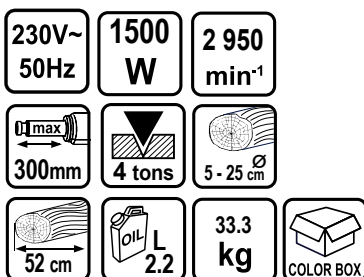

Ø 50 - 250 mm



520 mm

| Art.No | gross weight | in cartoon | barcode |
|--------|--------------|------------|---------------|
| 129939 | 37.000 kg | 1 | 3800123123009 |

ELECTRIC BLOWER AND SHREDDER

• [BG] Листосъбирач • [RO] Sufianta / aspirator • [SR] Usisač lišća • [MK] Всмуквач за листа • [RU] Пылесос для листьев • [SL] Sesalnik za listje • [EL] Μηχανής αναρρόφησης φύλλων • [HR] Električni Usisavač / Puhalo Lišća • [FR] Aspirateur à feuilles • [IT] Aspirapolvere a foglia • [ES] Folia polvosucilo • [PT] Soprador/aspirador eléctrico

RD-EBV03

STRAP

VARIABLE SPEED

BAG CAPACITY 30 L

| Art.No | gross weight | in cartoon | barcode |
|--------|--------------|------------|---------------|
| 075522 | 3.800 kg | | 3800972002074 |

RD-EBV04

| | |
|--------------------------|-------------------------------------|
| 230V~ 50Hz | 3000 W |
| SPEED 270 km/h | 9000- 15000 min ⁻¹ |
| 13.2 m ³ /min | LEAVES BAG 35 L |
| 4.3 kg | COLOR BOX |



VARIABLE SPEED



BAG CAPACITY
35 L

| Art.No | gross weight | in carton | barcode |
|--------|--------------|-----------|---------------|
| 075529 | 5.300 kg | 4 pcs | 3800972002050 |

GASOLINE BLOWER AND VACUUM RD-GBV05

• [BG] Листосъбирач бензинов • [RO] Sufianta / aspirator pentru benzina • [SR] Usisač lišća benzina • [MK] Вомукувач за лисја бензина • [RU] Бензин пылесос для листьев • [SL] Sesalnik za listje
• [EL] Μηχανής αναρρόφησης φύλλων • [HR] Električni Usisavač / Puhalo Lišća • [FR] Aspirateur à essence • [IT] Aspirapolvere a benzina • [ES] Gasolina blavilo malplena • [PT] Soprador a gasolina

| | |
|-----------------------|---------------------------|
| 750 W | 6500 min ⁻¹ |
| SPEED 130m/s | 13.2 m ³ /min |
| FUEL / OIL 25:1 | ml 650 |
| LEAVES BAG 30 L | 4.700 kg |
| | COLOR BOX |



13.2 m³/min



BAG CAPACITY
30 L

| Art.No | gross weight | barcode |
|--------|--------------|---------------|
| 077401 | 5.200 kg | 3800972003712 |

GASOLINE BACKPACK BLOWER RD-GBV06

• [BG] Моторна метла • [RO] Aspirator/sufianta pe benzina • [SR] benzinski ranac puhač • [MK] Метла за лисја бензина • [RU] Бензин пылесос для метены • [SL] Sesalnik za listje
• [EL] Μηχανής αναρρόφησης φύλλων • [HR] Električni Usisavač / Puhalo Lišća • [FR] Aspirateur à essence • [IT] Aspirapolvere a benzina • [ES] Gasolina blavilo malplena • [PT] Soprador a gasolina

*Двигател: Едноцилиндров, бензинов,
двухтактен с въздушно охлаждане*

| | | |
|-----------------------|---------------------------|------------------------|
| 1250 W | 7000 min ⁻¹ | NEW PRODUCT |
| SPEED 252m/s | ml 1200 | |
| FUEL / OIL 25:1 | 8.300 kg | COLOR BOX |







| Art.No | gross weight | barcode |
|--------|--------------|---------------|
| 077402 | 9.500 kg | 3800972015630 |

ELECTRIC TILLER

• [BG] Мотофреза електрическа • [RO] Electrocultor • [SR] Baštenska freza • [MK] Електричен култиватор • [RU] Электрических румпель • [SL] Električni prekopalnik • [EL] Φρεζα Ηλεκτρική
• [HR] Električna koračica • [FR] Motoculteur électrique • [IT] Timone elettrico • [ES] Elektra cultivadora • [PT] Cultivadora

RD-ET01J

| | |
|---|---|
| 230V~ 50Hz | 750 W |
| 400 min ⁻¹ |  300mm |
|  200mm |  Ø220mm |
| 7.100 kg |  COLOR BOX |







Ø 220 mm



TILLER WIDTH
300 mm

| Art.No | gross weight | in cartoon | barcode |
|--------|--------------|------------|---------------|
| 095101 | 8.700 kg | 1 pcs | 3800123163340 |

RD-ET03

| | |
|--|---|
| 230V~ 50Hz | 1000 W |
| 430 min ⁻¹ |  365mm |
|  180mm |  Ø220mm |
| 10.800 kg |  COLOR BOX |







Ø 220 mm



TILLER WIDTH
365 mm

| Art.No | gross weight | in cartoon | barcode |
|--------|--------------|------------|---------------|
| 095113 | 15.540 kg | 2 pcs | 3800972003552 |

RD-ET02

| | |
|---|---|
| 230V~ 50Hz | 1500 W |
| 200 min ⁻¹ |  450mm |
|  180mm |  Ø220mm |
| 10.00 kg |  COLOR BOX |



Ø 220 mm



TILLER WIDTH
450 mm

| Art.No | gross weight | in cartoon | barcode |
|--------|--------------|------------|---------------|
| 095108 | 13.500 kg | 2 pcs | 3800123174681 |

GASOLINE TILLER

• [BG] Мотофреза бензинова • [RO] Motocultor • [SR] Baštenska freza • [MK] Бензинов култиватор
• [RU] Культиватор бензиновый • [SL] Bencin prekopalnik • [EL] Βενζίνη ηλεκτρική • [HR] Benzinska vrt freza •
[FR] Motoculteur essence • [IT] Motozappa benzina • [ES] Benzina cultivador • [PT] Motocultivador

RD-T09

| | | | |
|---|---|--|------------------------|
|  16l cm ³ | 3.0 kW | 3600 min ⁻¹ | NEW PRODUCT |
|  600mm |  150-260mm |  Ø270mm | |
|  1200 ml |  400 ml |  | 31 kg |
|  COLOR BOX | | | |







Ø 270 mm



TILLER WIDTH
600 mm

| Art.No | gross weight | in cartoon | barcode |
|--------|--------------|------------|---------------|
| 076904 | 36.000 kg | 1 pcs | 3800972015562 |

RD-T08

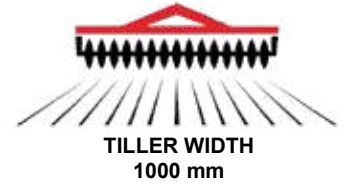
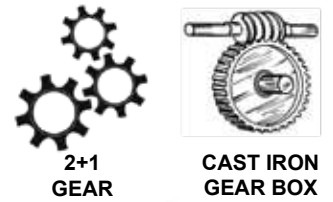
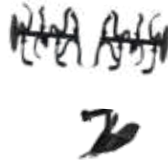

| | | |
|--|---|--|
|  208cm ³ | 5.2 kW | 2500 min⁻¹ |
|  1000mm |  150-350mm |  2+1 GEAR |
|  3600 ml |  600 ml |  86 kg |

 COLOR BOX



| Art.No | gross weight | barcode |
|--------|--------------|---------------|
| 076903 | 93.400 kg | 3800972015203 |

RD-T11





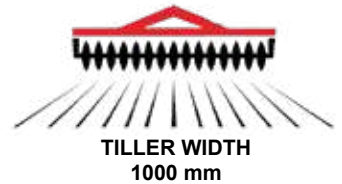
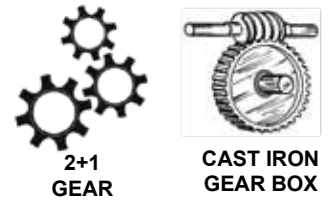

| | | |
|--|--|--|
|  208cm ³ | 5.2 kW | 2500 min⁻¹ |
|  1000mm |  150-350mm |  2+1 GEAR |
|  3600 ml |  600 ml |  87.00 kg |

 COLOR BOX



| Art.No | gross weight | barcode |
|--------|--------------|---------------|
| 076908 | 99.500 kg | 3800972018037 |

RD-T03

| | | |
|--|---|--|
|  208cm ³ | 5.2 kW | 2500 min⁻¹ |
|  1000mm |  150-350mm |  2+1 GEAR |
|  3600 ml |  600 ml |  102 kg |

 COLOR BOX

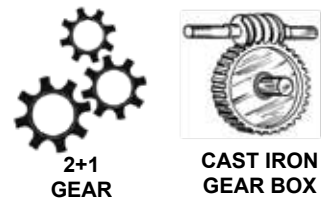

| Art.No | gross weight | barcode |
|--------|--------------|---------------|
| 095102 | 107.000 kg | 3800123170867 |

RD-T07

| | | |
|--|---|--|
|  208cm ³ | 5.2 kW | 2500 min⁻¹ |
|  1000mm |  100-350mm |  2+1 GEAR |
|  3600 ml |  600 ml |  97 kg |

 COLOR BOX

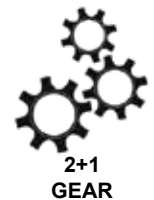

| Art.No | gross weight | barcode |
|--------|--------------|---------------|
| 095112 | 107.800 kg | 3800972001404 |

BELT DRIVEN ROTARY DISC MOWER FOR TILLERS

• [BG] Прикачна роторна дискова косачка за мотофреза • [RO] Accesoriu motocultor cu functie de motocosoitoare • [SR] Diskna kosilica na rotoru za glodalicu • [MK] Косилка за дискови на роторот за прицврстување за машина за мелење • [RU] Навесная дисковая косилка для фрезерного станка • [SL] Pritrdilna rotorska diskovna kosilnica za rezkalni stroj • [EL] Κοσσιδόρος δίσκου ρότορα συναρμολόγητος για φρεζόρισμα • [HR] Diskna kosilica na rotoru za glodalicu • [FR] Accessoire tondeuse à disque à rotor pour fraiseuse • [IT] Falciatrice a dischi rotore di attacco per fresatrice • [ES] Aldona rotor-disko-faligilo por muelilo • [PT] Cortador de disco de rotor de acessórios para fresadora

**NEW
PRODUCT**



| Art.No | gross weight | barcode |
|--------|--------------|---------------|
| 110292 | 32.500 kg | 3800972015975 |



CONNECTOR FOR BELT DRIVEN ROTARY DISC MOWER



| Art.No | gross weight | barcode |
|--------|--------------|---------------|
| 110293 | 4.500 kg | 3800972016309 |

GASOLINE TILLER

• [BG] Мотофреза бензинова • [RO] Cultivator benzină • [SR] Baštenska freza • [MK] Бензинов култиватор • [RU] Культиватор бензиновый • [SL] Bencin prekopalnik • [EL] Βενζίνη ηλεκτρική • [HR] Benzinska vrt freza • [FR] Motoculteur essence • [IT] Motozappa benzina • [ES] Benzina cultivador • [PT] Motocultivador

RD-T06

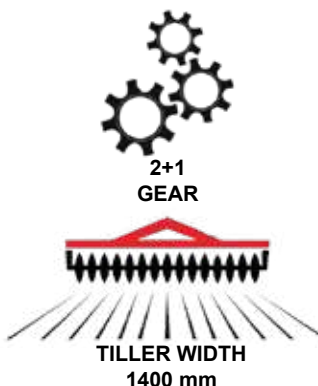

| Art.No | gross weight | barcode |
|--------|--------------|---------------|
| 095111 | 131.600 kg | 3800972000834 |

RD-T10

**NEW
PRODUCT**

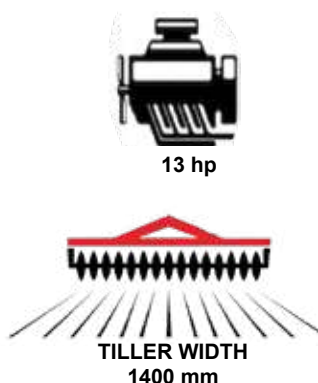

| Art.No | gross weight | barcode |
|--------|--------------|---------------|
| 076905 | 123 kg | 3800972015579 |

TRAILER FOR POWER TILLER RD-T03

• [BG] Ремарке за мотофреза бензинова RD-T03 • [RO] Remorcă • [SR] Prikolica • [MK] Приколка • [RU] Прицеп для мотоблока • [SL] Prikolica • [EL] Τρέιλερ • [HR] Prikolica • [FR] Remorque de remorque de fraissage d'essence • [IT] Rimorchio del rimorchio di macinazione della benzina • [ES] Antaúfilmo de benzina muelejo • [PT] Reboque para trituração a gasolina

**NEW
PRODUCT**

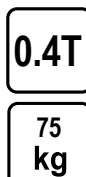

Dimensions: 2650 x 850 x 850 mm

- Loading area: 1m²
- High pass
- Ground clearance: 200 mm

| Art.No | barcode |
|--------|---------------|
| 076907 | 3800123174544 |

EARTH AUGER

• [BG] Моторен свредел • [RO] Motoburghiu • [SR] Motorna bušilica zemlje • [MK] Моторна дупчалка • [RU] Сверло земли газolina • [SL] Vrtalnik za zemljo • [EL] Τριβέλα - Γεωτρύπανο Βενζίνης
 • [HR] Motorna bušilica za zemlju • [FR] Perceuse à essence • [IT] Trapano a benzina • [ES] Benzina grundo • [PT] Abre-buracos

**NEW
PRODUCT**



| Art.No | gross weight | in cartoon | barcode |
|--|--------------|------------|---------------|
| 095109 RD-EA01 | 9.880 kg | | 3800123174858 |
| 095114 RD-EA02 with drill bit 200x820mm | 13.730 kg | | 3800972017269 |

DRILL FOR EARTH AUGER

• [BG] Свредло за моторен свредел • [RO] Burghiu de pamant • [SR] Burgije za bušač • [MK] Бургија за моторна дупчалка • [RU] Сверло земли • [SL] Sveder za zemljo • [EL] Αριδα τριβέλας
 • [HR] Burgije za motorna bušilica za zemlju • [FR] Forage terrestre • [IT] Trapano a terra • [ES] Tera borilo • [PT] Broca à abre-buracos

| Art. № | size | barcode |
|--------------------|------------|---------------|
| 110267 for RD-EA01 | Ø100x820mm | 3800123174889 |



| Art. № | size | barcode |
|--------------------|------------|---------------|
| 110268 for RD-EA01 | Ø150x820mm | 3800123174896 |



| Art. № | size | barcode |
|--------------------|------------|---------------|
| 110269 for RD-EA01 | Ø200x820mm | 3800123174902 |



ANTI VIBRATION SYSTEM FOR EARTH AUGER

• [BG] Приставка антивибрационна за моторен свредел • [RO] Cuplaj antivibratii pentru motoburghiu • [SR] Opruga za motorna bušilica zemlje • [MK] Пружина за моторна дупчалка • [RU] Пружина для сверло земли газolina • [SL] Vzmet za vrtalnik za zemljo • [EL] Ελατήριο τριβέλα - γεωτρύπανο βενζίνης • [HR] Opruge za motorna bušilica za zemlju • [FR] Ressort pour perceuse à essence
 • [IT] Molla per trapano benzina a terra • [ES] Printempo por grunda benzino borilo • [PT] Sistema anti-vibração p/ abre buracos



| Art. № | size | barcode |
|----------------|----------|---------------|
| 110270 RD-EA01 | Ø20x20mm | 3800123174957 |



ELECTRIC SNOW THROWER

• [BG] Електрически снегорин • [RO] Plug de zapada • [SR] Čistač za sneg električni • [MK] Чистач за снег електрични • [RU] Снегоуборщик электрический • [SL] Električna snežna freza • [EL] Ηλεκτρικό Εκχιονιστικό • [HR] Freza za snijeg • [FR] Souffleuse à neige électrique • [IT] Spazzaneve elettrico • [ES] Elektra jetaja neĝo • [PT] Limpa-neves elétrico



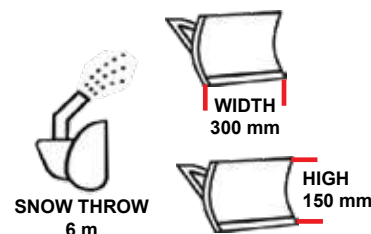

RD-ST01

| | | |
|---|---|---|
| 230V~ 50Hz | 1300 W | |
| 4000 min ⁻¹ |  |  |
|  | 5.00 kg |  |



| Art.No | gross weight | barcode |
|--------|--------------|---------------|
| 095105 | 6.000 kg | 3800123174094 |

RD-ST02

| | | |
|---|---|---|
| 230V~ 50Hz | 1300 W | |
| 3000 min ⁻¹ |  |  |
|  | 11.00 kg |  |

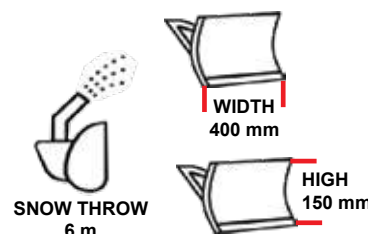

| Art.No | gross weight | barcode |
|--------|--------------|---------------|
| 095106 | 12.000 kg | 3800123174100 |

GASOLINE SNOW THROWER

• [BG] Бензинов снегорин • [RO] Plug de zapada pe benzină • [SR] Benzinska snovflake • [MK] Бензински снег • [RU] Бензиновый снегоочиститель • [SL] Bencin za sneg • [EL] Γερανός χιονιού βενζίνης • [HR] Bacač snijega za benzin • [FR] Souffleuse à essence • [IT] Benzina spazzaneve • [ES] Benzina jetilo • [PT] Limpa-neves a gasolina





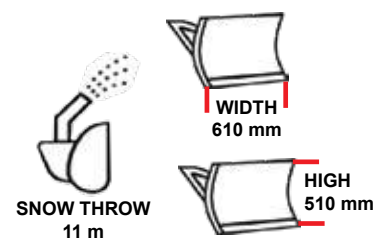





RD-GST03

| | | |
|---|---|---|
|  | 4.1 kW | 3600 min ⁻¹ |
|  | 510 mm |  |
|  |  |  |
|  | 50.00 kg |  |



| Art.No | gross weight | barcode |
|--------|--------------|---------------|
| 076901 | 54.000 kg | 3800972003439 |

RD-GST04

| | | | | |
|---|---|---|---|---|
|  | 5.2 kW | 3600 min ⁻¹ |  |  |
|  | 510 mm |  |  | |
|  |  |  | | |
|  | 92.00 kg |  | | |



ELECTRIC STARTER



HEATED HAND GRIP



TWO STAGE SYSTEM

Self propelled

| Art.No | gross weight | barcode |
|--------|--------------|---------------|
| 076902 | 113.000 kg | 3800972003446 |



GRASS TRIMMER

• [BG] Косачка-тример • [RO] Trimmer pentru iarba • [SR] Trimer za travu • [MK] Косилка за трава [RU] Электрический триммер • [SL] Električni obrezovalnik trave • [EL] Ηλεκτρικό χορτοκοπτικό
 • [HR] Trimer za travu • [FR] Trimmer électrique • [IT] Trimmer elettrico • [ES] Herbo tondilo • [PT] Aparador de relva

RD-GT26



**CUTTING
DIAMETER
220 mm**

| Art.No | gross weight | in cartoon | barcode |
|--------|--------------|------------|---------------|
| 075544 | 1.500 kg | 15 pcs | 3800972009431 |

RD-GT11Q



**CUTTING
DIAMETER
250 mm**

| Art.No | gross weight | in cartoon | barcode |
|--------|--------------|------------|---------------|
| 075507 | 2.200 kg | 8 pcs | 3800123163173 |

RD-GT21



**CUTTING
DIAMETER
300 mm**

| Art.No | gross weight | in cartoon | barcode |
|--------|--------------|------------|---------------|
| 075525 | 3.230 kg | 4 pcs | 3800123174155 |

ELECTRIC BRUSH CUTTER WITH TRIMMER HEAD DETACHABLE SHAFT RD-EBC03

- [BG] Коса електрическа с корда • [RO] Trimmer pentru gazon • [SR] Trimer za travu
- [MK] Рачна косилка електрична • [RU] Электрический триммер - газонокосилка • [SL] Električna kosa
- [EL] Θαμνοκοπτικό ηλεκτρικό [HR] Motorna kosa • [FR] Trimmer électrique • [IT] Trimmer elettrico
- [ES] Herbo tondilo • [PT] Roçadora elétrica

| | | |
|---------------|------------|---------------------------|
| 230V~ 50Hz | 1000 W | 7300 min ⁻¹ |
| 350mm | 5.00 kg | COLOR BOX |



**CUTTING
DIAMETER
350 mm**

| Art.No | gross weight | in cartoon | barcode |
|--------|--------------|------------|---------------|
| 075526 | 5.700 kg | 4 pcs | 3800123174162 |

ELECTRIC BRUSH CUTTER WITH BLADE AND TRIMMER HEAD AND DETACHABLE SHAFT

- [BG] Коса електрическа с нож и корда съваема • [RO] Trimmer pentru gazon • [SR] Trimer za travu
- [MK] Рачна косилка електрична • [RU] Электрический триммер - газонокосилка • [SL] Električna kosa
- [EL] Θαμνοκοπτικό ηλεκτρικό με λαβή • [HR] Motorna kosa • [FR] Débroussaillieuse électrique
- [IT] Decespugliatore elettrico • [ES] Elektra trançilo • [PT] Roçadora elétrica

RD-EBC02

| | | |
|-----------------------|-----------|-------------|
| 230V~ 50Hz | 1200 W | 255mm |
| 5000min ⁻¹ | 420mm | 6.200 kg |
| 420mm | COLOR BOX | |



**CUTTING
DIAMETER
WITH CORD
420 mm**



**CUTTING
DIAMETER
WITH BLADE
255 mm**

| Art.No | gross weight | in cartoon | barcode |
|--------|--------------|------------|---------------|
| 075517 | 6.700 kg | 4 pcs | 3800123171413 |

RD-EBC05

**NEW
PRODUCT**

| | | |
|-----------------------|-----------|-------------|
| 230V~ 50Hz | 1200 W | 255mm |
| 5500min ⁻¹ | 420mm | 5.200 kg |
| 420mm | COLOR BOX | |



**CUTTING
DIAMETER
WITH CORD
255 mm**



**CUTTING
DIAMETER
WITH BLADE
255 mm**

| Art.No | gross weight | in cartoon | barcode |
|--------|--------------|------------|---------------|
| 075546 | 5.750 kg | 4 pcs | 3800972015388 |

RD-EBC06

**NEW
PRODUCT**

| | | |
|-----------------------|-----------|-------------|
| 230V~ 50Hz | 1200 W | 420mm |
| 5500min ⁻¹ | 420mm | 6.450 kg |
| 420mm | COLOR BOX | |



**CUTTING
DIAMETER
WITH CORD
420 mm**



**CUTTING
DIAMETER
WITH BLADE
420 mm**

| Art.No | gross weight | barcode |
|--------|--------------|---------------|
| 075547 | 7.000 kg | 3800972015395 |

RD-EBC07



**NEW
PRODUCT**



**CUTTING
DIAMETER
420 mm**

| Art.No | gross weight | barcode |
|--------|--------------|---------------|
| 075548 | 7.300 kg | 3800072015401 |

GASOLINE BRUSH CUTTER WITH BLADE AND TRIMMER HEAD

- [BG] Коса бензинова с нож и корда сгъваема • [RO] Motocoasa pe benzina • [SR] Motorni trimer za travu [MK] Бензински тример
- [RU] Бензиновый триммер - газонокосилка • [SL] Motorna kosa • [EL] Βενζινη Θομνοκοπτικό • [HR] Motorna kosa
- [FR] Débroussaillieuse à essence avec lame et tête de coupe [IT] Decespugliatore a benzina con lama e testina
- [ES] Trançilo por brulajo kun klingo kaj tondilo • [PT] Roçadora a gasolina

RD-GBC08



• Двигател: Едноцилиндров, бензинов, двутактов с въздушно охлаждане
• Engine type: Air cooling, single cylinder, two stroke

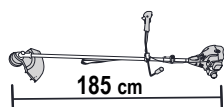

**CUTTING
DIAMETER
WITH CORD
440 mm**



**CUTTING
DIAMETER
WITH BLADE
255 mm**

| Art.No | gross weight | barcode |
|--------|--------------|---------------|
| 075504 | 9.420 kg | 3800123162770 |

RD-GBC07S

- Двигател: Едноцилиндров, бензинов, двутактов с въздушно охлаждане
• Engine type: Air cooling, single cylinder, two stroke

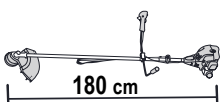
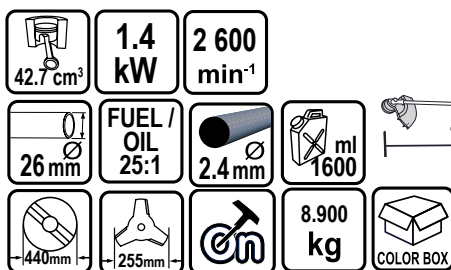

**CUTTING
DIAMETER
WITH CORD
440 mm**



**CUTTING
DIAMETER
WITH BLADE
255 mm**

| Art.No | gross weight | barcode |
|--------|--------------|---------------|
| 097102 | 10.000 kg | 3800123161292 |

RD-GBC22

- Двигател: Едноцилиндров, бензинов, двутактов с въздушно охлаждане
• Engine type: Air cooling, single cylinder, two stroke

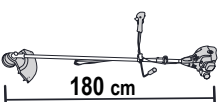

**NEW
PRODUCT**



**CUTTING
DIAMETER
WITH CORD
440 mm**





**CUTTING
DIAMETER
WITH BLADE
255 mm**

| Art.No | gross weight | barcode |
|--------|--------------|---------------|
| 075549 | 19.000 kg | 3800972015463 |

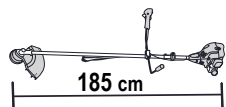
RD-GBC10



| | | |
|--|---|--|
|  42.7 cm ³ | 1.5 kW | 2 800 min⁻¹ |
|  26 mm | FUEL / OIL 25:1 |  2.4 mm |
|  440mm |  255mm |  8 kg |

• Двигател: Едноцилиндров, бензинов, двутактов с въздушно охлаждане
 • Engine type: Air cooling, single cylinder, two stroke



| Art.No | gross weight | in cartoon | barcode |
|--------|--------------|------------|---------------|
| 075510 | 9.160 kg | 2 pcs | 3800123166433 |

RD-GBC20

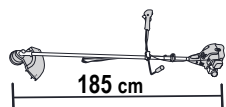

| | | |
|--|---|--|
|  52 cm ³ | 1.8 kW | 8 800 min⁻¹ |
|  24 mm | FUEL / OIL 25:1 |  2.4 mm |
|  440mm |  255mm |  8.500 kg |





• Двигател: Едноцилиндров, бензинов, двутактов с въздушно охлаждане
 • Engine type: Air cooling, single cylinder, two stroke

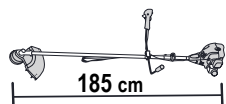

| Art.No | gross weight | in cartoon | barcode |
|--------|--------------|------------|---------------|
| 075543 | 9.340 kg | 2 pcs | 3800972009035 |

RD-GBC14



| | | |
|--|---|--|
|  52 cm ³ | 1.8 kW | 2 800 min⁻¹ |
|  26 mm | FUEL / OIL 25:1 |  2.4 mm |
|  440mm |  255mm |  9.000 kg |

• Двигател: Едноцилиндров, бензинов, двутактов с въздушно охлаждане
 • Engine type: Air cooling, single cylinder, two stroke



| Art.No | gross weight | in cartoon | barcode |
|--------|--------------|------------|---------------|
| 075534 | 9.950 kg | 2 pcs | 3800123174247 |

RDP-GBC15

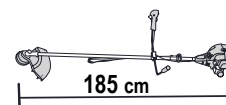

| | | |
|--|---|---|
|  52 cm ³ | 1.8 kW | 7 500 min⁻¹ |
|  28 mm | FUEL / OIL 25:1 |  2.4 mm |
|  440mm |  255mm |  11.000 kg |

• Двигател: Едноцилиндров, бензинов, двутактов с въздушно охлаждане
 • Engine type: Air cooling, single cylinder, two stroke



RAIDER® Pro

EasyOn

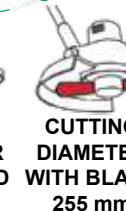

| Art.No | gross weight | in cartoon | barcode |
|--------|--------------|------------|---------------|
| 075535 | 11.940 kg | | 3800123174384 |

RDP-GBC21

NEW PRODUCT

• Двигател: Едноцилиндров, бензинов, двутактов с въздушно охлаждане
• Engine type: Air cooling, single cylinder, two stroke

| | | | |
|--|--|--|--|
|  54 cm ³ | 2.2 kW | 3 000 min⁻¹ |  185 cm |
|  28 mm | FUEL / OIL 25:1 |  2.4 mm |  ml 800 |
|  440 mm |  255 mm |  | 4.5 kg |
|  COLOR BOX | | | |



RAIDER[®] Pro
EasyOn



CUTTING DIAMETER WITH CORD
440 mm



CUTTING DIAMETER WITH BLADE
255 mm

| Art.No | gross weight | in cartoon | barcode |
|--------|--------------|------------|---------------|
| 075550 | 5.150 kg | | 3800972015470 |

RD-GBC11

4 STROKE ENGINE

• Двигател: Едноцилиндров, бензинов, четиритактов с въздушно охлаждане
• Engine type: Air cooling, single cylinder, four stroke

| | | | |
|---|--|--|---|
|  40 cm ³ | 0.8 kW | 3 000 min⁻¹ |  176 cm |
|  700 gr |  26 mm |  2.4 mm |  ml 1600 |
|  440 mm |  255 mm |  | 8.00 kg |
|  COLOR BOX | | | |



CUTTING DIAMETER WITH CORD
440 mm







CUTTING DIAMETER WITH BLADE
255 mm

| Art.No | gross weight | barcode |
|--------|--------------|---------------|
| 075513 | 8.880 kg | 3800123171246 |

POLE SAW HEAD WITH TUBE FOR GASOLINE BRUSH CUTTER RD-GBC10, GBC11 AND GBC20

[BG] Кастрачка за бензинова коса • [RO] Cap d'ubija prelungitor pentru motocoasa • [SR] Lančana testera za grane • [MK] Верижна пила за гранки • [RU] Пила для обрезки ветвей для • [SL] Verižna žaga za veje • [EL] Αλυσσπρίνο κονταρίου μπαταρίας • [HR] Teleskopska pila za motorna kosa • [FR] Scie pour branches de taille pour • [IT] Visto per i rami di potatura per • [ES] Vidis por rikoltitiloj • [PT] Serra de podar c/ tubo p/ corta-sebas a gasolina

| | | |
|---|---|--|
|  10" 250mm |  AUTO |  0.50"(1.3mm) |
| 1.300 kg |  COLOR BOX | |





| Art.No | gross weight | in cartoon | barcode |
|--------|--------------|------------|---------------|
| 110216 | 2.000 kg | | 3800123161377 |

CHAIN FOR POLE SAW RD-GBC10, GBC11 AND GBC20

[BG] Верига за кастрачка • [RO] Lant pentru ferestrau el. cu lant • [SR] Lanac za lančanu testeru za grane • [MK] Ланец за верижна пила за гранки • [RU] Цепь для пила обрезки ветвей • [SL] Veriga za žaga za veje • [EL] Αλυσίδα αλυσσπρίνο κονταρίου μπαταρίας • [HR] Lanac za teleskopska pila • [FR] Chaîne pour tronçonner les branches • [IT] Catena per rami di taglio sega • [ES] Čeno por segbetbrancoj • [PT] Corrente moto-serra



| | |
|---|--|
|  10" 250mm |  0,50"(1,3mm) |
|---|--|

| Art.No | gross weight | in cartoon | barcode |
|--------|--------------|------------|---------------|
| 140111 | 0.130 kg | 50 pcs | 3800123166662 |

GUIDE BAR FOR POLE SAW RD-GBC10, GBC11 AND GBC20

[BG] Водеща шина за кастрачка • [RO] Lama ghidaj pentru ferestrau el. cu lant • [SR] Vodič lanca za lančanu testeru za grane • [MK] Водич за ланец за пила за гранки • [RU] Направляющая шина для пила обрезки ветвей • [SL] Meč za veriga za žaga za veje • [EL] Λαμα για αλυσσπρίνο κονταρίου μπαταρίας • [HR] Vodilica za teleskopska pila • [FR] Pneu de guidage pour la coupe de scie • [IT] Pneumatico di guida per taglio di seghe • [ES] Gvidu pneúo por segcincigilo • [PT] Guia de corte p/motoserra



| | |
|---|---|
|  10" 250mm |  0,50"(1,3mm) |
|---|---|

| Art.No | gross weight | in cartoon | barcode |
|--------|--------------|------------|---------------|
| 141303 | 0.390 kg | 20 pcs | 3800123166679 |

HEDGE TRIMMER HEAD AND TUBE FOR GASOLINE BRUSH CUTTER RD-GBC10, RD-GBC11

[BG] Ръзачка за храсти за бензинова коса • [RO] Trimmer pt. gard viu • [SR] Trimer za zivu ogradu • [MK] Косилка за жива ограда • [RU] Садовые ножницы-кусторезы • [SL] Škarje za živo mejo • [EL] Φολίδι μπортουρας • [HR] Glava i cijev za rezanje živice za rezač četke za benzin • [FR] Tête et tube de taille-haie pour débroussailluse à essence • [IT] Testina tagliasiepi e tubo per decespugliatore a benzina • [ES] Štranča kapo kaj tubo • [PT] Cabeça corta-sebes p/ roçadora a gasolina



| Art.No | gross weight | barcode |
|--------|--------------|---------------|
| 110272 | 2.620 kg | 3800972001732 |

TILLER ATTACHMENT FOR GASOLINE BRUSH CUTTER

[BG] Фреза за бензинова коса • [RO] Sapatoare pentru motocoasa • [SR] Glodalica za benzin • [MK] Секач за мелење на бензин • [RU] Бензиновый фрезер • [SL] Bencinski rezkaro • [EL] Φρεζάρισμα φρεζάρισμα βενζίνης • [HR] Rezač benzina • [FR] Fraise à essence • [IT] Fresa per benzina • [ES] Muelanta kurtenon • [PT] Fresa a gasolina



| Art.No | size | gross weight | barcode |
|--------|-------|--------------|---------------|
| 110288 | 320mm | 1.500 kg | 3800972015494 |

EXTENSION POLE FOR GASOLINE BRUSH CUTTER

[BG] Удължение за бензинова коса • [RO] Tijă extensie pentru motocoasa • [SR] Produžetak za kosu sa benzinom • [MK] Продолжување за бензинска коса • [RU] Наравивание для бензиновых фрезер • [SL] Bencinski rezkaro • [EL] Επέκταση για μαλλιά βενζίνης • [HR] Produžetak za benzinsku kosu • [FR] Extension pour cheveux à essence • [IT] Estensione per capelli benzina • [ES] Etendaño por benzina haroj • [PT] Extensão para cabelos a gasolina



| Art.No | size | gross weight | barcode |
|--------|------|--------------|---------------|
| 110289 | 1m | 0.900 kg | 3800972015500 |



POLE SAW RD-PS01

[BG] Кастрачка • [RO] Fierastrau electric telescopic de taiat crengi • [SR] Lančana testera za grane • [MK] Верижна пила за гранки • [RU] Пила для обрезки ветвей • [SL] Verižna žaga za veje • [EL] Αλυσοπρίοιο κονταριού μπαταρίας • [HR] Teleskopska pila za motorna kosa • [FR] Scie pour branches de taille pour • [IT] Visto per i rami di potatura per • [ES] Vidis por rikoltiloj • [PT] Serra de podar corta-sebes a gasolina

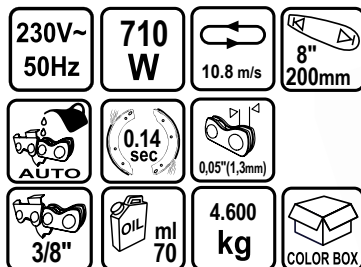
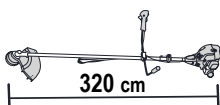

| Art.No | gross weight | in cartoon | barcode |
|--------|--------------|------------|---------------|
| 075703 | 6.670 kg | 2 pcs | 3800123163784 |

CHAIN FOR POLE SAW FOR RD-PS01

[BG] Верига за кастрачка • [RO] Lant pentru ferestrau el. cu lant • [SR] Lanac za lančanu testeru za grane • [MK] Ланец за верижна пила за гранки • [RU] Цепь для пила обрезки ветвей • [SL] Veriga za žaga za veje • [EL] Αλυσίδα αλυσοπίρινο κονταριού μπαταρίας • [HR] Lanac za teleskopska pila • [FR] Chaîne pour tronçonner les branches • [IT] Catena per rami di taglio sega • [ES] Čeno por segčetbrančoj • [PT] Corrente moto-serra



| Art.No | gross weight | in cartoon | barcode |
|--------|--------------|------------|---------------|
| 140110 | 0.120 kg | 50 pcs | 3800123163791 |

GUIDE BAR FOR POLE SAW FOR RD-PS01

[BG] Водеща шина за кастрачка • [RO] Lama ghidaj pentru ferestrau el. cu lant • [SR] Vodič lanca za lančanu testeru za grane • [MK] Водич за ланец за пила за гранки • [RU] Направляющая шина для пила обрезки ветвей • [SL] Meč za veriga za žaga za veje • [EL] Λαμα για αλυσοπίρινο κονταριού μπαταρίας • [HR] Vodilica za teleskopska pila • [FR] Pneu de guidage pour la coupe de scie • [IT] Pneumatico di guida per taglio di seghe • [ES] Gvidu pneūo por segcinigilo • [PT] Guia de corte p/motoserra



| Art.No | gross weight | in cartoon | barcode |
|--------|--------------|------------|---------------|
| 141302 | 0.310 kg | 10 pcs | 3800123163807 |



LAWN MOWER

[BG] Косачка • [RO] Masina de tuns iarba • [SR] Kosачice za travu • [MK] Косилка за трава • [RU] Электрическая газонокосилка • [SL] Električna kosilnica • [EL] ηλεκτρική μηχανή γκαζόν • [HR] Električna kosilica • [FR] Tondeuse à gazon • [IT] Tosaerba elettrico • [ES] Gazontondilo • [PT] Corta relvas

RD-LM30

230V~
50Hz

1200
W

**NEW
PRODUCT**



3700
min⁻¹



20-40-60mm

6.5
kg



m² 400



| Art.No | gross weight | barcode |
|--------|--------------|---------------|
| 075330 | 7.600 kg | 3800972015517 |

BLADE 320MM FOR RD-LM30

| Art.No | barcode |
|--------|---------------|
| 110294 | 3800972019485 |



RD-LM35

230V~
50Hz

1300
W

**NEW
PRODUCT**



3700
min⁻¹



25-55 mm

8
kg



m² 400



| Art.No | gross weight | barcode |
|--------|--------------|---------------|
| 075335 | 8.850 kg | 3800972015654 |

BLADE 320MM FOR RD-LM35

| Art.No | barcode |
|--------|---------------|
| 110299 | 3800972019539 |



RD-LM 31

NEW PRODUCT

| | |
|---------------|---------------------------|
| 230V~ 50Hz | 1400 W |
| 330mm | 3400 min ⁻¹ |
| 30L | 20-40-60mm |
| 7.2 kg | COLOR BOX |

m² 500



| Art.No | gross weight | barcode |
|--------|--------------|---------------|
| 075331 | 8.400 kg | 3800972015524 |



BLADE FOR RD-LM31

| Art.No | barcode |
|--------|---------------|
| 110295 | 3800972019492 |

RD-LM 32

NEW PRODUCT

| | |
|---------------|---------------------------|
| 230V~ 50Hz | 1600 W |
| 360mm | 3500 min ⁻¹ |
| 40L | 25-55mm |
| 12 kg | COLOR BOX |

m² 700



| Art.No | gross weight | barcode |
|--------|--------------|---------------|
| 075332 | 12.500 kg | 3800972015531 |



BLADE FOR RD-LM32

| Art.No | barcode |
|--------|---------------|
| 110296 | 3800972019508 |

SET LAWN MOWER AND GRASS TRIMMER RD-LMGT01

[BG] Комплект косачка и триммер • [RO] Masina de tuns iarba & trimmer • [SR] Kosilica za travu & trimer • [MK] Косилка & тример • [RU] Косилка за трава и триммера • [SL] kosilnica & trimer • [EL] Μηχανή γκαζόν • [HR] Kosačice za travu & trimer • [FR] Tondeuse à gazon & trimer • [IT] Tosaerba elettrico & Trimer • [ES] Gazontondilo & trimer • [PT] Kit corta relvas e corta sebes

LAWN MOWER

| | | |
|---------------|-----------|---------------------------|
| 230V~ 50Hz | 1600 W | 3500 min ⁻¹ |
| 360mm | 35L | |
| 25-55mm | 12 kg | COLOR BOX |

GRASS TRIMMER

| | | |
|---------------|----------|------------------------|
| 230V~ 50Hz | 250 W | 12000min ⁻¹ |
| 220mm | 1.2mm | 1.200 kg |
| | | COLOR BOX |



| Art.No | gross weight | barcode |
|--------|--------------|---------------|
| 075327 | 13.500 kg | 3800972009424 |

LAWN MOWER

[BG] Косачка • [RO] Masina de tuns iarba • [SR] Kosačice za travu • [MK] Косилка за трава • [RU] Электрическая газонокосилка • [SL] Električna kosilnica • [EL] ηλεκτρική μηχανή γκαζόν • [HR] Električna kosilica • [FR] Tondeuse à gazon • [IT] Tosaerba elettrico • [ES] Gazontondilo • [PT] Corta relvas

RD-LM33

NEW PRODUCT

| | | |
|---------------|--------------|---------------------------|
| 230V~ 50Hz | 1800 W | 3300 min ⁻¹ |
| 380mm | 50L | |
| 20-70mm | 10.950 kg | COLOR BOX |

m² 800

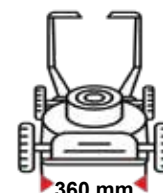

| Art.No | gross weight | barcode |
|--------|--------------|---------------|
| 075333 | 13.200 kg | 3800972015548 |



BLADE FOR RD-LM33

| Art.No | barcode |
|--------|---------------|
| 110295 | 3800972019492 |

RD-LM34

**NEW
PRODUCT**

230V~
50Hz

2000
W

3300
min⁻¹

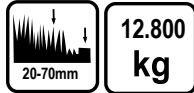

12.800
kg



m² 1000

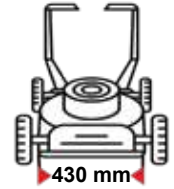

| Art.No | gross weight | barcode |
|--------|--------------|---------------|
| 075334 | 14.400 kg | 3800972015555 |

BLADE FOR RD-LM34

| Art.No | barcode |
|--------|---------------|
| 110298 | 3800972019522 |

RD-LM23

**NEW
PRODUCT**

36
V

2x4
Ah

2x18
V

3500
min⁻¹



10.200
kg



m² 500

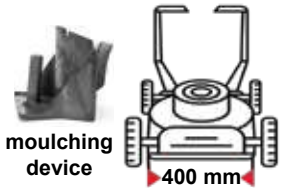

| Art.No | gross weight | barcode |
|--------|--------------|---------------|
| 075322 | 17.500 kg | 3800972003620 |

| art. No | V | BARCODE |
|---------|-----|---------------|
| 032124 | 230 | 3800972003675 |

| art. No | V | mAh | BARCODE |
|---------|----|------|---------------|
| 131147 | 18 | 4000 | 3800972003668 |



SCARIFIER AND AERATOR 2 IN 1

[BG] Аератор • [RO] Scarificator 2 in 1 • [SR] Serifikator i aerator • [MK] Скарификатор и аератор • [RU] Скарификатор и аэратор • [SL] Škarje in aerator • [EL] Διασκορπιστής και αεριστήρας • [HR] Šerifikator i aerator • [FR] Scarificateur et aérateur • [IT] Scarificatore e aeratore • [ES] Scarifier kaj aeratoro • [PT] Escarificador e aerador

RD-ESC01
**NEW
PRODUCT**
2in1

| | | |
|-------------------------------------|--|---------------------------|
| 230V~ 50Hz | 1400 W | 4200 min ⁻¹ |
| 30L | 5x CENTRAL WORKING DEPTH ADJUSTMENT | LONG LIFE BLADES 320mm |
| LONG LIFE HIGH-GRADE STEEL 320mm | 10.2 kg | COLOR BOX |

m² 1200

**LONG LIFE BLADES
320 mm**

| Art.No | gross weight | barcode |
|--------|--------------|---------------|
| 075337 | 11.200 kg | 3800972015920 |

RD-ESC02
**NEW
PRODUCT**
2in1

| | | |
|-------------------------------------|--|---------------------------|
| 230V~ 50Hz | 1600 W | 4000 min ⁻¹ |
| 50L | 5x CENTRAL WORKING DEPTH ADJUSTMENT | LONG LIFE BLADES 320mm |
| LONG LIFE HIGH-GRADE STEEL 320mm | 9.600 kg | COLOR BOX |

m² 1400

**LONG LIFE BLADES
320 mm**

| Art.No | gross weight | barcode |
|--------|--------------|---------------|
| 075338 | 11.500 kg | 3800972015937 |

SHREDDER

[BG] Клонотрошачка • [RO] Tocator frunze si crengi • [SR] Rezač grana • [MK] Уништувач за гранки • [RU] Шредер для веток • [SL] Shredder za veje • [EL] Τεμαχίζων • [HR] Shredder • [FR] Shredder • [IT] Distruttore • [ES] Shredder [PT] Destruidora

RD-ESH01



| | | |
|---------------|------------|---------------------------|
| 230V~ 50Hz | 2400 W | 4500 min ⁻¹ |
| Ø40 | 13.5 kg | |

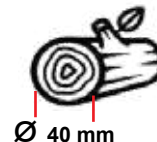

| Art.No | gross weight | barcode |
|--------|--------------|---------------|
| 075336 | 14.500 kg | 3800972015944 |

RD-ESH02



| | | |
|---------------|-----------|-------------------------|
| 230V~ 50Hz | 2800 W | 42 min ⁻¹ |
| 50 L | Ø45 | 24.600 kg |
| | | |



| Art.No | gross weight | barcode |
|--------|--------------|---------------|
| 075339 | 25.500 kg | 3800972015951 |

GASOLINE LAWN MOWER RD-GLM01S

[BG] Косачка бензинова • [RO] Motocoasa pe benzina • [SR] Kosačica benzinska • [MK] Бензинска косилка за трева • [RU] Бензиновая газонокосилка • [SL] Bencina kosilnica • [EL] Χλοοκοπτικός μηχανής γκαζόν • [HR] Motorna kosilica • [FR] Tondeuse à essence • [IT] Rasaerba a benzina • [ES] Gasolina gazono • [PT] Corta relvas a gasolina

• Двигател: Едноцилиндров, бензинов, четиритактов с въздушно охлаждане
• Engine type: Air cooling, single cylinder, four stroke

| | | |
|---------------------|------------|---------------------------|
| 125 cm ³ | 2000 W | 3600 min ⁻¹ |
| 40L | ml 1500 | 400mm |
| 25-75mm | | 15.5 kg |
| | | |

m² 900



| Art.No | gross weight | barcode |
|--------|--------------|---------------|
| 110105 | 20.080 kg | 3800123141546 |

GASOLINE LAWN MOWER SELF-PROPELLED

[BG] Косачка бензинова самоходна • [RO] Motocoasa pe benzina • [SR] Kosačica benzinska • [MK] Бензинска косилка за трева • [RU] Бензиновая газонокосилка • [SL] Bencina kosilnica • [EL] Χλοοκοπτική μηχανής γκαζόν • [HR] Motorna kosilica • [FR] Tondeuse à essence autopropulsée • [IT] Rasaerba a benzina semovente • [ES] Benzina gazetara tondilo • [PT] Corta relvas a gasolina

RD-GLM07



• Двигател: Едноцилиндров, бензинов, четиритактов с въздушно охлаждане
 • Engine type: Air cooling, single cylinder, four stroke

| | | |
|--------------------|---------------|------------------------------|
| 125cm ³ | 2000 W | 2900 min⁻¹ |
| 45L | ml 1300 | 410mm |
| 25-75mm | 24.00 kg | COLOR BOX |

m² 1200



| Art.No | gross weight | barcode |
|--------|--------------|---------------|
| 075002 | 26.000 kg | 3800972015296 |

BLADE FOR RD-GLM07

| Art.No | barcode |
|--------|---------------|
| 110300 | 3800972019546 |

RD-GLM08



• Двигател: Едноцилиндров, бензинов, четиритактов с въздушно охлаждане
 • Engine type: Air cooling, single cylinder, four stroke

4 functions in 1 machine

| | | | |
|--------------------|---------------|------------------------------|---|
| 144cm ³ | 2500 W | 2800 min⁻¹ | 8 x ↑ ↓ CENTRAL WORKING DEPTH ADJUSTMENT |
| 65L | ml 800 | 460mm | ml 500 |
| 30-80mm | 27.6 kg | COLOR BOX | |

m² 1600



| Art.No | gross weight | barcode |
|--------|--------------|---------------|
| 075003 | 31.200 kg | 3800972015289 |

BLADE FOR RD-GLM08

| Art.No | barcode |
|--------|---------------|
| 110301 | 3800972019553 |

RD-GLM05



• Двигател: Едноцилиндров, бензинов, четиритактов с въздушно охлаждане
 • Engine type: Air cooling, single cylinder, four stroke

4 functions in 1 machine

| | | |
|--------------------|---------------|------------------------------|
| 150cm ³ | 3200 W | 2600 min⁻¹ |
| 55L | ml 800 | 460mm |
| 25-75mm | 27 kg | COLOR BOX |

m² 1600



| Art.No | gross weight | barcode |
|--------|--------------|---------------|
| 075318 | 30.030 kg | 3800123174575 |

RD-GLM09

NEW PRODUCT

4 functions in 1 machine

| | | | |
|--------------------|---------------|------------------------------|---|
| 196cm ³ | 3200 W | 2800 min⁻¹ | 65L |
| ml 850 | 510mm | ml 450 | 8x ↑ ↓ CENTRAL WORKING DEPTH ADJUSTMENT |
| 30-80mm | | 34 kg | COLOR BOX |

4in1
m² 1900



• Двигател: Едноцилиндров, бензинов, четиритактов с въздушно охлаждане
• Engine type: Air cooling, single cylinder, four stroke

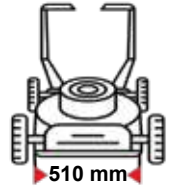

| Art.No | gross weight | barcode |
|--------|--------------|---------------|
| 075004 | 38.000 kg | 3800972015302 |

BLADE FOR RD-GLM09

| Art.No | barcode |
|--------|---------------|
| 110302 | 3800972019560 |

RD-GLM10

NEW PRODUCT

5 functions in 1 machine

| | | | |
|--------------------|---------------|------------------------------|---|
| 196cm ³ | 3200 W | 2800 min⁻¹ | 70L |
| ml 850 | 530mm | ml 450 | 8x ↑ ↓ CENTRAL WORKING DEPTH ADJUSTMENT |
| 25-55mm | | 37 kg | COLOR BOX |

5in1
m² 2500



• Двигател: Едноцилиндров, бензинов, четиритактов с въздушно охлаждане
• Engine type: Air cooling, single cylinder, four stroke

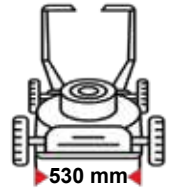

| Art.No | gross weight | barcode |
|--------|--------------|---------------|
| 075005 | 40.000 kg | 3800972015319 |

RD-GLM11 SOLO

NEW PRODUCT

• Двигател: Едноцилиндров, бензинов, четиритактов с въздушно охлаждане
• Engine type: Air cooling, single cylinder, four stroke

5 functions in 1 machine

| | | | |
|--------------------|---------------|------------------------------|---|
| 173cm ³ | 3700 W | 2800 min⁻¹ | 70L |
| ml 850 | 530mm | ml 450 | 8x ↑ ↓ CENTRAL WORKING DEPTH ADJUSTMENT |
| 25-75mm | | 38 kg | COLOR BOX |

5in1
m² 2500



| Art.No | gross weight | barcode |
|--------|--------------|---------------|
| 075006 | 40.000 kg | 3800972015326 |

RD-GLM12

NEW PRODUCT

• Двигател: Едноцилиндров, бензинов, четиритактов с въздушно охлаждане
• Engine type: Air cooling, single cylinder, four stroke

5 functions in 1 machine

| | | | |
|--------------------|---------------|------------------------------|---|
| 173cm ³ | 3700 W | 2800 min⁻¹ | 70L |
| ml 1300 | 560mm | ml 600 | 8x ↑ ↓ CENTRAL WORKING DEPTH ADJUSTMENT |
| 30-90mm | | 39 kg | COLOR BOX |

5in1
m² 3000



| Art.No | gross weight | barcode |
|--------|--------------|---------------|
| 075007 | 41.000 kg | 3800972015333 |

BLADE FOR RD-GLM12

| Art.No | barcode |
|--------|---------------|
| 110303 | 3800972019577 |

SICKLE BAR GASOLINE MOWER RD-SBM01

[BG] Косачка бензинова палцова • [RO] Motocositoare • [SR] Kosačica benzinska • [MK] Бензинска косилка за трева
 • [RU] Бензиновая газонокосилка • [SL] Bencina kosilnica • [EL] Χλοοκοπτικός μηχανής γκαζόν • [HR] Motorna kosilica
 • [FR] Tondeuse à essence autopropulsée • [IT] Rasaerba a benzina semovente • [ES] Benzina gazetara tondilo • [PT] Corta relvas a gasolina

NEW PRODUCT

• Двигател: Едноцилиндров, бензинов, четритактов с въздушно охлаждане
 • Engine type: Air cooling, single cylinder, four stroke

m² 3000

| Art.No | gross weight | barcode |
|--------|--------------|---------------|
| 075008 | 67.500 kg | 3800972015340 |

GASOLINE SCARIFIER RD-GSC03

[BG] Аератор бензинов • [RO] Scarificator pe benzina • [SR] Serifikator i aerator
 • [MK] Скарификатор и аератор • [RU] Скарификатор и аэратор
 • [SL] Škarje in aerator • [EL] Διασκορπιστής και αεριστήρας
 • [HR] Šerifikator i aerator • [FR] Scarificateur et aérateur • [IT] Scarificatore e aeratore
 • [ES] Scarifier kaj aeratoro • [PT] Escarificador e aerador

NEW PRODUCT

• Двигател: Едноцилиндров, бензинов, четритактов с въздушно охлаждане
 • Engine type: Air cooling, single cylinder, four stroke

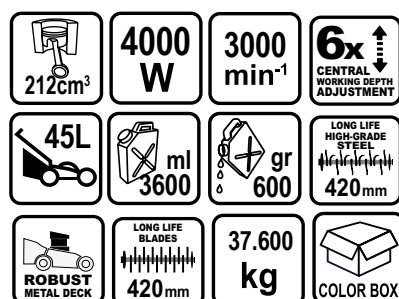

m² 2000

| Art.No | gross weight | in cartoon | barcode |
|--------|--------------|------------|---------------|
| 075009 | 40.000 kg | | 3800972015357 |

CORDLESS GRASS AND SHRUB SHEARS

[BG] Ножица за трева и храсти акумулаторна • [RO] Foarfeca iarba si arbusti cu acumulator [SR] Akumulatorske makaze za travu i živu ogradu • [MK] Акумулаторски ножици за трева и жива ограда • [RU] Акумулаторные ножницы-кусторезы • [SL] Akumulatorski škarje za živo mejo • [EL] Ψαλίδι ιμportιουρας ιμταταριας • [HR] Akumulatorske škare za travu i živicu • [FR] Cisailles à gazon et arbustes sans fil • [IT] Cesioie per erba e cesioie a batteria
 • [ES] Sendrataj tondiloj de herbo kaj arbusto • [PT] Corta-sebas a bateria

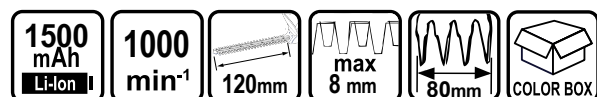
| Art.No | V | weight | gross weight | in cartoon | barcode |
|------------------|-----|----------|--------------|------------|---------------|
| 075531 RD-GSSL01 | 3.6 | 1.200 kg | 1.160 kg | 10 pcs | 3800123174216 |
| 075532 RD-GSSL02 | 7.2 | 1.400 kg | 1.200 KG | 10 pcs | 3800123174223 |



HEDGE TRIMMER

[BG] Рязачка за храсти • [RO] Trimmer pt. gard viu • [SR] Trimer za zivu ogradu • [MK] Косилка за жива ограда • [RU] Садовые ножницы-кусторезы • [SL] Škarje za živo mejo • [EL] Ψαλίδι Μπορντούρας Ηλεκτρικό • [HR] Električne škare za živicu • [FR] Taille-haie • [IT] Tagliasiepi • [ES] Heğdezurilo • [PT] Costa-sebes

RD-HT06

| | |
|---------------------------|-----------|
| 230V~ 50Hz | 550 W |
| 1500 min ⁻¹ | 510mm |
| max 20 mm | 2 kg |
| | COLOR BOX |



LENGHT 510 mm

| Art.No | gross weight | in cartoon | barcode |
|--------|--------------|------------|---------------|
| 075706 | 2.880 kg | 4 pcs | 3800123174872 |

RD-HT05

| | |
|---------------------------|-----------|
| 230V~ 50Hz | 710 W |
| 1700 min ⁻¹ | 610mm |
| max 24 mm | 4 kg |
| | COLOR BOX |

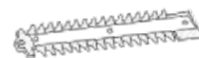

LENGHT 610 mm



ROTATABLE
HANDLE



ERGONOMIC
HANDLE

| Art.No | gross weight | in cartoon | barcode |
|--------|--------------|------------|---------------|
| 075705 | 4.130 kg | 4 pcs | 3800123174834 |

GASOLINE HEDGE TRIMMER RD-GHT02

[BG] Рязачка за храсти бензинова • [RO] Trimmer pt. gard viu • [SR] trimer za zivu ogradu • [MK] Косилка за жива ограда • [RU] Садовые ножницы-кусторезы • [SL] škarje za živo mejo • [EL] Ψαλίδι Μπορντούρας • [HR] Benzinske škare za živicu • [FR] Taille-haie • [IT] Tagliasiepi • [ES] Heğdezurilo • [PT] Corta-sebes a gasolina

| | | | |
|-----------------------|--------------|---------------------------|--|
| 22.5 cm ³ | 650 W | 6500 min ⁻¹ | |
| FUEL / OIL 25:1 | ml 500 | 6.7 kg | |
| 600mm | max 23 mm | COLOR BOX | |



ROTATABLE
HANDLE

| Art.No | gross weight | barcode |
|--------|--------------|---------------|
| 075702 | 7.250 kg | 3800123161384 |

KNAPSACK SPRAYER RD-BKMD03

[BG] Прыскачка • [RO] Vermorel • [SR] Prskalica • [MK] Пумпа прскалка • [RU] Рюкзак опрыскиватель • [SL] Škropilnica • [EL] Ψεκαστήρας σακιδίου • [HR] Prskalica • [FR] Pulvérisateur à dos • [IT] Spruzzatore a zaino • [ES] Pulverizador mochila • [PT] Pulverizador manual

NEW PRODUCT

BATTERY & CHARGER INCLUDED

| | |
|---------------------|-----------------|
| 12 V | 10 Ah |
| max. 0.62 MPa | 0.2-0.45 MPa |
| | 16 L |
| LIQUID ≥ 5 L/min | 8 m |
| 1.5 m | 7.00 kg |
| | COLOR BOX |

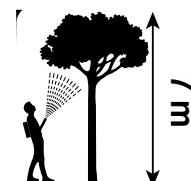







CAPACITY 16 L

| Art.No | gross weight | barcode |
|--------|--------------|---------------|
| 098102 | 7.600 kg | 3800972009226 |

KNAPSACK SPRAYER RD-BKMD04

[BG] Пръскачка • [RO] Vermorel cu carucior si port USB • [SR] Prskalica • [MK] Пумна прскалка • [RU] Рюкзак опрыскиватель [SL] Škropilnica • [EL] Ψεκαστήρας σακιδίων • [HR] Prskalica • [FR] Pulvérisateur à dos • [IT] Spruzzatore a zaino • [ES] Pulverizador mochila • [PT] Pulverizador manual

**NEW
PRODUCT**
**BATTERY & CHARGER
INCLUDED**
**TROLLEY
and
USB CHARGER
FOR MOBILE PHONE
included**

| | | |
|---|---|---|
| 12 V | 10 Ah | |
| max. 0.62 MPa | 0.2-0.45 MPa |  16 L |
|  7 m |  LIQUID ≥ 5 L/min |  8 m |
|  1.5 m | 9.00 kg |  COLOR BOX |

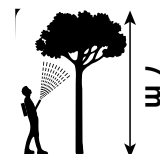









CAPACITY 16 L

| Art.No | gross weight | in cartoon | barcode |
|--------|--------------|------------|---------------|
| 098103 | 9.880 kg | | 3800972009233 |

KNAPSACK MIST DUSTER

[BG] Моторна пръскачка • [RO] Atomizor cu motor pe benzina • [SR] Prskalica ledna motorna • [MK] Пумна прскалка на бензин • [RU] Рюкзак опрыскиватель • [SL] Motorno škropilnico • [EL] Ψεκαστήρας μηχανοκίνητος • [HR] Motorna prskalica • [FR] Pulvérisateur à dos • [IT] Spruzzatore a zaino • [ES] Pulverizador mochila • [PT] Pulverizador manual











RD-KMD01J

| | | |
|--|---|---|
|  41.5 cm ³ | 2200 W | 8000 min ⁻¹ |
|  ml 2000 |  13.8m ³ /min |  20 L |
|  5 m |  12 m | FUEL / OIL 25:1 |
|  LIQUID ≥ 4 L/min |  DUST ≥ 6 L/min |  12 kg |
| | |  COLOR BOX |

CAPACITY 20 L

| Art.No | gross weight | barcode |
|--------|--------------|---------------|
| 110108 | 13.600 kg | 3800123158292 |

RD-KMD02

| | | |
|--|---|---|
|  41.5 cm ³ | 2200 W | 8000 min ⁻¹ |
|  ml 2000 |  13.8m ³ /min |  14 L |
|  10 m |  12 m | FUEL / OIL 25:1 |
|  LIQUID ≥ 4 L/min |  DUST ≥ 6 L/min |  11 kg |
| | |  COLOR BOX |

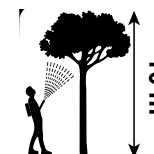
CAPACITY 14 L

| Art.No | gross weight | in cartoon | barcode |
|--------|--------------|------------|---------------|
| 098101 | 13.000 kg | | 3800123174254 |

PERIPHERAL PUMP

[BG] Помпа водна • [RO] Pompa de apa • [SR] Pumpa • [MK] Водна пумпа • [RU] Насос • [SL] Črpalka za vodo
[EL] Αντλία νερού • [HR] Pumpa za vodu • [FR] Pompe • [IT] Pompa • [ES] Bombo • [PT] Bomba periférica



L/min
35 - 070101
40 - 070115



Hmax
35 m



Smax
8 m

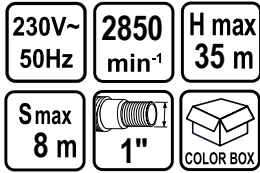

| Art.No | W | L/min | gross weight | in carton | barcode |
|----------------|-----|-------|--------------|-----------|---------------|
| 070101 RD-PK60 | 370 | 35 | 4.520 kg | 6 pcs | 3800123123887 |
| 070115 RD-WP60 | 500 | 40 | 5.170 kg | 6 pcs | 3800123141539 |



L/min
96 - 070104
120 - 070116



Hmax
28 m - 070104
35 m - 070116



Smax
8 m - 070104
9 m - 070116

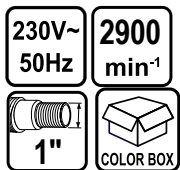

| Art.No | W | L/min | H max | S max | gross weight | in carton | barcode |
|------------------|-----|-------|-------|-------|--------------|-----------|---------------|
| 070104 RD-CPM158 | 750 | 96 | 28 | 8 | 11.800 kg | 2 pcs | 3800123123481 |
| 070116 RD-WP158 | 850 | 120 | 35 | 9 | 12.400 kg | 2 pcs | 3800123141881 |

RD-1.5DK20



L/min
210



Hmax
20 m



Smax
9 m

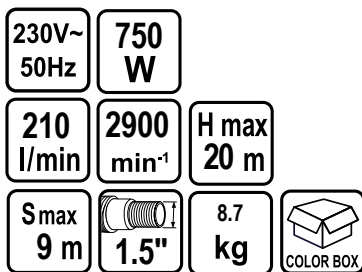

| Art.No | gross weight | barcode |
|--------|--------------|---------------|
| 070103 | 9.760 kg | 3800123123511 |

CENTRIFUGAL PUMP RD-2DK20

[BG] Помпа водна • [RO] Pompa de apa • [SR] Pumpa • [MK] Водна пумпа • [RU] Насос • [SL] Črpalka za vodo [EL] Αντλία νερού
• [HR] Pumpa za vodu • [FR] Pompe • [IT] Pompa • [ES] Bombo • [PT] Bomba periférica



L/min
500



Hmax
20 m



Smax
9 m

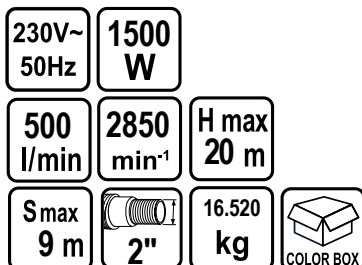



| Art.No | gross weight | barcode |
|--------|--------------|---------------|
| 070105 | 17.060 kg | 3800123123528 |

SELF-PRIMING PUMP

[BG] Помпа водна • [RO] Pompa de apa • [SR] Pumpa • [MK] Vodna pumpa • [RU] Насос • [SL] Črpalka za vodo [EL] Αντλία νερού • [HR] Pumpa za vodu • [FR] Pompe • [IT] Pompa • [ES] Bombo • [PT] Bomba periférica

RD-JET100

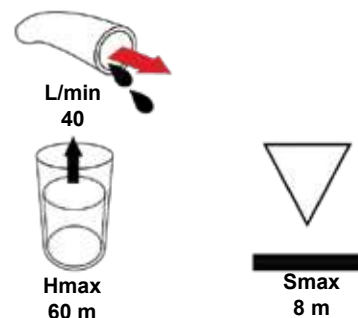

| | | |
|---------------|--|--|
| 230V~ 50Hz | 1100 W | |
| 40 l/min | 2850 min ⁻¹ | H max 60 m |
| Smax 8 m |  1" | 13.700 kg  |



| Art.No | gross weight | barcode |
|--------|--------------|---------------|
| 070117 | 14.100 kg | 3800123115875 |

RD-WP43





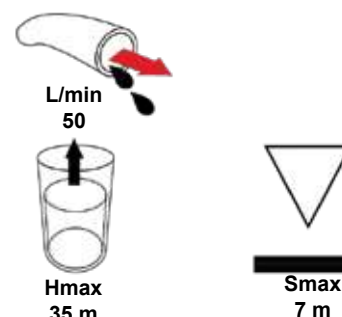

**NEW
PRODUCT**

| | | |
|---------------|--|---|
| 230V~ 50Hz | 600 W | |
| 50 l/min | 2850 min ⁻¹ | H max 35 m |
| Smax 7 m |  1" | 6.000 kg  |



| Art.No | gross weight | barcode |
|--------|--------------|---------------|
| 070151 | 6.400 kg | 3800972015753 |

RDP-WP29



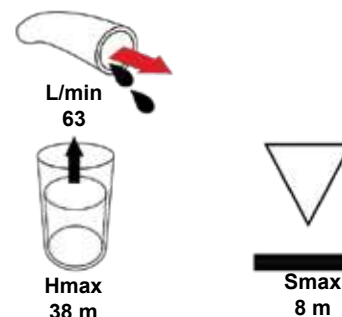



| | | |
|---|--|---|
|  230V~ 50Hz | 63 l/min | |
|  650W | H max 38 m | |
|  2850 min ⁻¹ |  1" | |
| Smax 8 m |  4.850 kg |  |
|  1 m | | |



| Art.No | gross weight | barcode |
|--------|--------------|---------------|
| 070136 | 5.200 kg | 3800123166204 |

**RAIDER®
Pro**

RDP-WP44

| | | |
|---|--|---|
|  230V~ 50Hz | 50 l/min | |
|  600W | H max 35 m | |
|  2850 min ⁻¹ |  1" | |
| Smax 7 m |  7.250 kg |  |
|  1 m | | |

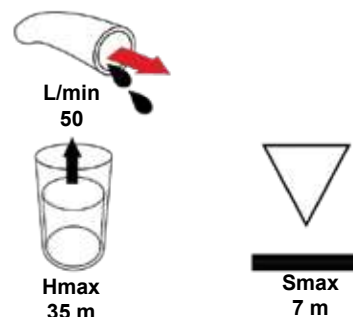



| Art.No | gross weight | barcode |
|--------|--------------|---------------|
| 070152 | 6.900 kg | 3800972015760 |

**RAIDER®
Pro**

SUBMERSIBLE PUMP FOR CLEAN WATER

[BG] Помпа водна потопяема за чиста вода • [RO] Pompa submersibila pentru apa curata • [SR] Pumpa potarajuća • [MK] Потопна пумпа • [RU] Насос Погружной • [SL] Potopna črpalčka za vodo • [EL] Υποβρύχια αντλία νερού • [HR] Potopna pumpa za čistu vodu • [FR] Pompe submersible • [IT] Pompa sommergibile • [ES] Sumergible pumpilo • [PT] Bomba submersível

RD-WP18

| | | | |
|---------------|--|---------------|---|
| 230V~ 50Hz | 300 W | | |
| 18 l/min | 2900 min ⁻¹ | H max 60 m | |
| DP max 7 m |  3/4" | 3.950 kg |  COLOR BOX |



L/min
18





Hmax
60 m



DPmax
7 m

| Art.No | gross weight | in cartoon | barcode |
|--------|--------------|------------|---------------|
| 070121 | 4.310 kg | 6 pcs | 3800123161421 |

RD-WP19

| | | | |
|---------------|--|---------------|---|
| 230V~ 50Hz | 350 W | | |
| 18 l/min | 2900 min ⁻¹ | H max 60 m | |
| DP max 7 m |  3/4" | 3.950 kg |  COLOR BOX |

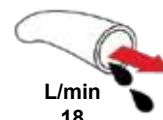

L/min
18





Hmax
60 m



DPmax
7 m

| Art.No | gross weight | in cartoon | barcode |
|--------|--------------|------------|---------------|
| 070122 | 4.430 kg | 6 pcs | 3800123161438 |

RD-WP37

| | | | |
|--|---|---------------|---|
| 230V~ 50Hz | 350 W | | |
| 50 l/min | 2900 min ⁻¹ | H max 10 m | DP max 7 m |
|  3/4" |  10m | 4.800 kg |  COLOR BOX |

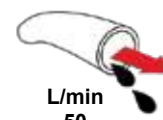

L/min
50



Hmax
10 m



DPmax
7 m

| Art.No | gross weight | in cartoon | barcode |
|--------|--------------|------------|---------------|
| 070144 | 5.130 kg | 4 pcs | 3800123174605 |

SUBMERSIBLE PUMP FOR SEWAGE WATER RD-WP002EX

[BG] Помпа водна потопяема за мръсна вода • [RO] Pompa submersibila pentru apa murdara • [SR] Pumpa potarajuća • [MK] Потопна пумпа • [RU] Насос Погружной • [SL] Potopna črpalčka za vodo • [EL] Υποβρύχια αντλία νερού • [HR] Potopna pumpa za prijavu vodu • [FR] Pompe submersible pour eaux usées • [IT] Pompa sommergibile per acque reflue • [ES] Sumergible pumpilo por kloakaja akvo • [PT] Bomba submersível

| | | | |
|--|---------------|---|--|
| 230V~ 50Hz | 400 W | 2900 min ⁻¹ | |
| H max 5 m | DP max 5 m | 133 l/min | |
|  1" | 6.2 kg |  COLOR BOX | |



FOLDABLE LEGS



L/min
133



Hmax
5 m



DPmax
5 m

| Art.No | gross weight | in cartoon | barcode |
|--------|--------------|------------|---------------|
| 070106 | 6.680 kg | 4 pcs | 3800123124037 |

SUBMERSIBLE PUMP FOR SEWAGE WATER

[BG] Помпа водна потопяема за мръсна вода • [RO] Pompa submersibila pentru apa murdara • [SR] Pumpa rotarajuća • [MK] Потопна пумпа • [RU] Насос Погружной • [SL] Potopna črpalka za vodo • [EL] Υποβρύχια αντίλα νερού • [HR] Potopna pumpa za prljavu vodu • [FR] Pompe submersible pour eaux usées • [IT] Pompa sommergibile per acque reflue • [ES] Sumergebla pumpilo por kloakaja akvo • [PT] Bomba submersível

RDP-WP42

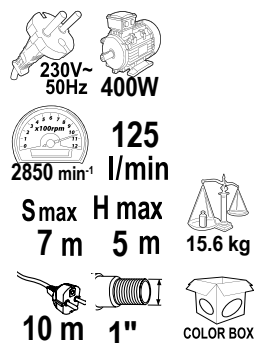

NEW PRODUCT



| Art.No | gross weight | in cartoon | barcode |
|--------|--------------|------------|---------------|
| 070150 | 15.950 kg | 4 pcs | 3800972015746 |

RD-WP40

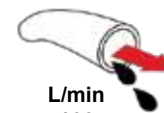
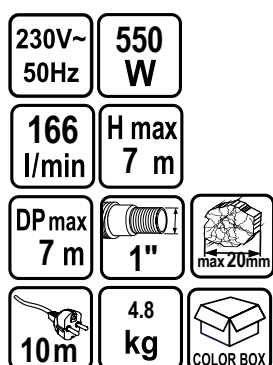

| Art.No | gross weight | in cartoon | barcode |
|--------|--------------|------------|---------------|
| 070147 | 5.000 kg | 4 pcs | 3800123174636 |

RD-WP12

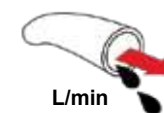
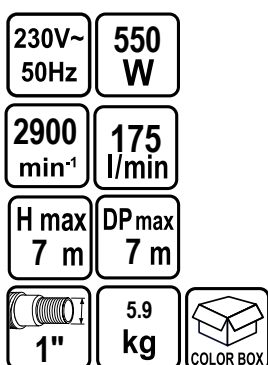



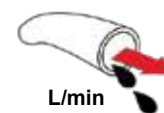
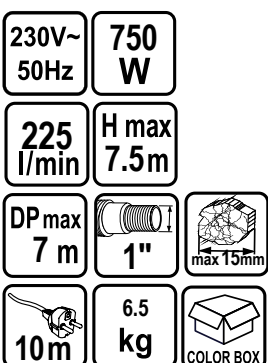

| Art.No | gross weight | in cartoon | barcode |
|--------|--------------|------------|---------------|
| 070110 | 6.380 kg | 4 pcs | 3800123127885 |

RD-WP38



| Art.No | gross weight | in cartoon | barcode |
|--------|--------------|------------|---------------|
| 070145 | 6.750 kg | 4 pcs | 3800123174612 |





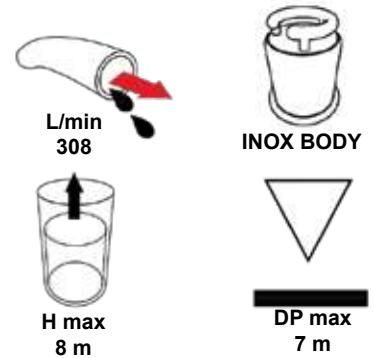



RD-WP39

| | |
|---|--|
| 230V~ 50Hz | 1100 W |
| 308 l/min | H max 8 m |
| DP max 7 m |  1"  max 20mm |
|  10m | 7.400 kg  COLOR BOX |



| Art.No | gross weight | in carton | barcode |
|--------|--------------|-----------|---------------|
| 070146 | 7.750 kg | 4 pcs | 3800123174629 |





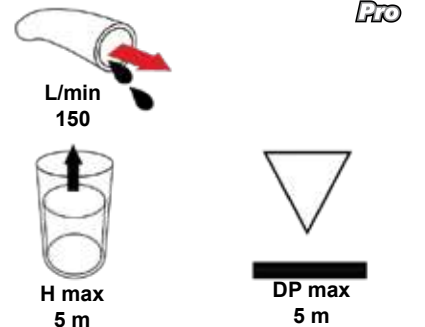



RDP-WP28

| | | |
|--|---|--|
|  230V~ 50Hz |  400W | <ul style="list-style-type: none"> ▶ Sensor automatic adjustment of the pumping level ▶ Manual control |
|  2900 min ⁻¹ | 150 l/min | |
| H max 5 m | DP max 5 m | |
|  3/4"-1.1/2" |  max 35mm | |
|  10 m |  4.8 kg  COLOR BOX | |



| Art.No | gross weight | in carton | barcode |
|--------|--------------|-----------|---------------|
| 070135 | 5.250 kg | 4 pcs | 3800123166198 |





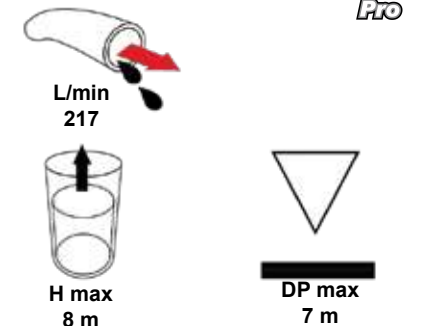



RDP-WP25

| | |
|--|---|
|  230V~ 50Hz |  750W |
|  2900 min ⁻¹ | 217 l/min |
| H max 8 m | DP max 7 m |
|  3/4"-1.1/2" |  max 30mm |
|  10 m |  6.5 kg  COLOR BOX |



| Art.No | gross weight | in carton | barcode |
|--------|--------------|-----------|---------------|
| 070132 | 6.750 kg | 4 pcs | 3800123166167 |

RDP-WP26

| | |
|--|---|
|  230V~ 50Hz |  900W |
|  2900 min ⁻¹ | 250 l/min |
| H max 9.5 m | DP max 7 m |
|  3/4"-1.1/2" |  max 5mm |
|  10 m |  7 kg  COLOR BOX |

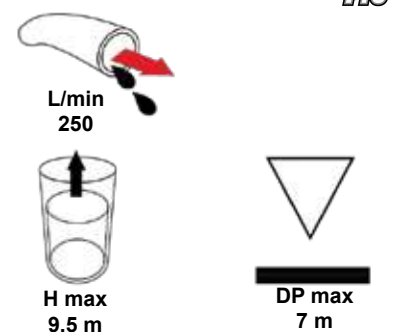

| Art.No | gross weight | in carton | barcode |
|--------|--------------|-----------|---------------|
| 070133 | 7.300 kg | 4 pcs | 3800123166174 |

RDP-WP27

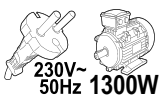

230V~
50Hz 1300W
417
l/min

2900 min⁻¹
H max 11 m DP max 7 m

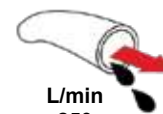
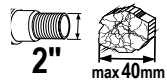

L/min
250



H max
9.5 m



DP max
7 m

| Art.No | gross weight | in cartoon | barcode |
|--------|--------------|------------|---------------|
| 070134 | 8.630 kg | 4 pcs | 3800123166181 |

SUBMERSIBLE PUMP FOR CLEAN WATER

[BG] Помпа водна дълбочинна за чиста вода • [RO] Pompa submersibila pentru apa curate • [SR] Pompa potoparajuća • [MK] Потопна пумпа [RU] Насос погружной • [SL] Potopna črpalčka za vodo • [EL] Υποβρύχια αντλία νερού • [HR] Potopna pumpa za čistu vodu • [FR] Pompe submersible pour l'eau propre • [IT] Pompa sommergibile per acqua pulita • [ES] Sumergebla pumpilo por pura akvo • [PT] Bomba submersivel

RD-WP41

230V~
50Hz 750
W

40
l/min H max
60 m



9.00
kg COLOR BOX

CONTROL BOARD



INOX BODY

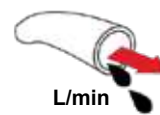

L/min
40



H max
60 m

| Art.No | gross weight | in cartoon | barcode |
|--------|--------------|------------|---------------|
| 070148 | 12.880 kg | | 3800123174711 |

RD-WP31

230V~
50Hz 700
W

2900
min⁻¹ 65
l/min H max
45 m



22m 11.00
kg COLOR BOX

**STAINLESS STEEL BODY
CONTROL BOARD**



INOX BODY







L/min
65



H max
45 m

| Art.No | gross weight | in cartoon | barcode |
|--------|--------------|------------|---------------|
| 070138 | 14.010 kg | | 3800123166716 |

RD-WP24

| | | |
|--|--|---|
| 230V~ 50Hz | 1100 W | |
| 2900 min ⁻¹ | 80 l/min | H max 91 m |
|  Impeller X14 |  1.1/4" |  20 m |
|  22 m | 18.00 kg |  COLOR BOX |

STAINLESS STEEL BODY
CONTROL BOARD



INOX BODY



L/min
80





H max
91 m

| Art.No | gross weight | in cartoon | barcode |
|--------|--------------|------------|---------------|
| 070131 | 20.410 kg | | 3800123164590 |

ELECTRONIC BOOSTER PUMP RD-WP17

• [BG] Помпа с електронен пресостат • [RO] Pompa de apa • [SR] Pumpa • [MK] Водна пумпа • [RU] Насос • [SL] črpalka za vodo • [EL] αντλία νερού • [HR] Pumpa sa elektroničke regulator tlaka • [FR] Pompe de surpression électronique • [IT] Pompa booster elettronica • [ES] Elektronika pumpilo • [PT] Bomba elétrica

| | | |
|--|--------------|---|
| 230V~ 50Hz | 1200 W | |
| 3 bar | 64 l/min | |
| H max 48 m | S max 7 m | |
|  1" | 8.300 kg |  COLOR BOX |



L/min
64



H max
9.5 m



INOX BODY



S max
7 m







| Art.No | gross weight | in cartoon | barcode |
|--------|--------------|------------|---------------|
| 070119 | 9.500 kg | | 3800123158353 |

SELF PRIMING PUMP WITH WATER FILTER AND LCD DISPLAY RDP-WP45

• [BG] Помпа водна с воден филтър и LCD дисплей • [RO] Pompa cu autoamorsare • [SR] Pumpa sa filtrom za vodu i LCD displejem • [MK] Водна пумпа со филтер за вода и LCD дисплеј • [RU] Насос с водяным фильтром и LCD-дисплеем • [SL] Črpalka za vodo z vodnim filtrom in LCD zaslonom • [EL] Αντλία νερού • [HR] Pumpa za vodu • [FR] Pompe centrifuge • [IT] Pompa centrifuga • [ES] Centrifugaj pumproj • [PT] Bomba

WITH ELECTRONIC
BOOSTER



| | | |
|---|---|--|
|  230V~ 50Hz |  1100W |  2850 min ⁻¹ |
| 77 l/min | H max 45 m | S max 7 m |
|  1" |  1 m |  10.250 kg |
| | |  COLOR BOX |

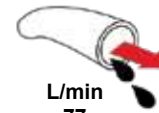

L/min
77



H max
45 m

RAIDER®
Pro



S max
7 m

| Art.No | gross weight | in cartoon | barcode |
|--------|--------------|------------|---------------|
| 070153 | 11.130 kg | | 3800972015791 |



FOUNTAIN PUMP

• [BG] Помпа водна фонтан • [RO] Pompa fantana arteziana • [SR] Pumpa za fontanu • [MK] Пумпа за фонтану • [RU] Фонтанный насос • [SL] Črpalka za vodnjake • [EL] Αντλία σιντριβανιού
• [HR] Pumpa za fontane • [FR] Pompe de fontaine • [IT] Pompa per fontana • [ES] Fonta pumpilo • [PT] Bomba de água

RD-WP35

| | |
|---------------|---------------|
| 230V~ 50Hz | 28 W |
| 20 l/min | H max 1.6m |
| Smax 3 m | 1/2" |
| 10m | 1.600 kg |
| | COLOR BOX |

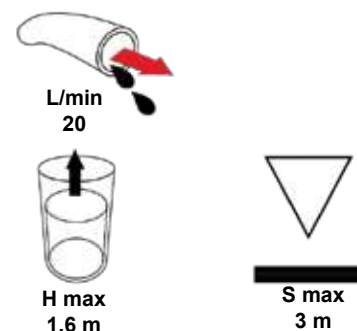

| Art.No | gross weight | in cartoon | barcode |
|--------|--------------|------------|---------------|
| 070142 | 1.720 kg | 12 pcs | 3800123174582 |

RD-WP21

| | |
|---------------|--------------|
| 230V~ 50Hz | 50 W |
| 33 l/min | H max 3 m |
| Smax 2.5m | 1" |
| 10m | 1.700 kg |
| | COLOR BOX |

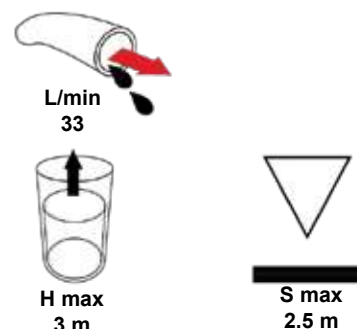

| Art.No | gross weight | in cartoon | barcode |
|--------|--------------|------------|---------------|
| 070124 | 2.010 kg | 8 pcs | 3800123161452 |

RD-WP36

| | |
|---------------|---------------|
| 230V~ 50Hz | 75 W |
| 43 l/min | H max 2.6m |
| Smax 3 m | 1" |
| 10m | 3.100 kg |
| | COLOR BOX |

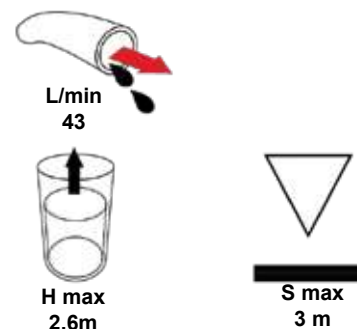

| Art.No | gross weight | in cartoon | barcode |
|--------|--------------|------------|---------------|
| 070143 | 3.430 kg | 6 pcs | 3800123174599 |

AUTOMATIC PUMP CONTROLLER RD-EPC02

• [BG] Пресостат електронен • [RO] Dispozitiv de comanda electronic • [SR] Kontroler pumpe • [MK] Автоматски контролер на пумпа • [RU] Реле давления воды • [SL] Elektronsko tlačno stikalo
• [EL] Ηλεκτρονικός Ελεγκτής Πίεσης Αντλιών • [HR] Tlačna sklopka, elektronička • [FR] Contrôleur de pompe automatique • [IT] Regolatore automatico della pompa • [ES] Automata bomba regilo
• [PT] Controlador de bomba automático

| |
|------------------|
| 230V~ 50Hz |
| 2200 W |
| Pmax 1 MPa |
| 0.900 kg |
| COLOR BOX |



MANOMETER



| Art.No | gross weight | in cartoon | barcode |
|--------|--------------|------------|---------------|
| 070127 | 1.120 kg | 12 pcs | 3800123161483 |

BOOSTER PUMP WITH PRESSURE TANK

• [BG] Хидрофор • [RO] Hidrofor • [SR] Hidropak • [MK] Хидрофор • [RU] Гидрофор • [SL] Ohišje črpalke in tlačna posoda • [EL] Μονάδα αντλίας πίεσης • [HR] Hidropak za vodu • [FR] Pompe de surpression avec réservoir sous pression • [IT] Pompa di aumento pressione con serbatoio a pressione • [ES] Akcelilo kun premotanko • [PT] Bomba de reforço e tanque

RD-WP800S

**NEW
PRODUCT**



| | | |
|--|---------------|---|
| 230V~ 50Hz | 800 W | 53 l/min |
| 3 bar | H max 40 m | Smax 7 m |
|  1" | 10.790 kg |  COLOR BOX |



| Art.No | gross weight | in cartoon | barcode |
|--------|--------------|------------|---------------|
| 071106 | 11.350 kg | | 3800972015784 |

RDP-WP800SW

**NEW
PRODUCT**



| | | |
|--|---------------|---|
| 230V~ 50Hz | 800 W | 53 l/min |
| 3 bar | H max 40 m | Smax 7 m |
|  1" | 12.100 kg |  COLOR BOX |



| Art.No | gross weight | barcode |
|--------|--------------|---------------|
| 071105 | 12.600 kg | 3800972015777 |

RD-WP1200S

**NEW
PRODUCT**

| | | |
|--|---------------|---|
| 230V~ 50Hz | 1200 W | 64 l/min |
| 3 bar | H max 48 m | Smax 7 m |
|  1" | 11.790 kg |  COLOR BOX |



| Art.No | gross weight | barcode |
|--------|--------------|---------------|
| 071107 | 12.350 kg | 3800972017986 |

RD-WP1300S

**NEW
PRODUCT**

| | | |
|--|---------------|---|
| 230V~ 50Hz | 1300 W | 80 l/min |
| 3 bar | H max 48 m | Smax 8 m |
|  1" | 12.590 kg |  COLOR BOX |



| Art.No | gross weight | barcode |
|--------|--------------|---------------|
| 071108 | 13.000 kg | 3800972017993 |

RD-WP1200J

| | | |
|---------------|---------------|--------------|
| 230V~ 50Hz | 1200 W | 64 l/min |
| 3 bar | H max 48 m | S max 7 m |
| 1" | 13.500 kg | COLOR BOX |

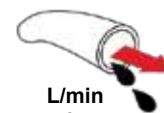
L/min
64

H max
48 m

S max
7 m

| Art.No | gross weight | in cartoon | barcode |
|--------|--------------|------------|---------------|
| 071104 | 14.000 kg | | 3800123158360 |

RD-WP1300

| | | |
|---------------|---------------|--------------|
| 230V~ 50Hz | 1300 W | 75 l/min |
| 3 bar | H max 48 m | S max 8 m |
| 1" | 18.000 kg | COLOR BOX |

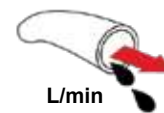
L/min
75

H max
48 m

S max
8 m

| Art.No | gross weight | in cartoon | barcode |
|--------|--------------|------------|---------------|
| 070125 | 18.500 kg | | 3800123161469 |

GASOLINE WATER PUMP

• [BG] Помпа водна бензинова • [RO] Motorpompa cu motor pe benzina • [SR] Pumpa za navodnjavanje motorna • [MK] Пумпа за вода на бензин • [RU] Мотопомпа бензиновая • [SL] Bencinska vodna črpalka • [EL] Βενζινοκίνητη αντλία νερού • [HR] Motorna crpka za vodu • [FR] Pompe à eau essence • [IT] Pompa ad acqua benzina • [ES] Bombo por benzino • [PT] Bomba de água a gasolina

RD-GWP02J

• Двигател: Едноцилиндров, бензинов, двутактов с въздушно охлаждане
• Engine type: Air cooling, single cylinder, two stroke

| | | |
|----------------------|----------------------------|-----------------------|
| 25.4 cm ³ | 8300 W | 133 l/min |
| H max 17.5m | 6 500 min ⁻¹ | FUEL / OIL 25:1 |
| S max 8 m | 1" | 0.7 |
| ml 700 | 8.050 kg | COLOR BOX |

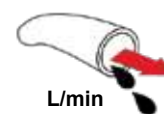
L/min
133







H max
17.5 m

S max
8 m

| Art.No | gross weight | in cartoon | barcode |
|--------|--------------|------------|---------------|
| 079908 | 8.600 kg | | 3800123158407 |

RD-GWP03J

- Двигател: Едноцилиндров, бензинов, двутактов с въздушно охлаждане
- Engine type: Air cooling, single cylinder, two stroke

| | | |
|--|--|---|
|  42.7 cm ³ | 1250 W | 250 l/min |
| H max 35 m | 6 500 min⁻¹ | FUEL / OIL 25:1 |
| S max 8 m |  1.5" |  1/h |
|  ml 1500 |  | 5.550 kg |
| | |  COLOR BOX |



L/min
250



H max
35 m







S max
8 m

| Art.No | gross weight | in carton | barcode |
|--------|--------------|-----------|---------------|
| 092101 | 6.000 kg | | 3800123161315 |

RD-GWP01

- Двигател: Едноцилиндров, бензинов, четиритактов с въздушно охлаждане
- Engine type: Air cooling, single cylinder, four stroke

| | | |
|---|--|---|
|  196 cm ³ | 4100 W | |
| 550 l/min | H max 26 m | 3 600 min⁻¹ |
| S max 8 m |  2" |  ml 600 |
|  ml 3800 |  | 22.100 kg |
| | |  COLOR BOX |



L/min
550



H max
35 m









S max
8 m

| Art.No | gross weight | in carton | barcode |
|--------|--------------|-----------|---------------|
| 079906 | 23.000 kg | | 3800123112980 |

RD-GWP04

NEW PRODUCT

- Двигател: Едноцилиндров, бензинов, четиритактов с въздушно охлаждане
- Engine type: Air cooling, single cylinder, four stroke

| | | |
|---|--|---|
|  196 cm ³ | 4900 W | |
| 933 l/min | H max 30 m | 3 600 min⁻¹ |
| S max 8 m |  3" |  0.6 |
|  ml 3800 |  | 22.700 kg |
| | |  COLOR BOX |



L/min
933



H max
30 m



S max
8 m

| Art.No | gross weight | barcode |
|--------|--------------|---------------|
| 070149 | 24.000 kg | 3800972003569 |

GASOLINE HIGH PRESSURE CLEANER RD-GHPC06

• [BG] Водоструйка бензинова • [RO] Aparat de spalat cu presiune cu motor pe benzina
 • [SR] Benzin visokotlačni čistač • [MK] Бензин машина за перење под висок притисок
 • [RU] Бензиновая мойка высокого давления • [SL] Bencin visokotlačni čistilec • [EL] Πλυντικό υψηλής πίεσης • [HR] Visokotlačni čistač motorni • [FR] Nettoyeur haute pression essence • [IT] Idropulitrice a benzina • [ES] Limpiador de alta presión de gasolina • [PT] Lavadora a gasolina

**NEW
PRODUCT**

**5200
W**
208 cm³
**P_{max}
20
MPa**
**3 600
min⁻¹**
**ml
600**
**max.
10
l/min**
**S_{max}
1 m**
**2.0
l/kWh**
**ml
3600**
**30.00
kg**
COLOR BOX

| Art.No | gross weight | barcode |
|--------|--------------|---------------|
| 072104 | 34.000 kg | 3800972010673 |



HIGH PRESSURE CLEANER

• [BG] Водоструйка • [RO] Aparat de spalat cu presiune • [SR] Perač pod pritiskom • [MK] Машина за перење под висок притисок • [RU] Мойка высокого давления • [SL] Visokotlačni čistilec
 • [EL] Πλυντικό υψηλής πίεσης • [HR] Visokotlačni čistač • [FR] Nettoyeur haute pression • [IT] Pulitore ad alta pressione • [ES] Alta premo • [PT] Lavadora

RD-HPC05

**NEW
PRODUCT**

| | |
|-------------------------------|--|
| 230V~ 50Hz | 1400 W |
| P _{max} 12 MPa | 6 l/min |
| 6.400 kg |  COLOR BOX |

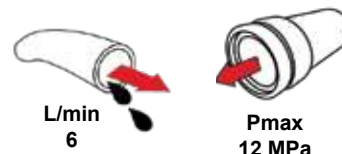

| Art.No | gross weight | in carton | barcode |
|--------|--------------|-----------|---------------|
| 072103 | 7.300 kg | | 3800972009172 |

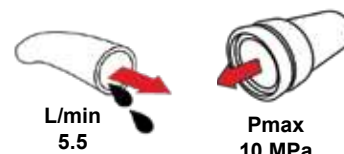

RD-HPC01

| | |
|-------------------------------|--|
| 230V~ 50Hz | 1400 W |
| P _{max} 10 MPa | 5.5 l/min |
| 5.700 kg |  COLOR BOX |



| Art.No | gross weight | in carton | barcode |
|--------|--------------|-----------|---------------|
| 123201 | 6.400 kg | | 3800123115554 |

RD-HPC02

| | |
|---|--|
| 230V~ 50Hz | 1800 W |
| P _{max} 14 MPa | 6.7 l/min |
|  8.900 kg |  COLOR BOX |

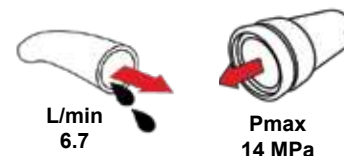

| Art.No | gross weight | in carton | barcode |
|--------|--------------|-----------|---------------|
| 123202 | 10.060 kg | | 3800123140938 |

RD-HPC07
**NEW
PRODUCT**

| | |
|-------------------------------|--|
| 230V~ 50Hz | 2200 W |
| P _{max} 17 MPa | 7.5 l/min |
| 8.200 kg |  COLOR BOX |



| Art.No | gross weight | in cartoon | barcode |
|--------|--------------|------------|---------------|
| 072105 | 9.500 kg | 1pcs | 3800972015982 |

RD-HPC08
**NEW
PRODUCT**

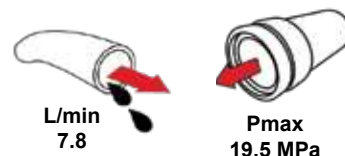

| | |
|---------------------------------|--|
| 230V~ 50Hz | 2500 W |
| P _{max} 19.5 MPa | 7.8 l/min |
| 8.600 kg |  COLOR BOX |



| Art.No | gross weight | in cartoon | barcode |
|--------|--------------|------------|---------------|
| 072106 | 9.800 kg | 1pcs | 3800972015999 |

AUTOMATIC CABLE REEL WATERPROOF

• [BG] Удължител на автоматична макара влагоустойчива • [RO] Prelungitor pe tambur rezistent la umiditate • [SR] Automatski produžetak bubnja • [MK] Автоматско продолжување на ролна
 • [RU] Автоматический удлинитель барабана влагоустойкий • [SL] Samodejni odtegovalnik koluta odporen na vlago • [EL] Αυτόματη επέκταση επένδυση με μπιμπίνα • [HR] Automatski proizužnik bubnja
 • [FR] Extendeur automatique de bobine résistant à l'humidité • [IT] Estensione bobina automatica resistente all'umidità • [ES] Aútomata reel-etenda humideco • [PT] Extensor de bobina automático resistente à umidade

| | |
|---|--|
| 250 V |  20m |
|  3x1.5mm ² |  COLOR BOX |



| Art.No | gross weight | in cartoon | barcode |
|--------|--------------|------------|----------------|
| 070128 | 3.500 kg | | 38001231611490 |



ELECTRIC INDUSTRIAL FAN HEATER

• [BG] Калорифер електрически • [RO] Incalzitor electric • [SR] Električni grejač • [MK] Калорифер електрични [RU] Электрический нагреватель • [SL] Električni grelec zraka • [EL] Ηλεκτρική θερμάστρα
 • [HR] Električni grijač • [FR] Aérotherme industriel électrique • [IT] Termoventilatore elettrico industriale • [ES] Elektra industria ventumilo • [PT] Aquecedor elétrico industrial

RD-EFH02

| | |
|---------------------------------|---------------|
| 230V~ 50Hz | 2000 W |
| 100m³/h | 25/1000/2000W |
| L: 23cm W: 22cm H: 31.5cm | 20m³ |
| 3.600 kg | COLOR BOX |



HEATING AREA
20 m³

| Art.No | gross weight | barcode |
|--------|--------------|---------------|
| 078801 | 4.000 kg | 3800123167874 |

RD-EFH03

| | |
|-----------------------------------|---------------|
| 230V~ 50Hz | 3000 W |
| 150m³/h | 25/1000/2000W |
| L: 25.4cm W: 25cm H: 31.5cm | 30m³ |
| 4.400 kg | COLOR BOX |



HEATING AREA
30 m³

| Art.No | gross weight | barcode |
|--------|--------------|---------------|
| 078806 | 4.900 kg | 3800123167911 |

RD-EFH3.3

| | |
|-----------------------------------|---------------|
| 230V~ 50Hz | 3300 W |
| 150m³/h | 30/1500/3000W |
| L: 27 cm W: 25.5cm H: 40 cm | 30m³ |
| 4.800 kg | COLOR BOX |



HEATING AREA
30 m³

| Art.No | gross weight | barcode |
|--------|--------------|---------------|
| 123303 | 5.500 kg | 3800123133886 |

RD-EFH05

| | |
|---------------------------------|---------------|
| 400V~ 50Hz | 5000 W |
| 200m³/h | 45/2500/5000W |
| L: 27cm W: 25.5cm H: 40cm | 50m³ |
| 4.900 kg | COLOR BOX |

HEATING AREA
50 m³

| Art.No | gross weight | barcode |
|--------|--------------|---------------|
| 078803 | 5.700 kg | 3800123167881 |

RD-EFH09

| | |
|---------------------------------|---------------|
| 400V~ 50Hz | 9000 W |
| 300m³/h | 55/4500/9000W |
| L: 35cm W: 35cm H: 50.5cm | 80m³ |
| 9.500 kg | COLOR BOX |

HEATING AREA
80 m³

| Art.No | gross weight | barcode |
|--------|--------------|---------------|
| 078804 | 10.400 kg | 3800123167898 |

RD-EFH15

| | |
|-------------------------------|----------------|
| 400V~ 50Hz | 15000 W |
| 400m³/h | 65/7500/15000W |
| L: 46cm W: 39cm H: 59cm | 120m³ |
| 16.400 kg | COLOR BOX |

HEATING AREA
120 m³

| Art.No | gross weight | barcode |
|--------|--------------|---------------|
| 078805 | 17.400 kg | 3800123167904 |

GAS HEATER

• [BG] Калорифер на газ • [RO] Aeroterma • [SR] Grejač gasni • [MK] Калорифер на газ • [RU] Подогреватель газа пропана • [SL] Plinov Grelnik • [EL] Θερμάστρα αερίου • [HR] Plinski grijač
• [FR] Chauffage à gaz • [IT] Stufa a gas • [ES] Gas-hejtilo • [PT] Aquecedor a gas

RD-GH15

| | |
|-------------------------------------|-------------|
| 230V~ 50Hz | 15000 W |
| 300m³/h | 116m³ |
| L: 47.3cm W: 20.7cm H: 32.2cm | 4.600 kg |
| | COLOR BOX |

HEATING AREA
116 m³

| Art.No | gross weight | barcode |
|--------|--------------|---------------|
| 129973 | 5.200 kg | 3800123101809 |

RD-GH40

| | |
|-------------------------------------|-------------|
| 230V~ 50Hz | 40000 W |
| 750m³/h | 310m³ |
| L: 57.2cm W: 22.5cm H: 37.4cm | 6.400 kg |
| COLOR BOX | |



HEATING AREA
310 m³

| Art.No | gross weight | in cartoon | barcode |
|--------|--------------|------------|---------------|
| 450201 | 7.100 kg | | 3800123167928 |

DIESEL SPACE HEATER RD-DSH50

• [BG] Калорифер нафтов • [RO] Generator aer cald ardere directa diesel • [SR] Grejač Nafta • [MK] Калорифер нафтов • [RU] Тепловая пушка • [SL] Premični grelnik zraka • [EL] Αεροθερμο Πετρελαίου
• [HR] Dizelski grijač • [FR] Chauffage spatial diesel • [IT] Riscaldatore di spazio diesel • [ES] Dieselera calentador • [PT] Aquecedor a diesel

| | |
|--------------------------------|--------------|
| 230V~ 50Hz | 50 kW |
| 800m³/h | 400m³ |
| L: 110cm W: 48cm H: 50cm | 28.900 kg |
| COLOR BOX | |



HEATING AREA
400 m³

| Art.No | gross weight | in cartoon | barcode |
|--------|--------------|------------|---------------|
| 123304 | 31.500 kg | | 3800123133893 |

HANDLE MIXER

• [BG] Миксер • [RO] Amestecator • [SR] Mešač • [MK] Рачна Мешалка • [RU] Перемешиватель
• [SL] Mešalnik • [EL] Δραπάνο Αναδευτήρας • [HR] Miješalica • [FR] Mélangeur à poignée
• [IT] Maneggiare il mixer • [ES] Manlibro miksažo • [PT] Misturadora manual

RD-HM07

| | | |
|---------------|-------------|----------------------------|
| 230V~ 50Hz | 1200 W | 0-600 min ⁻¹ |
| M14x2mm | Ø120/590 mm | max 40L |
| | 3.900 kg | COLOR BOX |



VARIABLE SPEED



M14x2 mm

ERGONOMICAL
HANDLE

| Art.No | gross weight | in cartoon | barcode |
|--------|--------------|------------|---------------|
| 078508 | 4.400 kg | 4 pcs | 3800972009219 |

RD-HM011

| | | |
|------------------------|-------------|----------------------------|
| NEW PRODUCT | | |
| 230V~ 50Hz | 1600 W | 0-750 min ⁻¹ |
| M14x2mm | Ø120/590 mm | max 50L |
| | 4.350 kg | COLOR BOX |



VARIABLE SPEED







M14x2 mm

ERGONOMICAL
HANDLE

| Art.No | gross weight | in cartoon | barcode |
|--------|--------------|------------|---------------|
| 078511 | 4.500 kg | 2 pcs | 3800972019720 |

RD-HM05

| | |
|---|---|
| 230V~ 50Hz | 1280 W |
| 0-550 min ⁻¹ |  |
|  |  |
|  | 3.900 kg |
|  | |



VARIABLE SPEED





HIGH TORQUE



TWO FUNCTION

| Art.No | gross weight | in cartoon | barcode |
|--------|--------------|------------|---------------|
| 078503 | 4.540 kg | 4 pcs | 3800123133732 |

RD-HM02







| | |
|--|---|
| 230V~ 50Hz | 850 W |
| 0-500 min ⁻¹ |  |
|  | 3.900 kg |
|  | |



VARIABLE SPEED

| Art.No | gross weight | in cartoon | barcode |
|--------|--------------|------------|---------------|
| 129999 | 5.000 kg | 4 pcs | 3800123133732 |

RD-HM08

| | | |
|---|---|---|
| 230V~ 50Hz | 1400 W | 200-700 min ⁻¹ |
|  |  |  |
|  |  | 5.030 kg |
|  | | |



M14x2 mm



VARIABLE SPEED







LED



ERGONOMICAL HANDLE

| Art.No | gross weight | in cartoon | barcode |
|--------|--------------|------------|---------------|
| 078509 | 6.000 kg | 4 pcs | 3800972009158 |

RDP-HM03

| | | |
|---|------------------------------|---|
|  | 1400W | 2x GEARS |
|  | 1' 180-460 min ⁻¹ | 2' 300-700 min ⁻¹ |
|  | 5.679 kg |  |



RAIDER®
Pro



VARIABLE SPEED

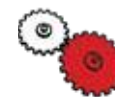

TWO GEARS

| Art.No | gross weight | in cartoon | barcode |
|--------|--------------|------------|---------------|
| 078501 | 6.310 kg | 2 pcs | 3800123166860 |



RDP-HM10

**NEW
PRODUCT**

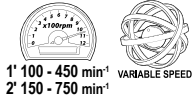
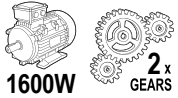

**RAIDER®
Pro**



VARIABLE SPEED

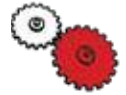

TWO GEARS

| Art.No | gross weight | barcode |
|--------|--------------|--------------|
| 078602 | 6.900 kg | 380097208020 |

HANDLE MIXER WITH TWO PADDLES RDP-HM09

• [BG] Миксер с две бъркалки • [RO] Amestecator cu două palete • [SR] Mešač sa dve lopatice • [MK] Рачна Мешалка со две лостови • [RU] Перемешиватель с двумя лопастями • [SL] Mešalnik z dvema ročicama • [EL] Δραπάνο Αναδευτήρας • [HR] Miješalica s dvije lopatice • [FR] Mélangeur à deux palettes • [IT] Maneggiare il mixer con due paddle • [ES] Uzu miksažon kun du pakajoj • [PT] Misturadora manual com duas pás

**NEW
PRODUCT**

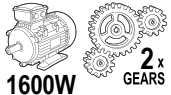

**RAIDER®
Pro**



VARIABLE SPEED



TWO PADDLES

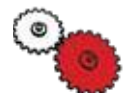

TWO GEARS

| Art.No | gross weight | in carton | barcode |
|--------|--------------|-----------|---------------|
| 078601 | 8.900 kg | 2 pcs | 3800972010758 |

TILE CUTTING MACHINE

• [BG] Машина за плочки • [RO] Dispozitiv pt taiat placi • [SR] Mašina za sečenje pločica • [MK] Машина за сечење на плочки [RU] Машина для резки плитки • [SL] Rezalnik za keramične ploščice
 • [EL] Κόφτης πλακιδίων χειρός • [HR] Rezač ručni za keramičke pločice • [FR] Machine à couper les carreaux • [IT] Tagliapiastrelle • [ES] Kahela mašino • [PT] Máquina de corte de cerâmica

RD-TC02



1.490
kg



| Art.No | gross weight | in cartoon | barcode |
|--------|--------------|------------|---------------|
| 321501 | 1.700 kg | 6 pcs | 3800123116308 |

RD-TC03



3.610
kg



| Art.No | gross weight | in cartoon | barcode |
|--------|--------------|------------|---------------|
| 321511 | 3.980 kg | 6 pcs | 3800123116483 |



| Art.No | Size | Weight | gross weight | in cartoon | barcode |
|----------------|------|--------|--------------|------------|---------------|
| 321502 RD-TC10 | 400 | 4.800 | 4.820 kg | 4 pcs | 3800123116322 |
| 321507 RD-TC12 | 500 | 5.240 | 5.270 kg | 4 pcs | 3800123116315 |
| 321503 RD-TC13 | 600 | 5.700 | 5.880 kg | 4 pcs | 3800123116339 |

RD-TC11



7.700
kg



| Art.No | gross weight | in cartoon | barcode |
|--------|--------------|------------|---------------|
| 321510 | 7.750 kg | 4 pcs | 3800123116292 |

RD-TC14



| Art.No | gross weight | in cartoon | barcode |
|--------|--------------|------------|---------------|
| 321514 | 7.350 kg | 2 pcs | 3800123150425 |

RD-TC16



| Art.No | gross weight | in cartoon | barcode |
|--------|--------------|------------|---------------|
| 321509 | 8.500 kg | | 3800123116452 |

RD-TC31



| Art.No | gross weight | in cartoon | barcode |
|--------|--------------|------------|---------------|
| 321522 | 9.000 kg | 2 pcs | 3800972008953 |

RD-TC18



| Art.No | gross weight | in cartoon | barcode |
|--------|--------------|------------|---------------|
| 321515 | 10.230 kg | 2 pcs | 3800123150418 |

RD-ETC25

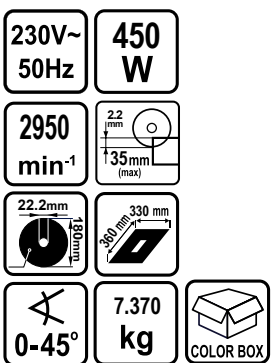

| Art.No | gross weight | in cartoon | barcode |
|--------|--------------|------------|---------------|
| 129991 | 10.500 kg | | 3800123131486 |

RD-ETC20

| | |
|---------------------------|---------------|
| 230V~ 50Hz | 600 W |
| 2800 min ⁻¹ | 35mm (max) |
| 22.2mm | 395mm |
| 180mm | 380mm |
| 0-45° | 10.400 kg |
| | COLOR BOX |



**ADJUSTABLE
CUTTING DEPTH
AND CUTTING ANGLE 45°**

| Art.No | gross weight | barcode |
|--------|--------------|---------------|
| 129908 | 11.500 kg | 3800123124495 |

RD-ETC23

**Motor: Асинхронен електрически двигател със защита от претоварване.
Motor: Asynchronous electric motor with overload protection.**



Foldable legs for quick assembling and easy transportation

| | |
|---------------------------|----------------|
| 230V~ 50Hz | 800 W |
| 2950 min ⁻¹ | m 0.79 |
| 385mm | 35mm (max) |
| 380mm | 480mm (max) |
| 25.4mm | 480mm (max) |
| 200mm | 25.00 kg |
| 0-45° | |



BEVEL CUT 0-45°



PROTRACTOR FOR CROSS CUTTING ANGLE



**ADJUSTABLE
CUTTING DEPTH
AND CUTTING ANGLE 45°**

| Art.No | gross weight | in carton | barcode |
|--------|--------------|-----------|---------------|
| 129937 | 27.000 kg | 1 pcs | 3800123123061 |

RDP-ETC27

| | |
|------------------------|----------------|
| 230V~ 50Hz | 800W |
| 22.2mm | 45° |
| 22mm | 440 |
| 440 | 620mm (max) |
| 5600 min ⁻¹ | 32.40 kg |
| 60mm (max) | |
| 40 | |



**RAIDER®
Pro**



DEPTH CONTROL

| Art.No | gross weight | barcode |
|--------|--------------|---------------|
| 078002 | 36.000 kg | 3800123159060 |

RDP-ETC30

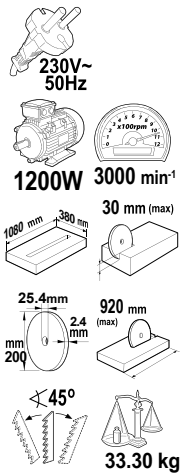

RAIDER[®]
Pro



DEPTH CONTROL

| Art.No | gross weight | barcode |
|--------|--------------|---------------|
| 078005 | 37.000 kg | 3800123172199 |

RDP-ETC26T

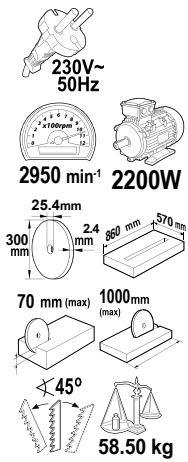

RAIDER[®]
Pro



DEPTH CONTROL

| Art.No | gross weight | barcode |
|--------|--------------|---------------|
| 078001 | 65.000 kg | 3800123159053 |

RDP-ETC29

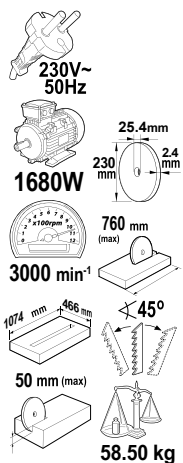

RAIDER[®]
Pro



DEPTH CONTROL

| Art.No | gross weight | barcode |
|--------|--------------|---------------|
| 078004 | 59.000 kg | 3800123168468 |



METAL MINI AIR COMPRESSOR

• [BG] Компресор метален с аксесоари • [RO] Mini Compresor • [SR] Kompresor zaduvanje guma • [MK] Компресорче • [RU] Компрессор для накачивания шин • [SL] Avtomobilski kompresor • [EL] Αεροσυμπιεστής • [HR] Kompresor • [FR] Compresseur de gonflage • [IT] Compressore per gonfiaggio pneumatici • [ES] Kompresoro pri švelaja inflacio • [PT] Compressor de inflação de pneus

RD-AC05

| | |
|-------------|-----------------|
| 12 V | 120 W |
| 35 L/min | P 0.96 Pa |
| 3m | 1 m |
| 1.670 kg | COLOR BOX |



| Art.No | gross weight | in cartoon | barcode |
|--------|--------------|------------|---------------|
| 089402 | 1.700 kg | 10 pcs | 3800123174537 |

RD-AC13

| | |
|----------|-----------------|
| 12 V | 180 W |
| 35 L/min | P 0.96 Pa |
| 1 m | 1.600 kg |
| | COLOR BOX |



**NEW
PRODUCT**

| Art.No | gross weight | in cartoon | barcode |
|--------|--------------|------------|---------------|
| 089408 | 1.700 kg | 10 pcs | 3800972016397 |

RD-AC14

| | | |
|-----------------|-------------|-----------|
| 12 V | 300 W | 70L/min |
| P 0.96 Pa | 3m | |
| 1 m | 1.900 kg | COLOR BOX |



**NEW
PRODUCT**

| Art.No | gross weight | in cartoon | barcode |
|--------|--------------|------------|---------------|
| 089409 | 3.670 kg | 6 pcs | 3800972016408 |

AIR COMPRESSOR

• [BG] Компресор • [RO] Compresor • [SR] Kompresor • [MK] Компресор
 • [RU] Компрессор • [SL] Kompresor [EL] Συμπιεστής • [HR] Kompresor
 • [FR] Compresseur • [IT] Compresore • [ES] Kompresoro [PT] Compressor

RD-AC040

| | |
|---------------------------|-----------------|
| 230V~ 50Hz | 1500 W |
| 2800 min ⁻¹ | P 0.8 MPa |
| IN 195L/min | OUT 110L/min |
| TANK 24 L | 18.00 kg |
| COLOR BOX | |

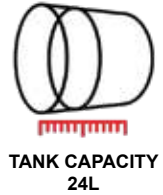

| Art.No | gross weight | barcode |
|--------|--------------|---------------|
| 089401 | 19.000 kg | 3800123173462 |

RD-AC12

NEW PRODUCT

| | | |
|---------------------------|-----------------|-----------|
| 230V~ 50Hz | 1500 W | |
| 2800 min ⁻¹ | P 0.8 MPa | |
| IN 195L/min | OUT 110L/min | 5 m |
| TANK 24 L | 18.00 kg | COLOR BOX |

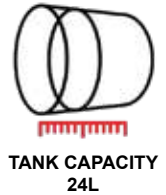

| Art.No | gross weight | barcode |
|--------|--------------|---------------|
| 089407 | 19.000 kg | 3800972016071 |

QUIET OIL FREE AIR COMPRESSOR RD-AC07

• [BG] Компресор тих безмаслен • [RO] Compresor • [SR] Kompresor • [MK] Компресор • [RU] Компрессор • [SL] Kompresor [EL] Συμπιεστής • [HR] Kompresor • [FR] Compresseur • [IT] Compresore
 • [ES] Kompresoro • [PT] Compressor

| | | |
|---------------------------|-----------------|-----------|
| 230V~ 50Hz | 750 W | |
| 1440 min ⁻¹ | P 0.8 MPa | |
| IN 195L/min | OUT 135L/min | |
| TANK 24 L | 20.00 kg | COLOR BOX |

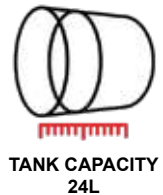

| Art.No | gross weight | barcode |
|--------|--------------|---------------|
| 089405 | 21.000 kg | 3800972009639 |

ACCESSORIES PNEUMATICS RAIDER MACHINES R20 SYSTEM

AIR COMPRESSOR

• [BG] Компресор • [RO] Compresor • [SR] Kompresor • [MK] Компресор • [RU] Компрессор • [SL] Kompresor [EL] Συμπιεστής • [HR] Kompresor • [FR] Compresseur
 • [IT] Compressore • [ES] Kompresoro • [PT] Compressor

RD-AC02

| | |
|---|-----------------|
| 230V~ 50Hz | 1500 W |
| 2800 min ⁻¹ | P 0.8 MPa |
| 195L/min IN | 110L/min OUT |
| TANK 50L | 24.500 kg |
|  COLOR BOX | |

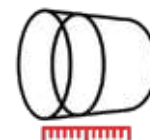

TANK CAPACITY
50L

| Art.No | gross weight | barcode |
|--------|--------------|---------------|
| 120105 | 25.000 kg | 3800123123368 |

RD-AC08

| | |
|---|-----------------|
| 230V~ 50Hz | 2200 W |
| 2800 min ⁻¹ | P 0.8 MPa |
| 195L/min IN | 110L/min OUT |
| TANK 50L | 30.00 kg |
|  COLOR BOX | |

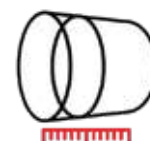

TANK CAPACITY
50L

| Art.No | gross weight | barcode |
|--------|--------------|---------------|
| 089406 | 32.000 kg | 3800972009646 |

RD-AC030

| | |
|---|-----------------|
| 230V~ 50Hz | 2200 W |
| 2800 min ⁻¹ | P 0.8 MPa |
| 370L/min IN | 310L/min OUT |
| TANK 100L | 43.00 kg |
|  COLOR BOX | |

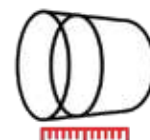

TANK CAPACITY
100L

| Art.No | gross weight | barcode |
|--------|--------------|---------------|
| 120107 | 45.920 kg | 3800123160820 |

RD-AC06

| | |
|---------------------------|---|
| 370V 50Hz | 7500 W |
| 2850 min ⁻¹ | P 0.10 MPa |
| 900L/min OUT | TANK 270L |
| 220 kg |  COLOR BOX |

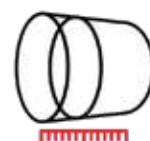

TANK CAPACITY
270L

| Art.No | gross weight | barcode |
|--------|--------------|---------------|
| 089404 | 220 kg | 3800123174735 |

RAIDER[®]

Pneumatic



RAIDER[®]



AIR DRILL RD-AD02

• [BG] Бормашина пневматична • [RO] Masina de gaurit pneumatica • [SR] Bušilica pneumatska • [MK] Бормашина пневматска • [RU] Пневматическая Дрель • [SL] Pnevmatiskih vrtalnik • [EL] Δρέπανο Αέρος • [HR] Pnevmatiska Bušilica • [FR] Perceuse à air • [IT] Trapano pneumatico • [ES] Aera Drilo • [PT] Aparafusadora pneumáticas

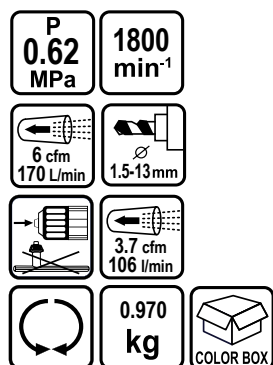

WORKING PRESSURE
0.62 MPa

| Art.No | gross weight | in cartoon | barcode |
|--------|--------------|------------|---------------|
| 080103 | 1.370 kg | 10 pcs | 3800123123689 |

AIR ANGLE GRINDER RD-AAG03

• [BG] Ъглошлайф пневматичен • [RO] Polizor unghiular pneumatic • [SR] Brusilica ugaona pneumatska • [MK] Брусилка пневматска • [RU] Пневматический шлифовальный станок • [SL] Pnevmatiski brusilnik • [EL] Γωνιακός αετρορχός • [HR] Kutna brusilica • [FR] Meuleuse d'angle d'air • [IT] Air Angle Grinder • [ES] Aera Angulo Muelilo • [PT] Rebarbadora pneumáticas

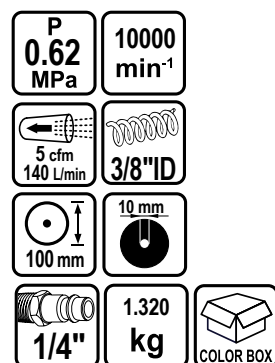

WORKING PRESSURE
0.62 MPa

| Art.No | gross weight | in cartoon | barcode |
|--------|--------------|------------|---------------|
| 089939 | 1.340 kg | 10 pcs | 3800123153648 |

AIR CUT OFF TOOL RD-AC11

• [BG] Резачка пневматична • [RO] Masina de taiat pneumatica • [SR] Brusilica ugaona pneumatska • [MK] Мини брусилка пневматска • [RU] Пневматическая Угловая Шлифовальная машина • [SL] Pnevmatiski Kotni Brusilnik • [EL] Γωνιακός Τροχός Αέρος • [HR] Pnevmatiska rezačica • [FR] Outil de coupeure d'air • [IT] Strumento di taglio pneumatico • [ES] Aero trancita ekstere • [PT] Cortadora pneumática/c/ disco

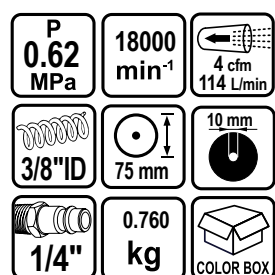

WORKING PRESSURE
0.62 MPa

| Art.No | gross weight | in cartoon | barcode |
|--------|--------------|------------|---------------|
| 089921 | 1.060 kg | 20 pcs | 3800123122415 |

AIR RANDOM ORBIT SANDER RD-AROS01

• [BG] Ексцентършлайф пневматичен • [RO] Slefuitor orbital pneumatic • [SR] Brusilica Rotaciona pneumatska • [MK] Пневматска Ексцентрична Брусилка • [RU] Пневматический Эксцентриковые шлифовальные машины • [SL] Pnevmatiskih Ekscentrični Brusilnik • [EL] Αέρος Εκκεντρο Τριβείο • [HR] Brusilica Ekscentarska • [FR] Ponceuse orbitale Air Random • [IT] Levigatrice orbitale • [ES] Orbital Sander • [PT] Lixadora orbital pneumática



WORKING PRESSURE
0.62 MPa

| Art.No | gross weight | in cartoon | barcode |
|--------|--------------|------------|---------------|
| 089301 | 1.560 kg | 10 pcs | 3800123165375 |

AIR HAMMER MINI RD-AH01

• [BG] Секач пневматичен • [RO] Dalta pneumatica • [SR] Čekić bušilica pneumatski • [MK] Ударен Чекан пневматски [RU] Пневматическое зубило • [SL] Pnevmatiko udarno dleto • [EL] Αεροσφύρα • [HR] Pnevmatiski Čekić • [FR] Marteau Mini • [IT] Aero Martelo • [ES] Aera martelo • [PT] Kit mini-martelo pneumático

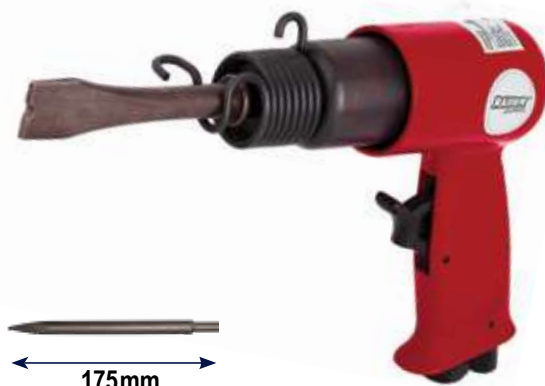
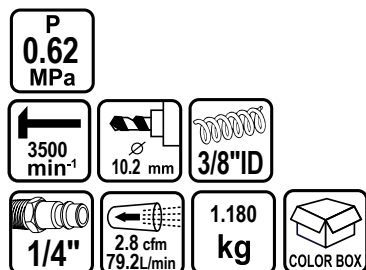

| Art.No | gross weight | in cartoon | barcode |
|--------|--------------|------------|---------------|
| 080102 | 1.760 kg | 10 pcs | 3800123123672 |

AIR MICRO GRINDER RD-AMG01

• [BG] Шлифовалка пневматична микро • [RO] Polizor drept pneumatic • [SR] Brusilica deona pneumatska • [MK] Пневматска Шлајферица [RU] Шлифовальный станок мини • [SL] Zracni Mini Brusilnik • [EL] Μίνι Τροχέιο αέρος • [HR] Jednoručna Brusilica Mini • [FR] Appareil à mouder • [IT] Aero molare • [ES] Muelilo • [PT] Moedor

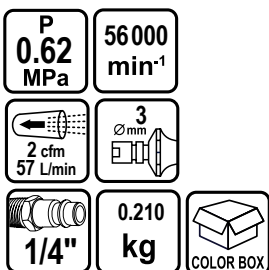

| Art.No | gross weight | in cartoon | barcode |
|--------|--------------|------------|---------------|
| 089920 | 0.330 kg | 20 pcs | 3800123122675 |

AIR DIE GRINDER RD-ADG01

• [BG] Шлифовалка пневматична права • [RO] Polizor drept pneumatic • [SR] Brusilica deona pneumatska • [MK] Пневматска Шлајферица • [RU] Шлифовальный станок мини • [SL] Zracni Mini Brusilnik • [EL] Μίνι Τροχέιο αέρος • [HR] Jednoručna Brusilica • [FR] Broyeur d'air • [IT] Aero Macinino • [ES] Aera Muelilo • [PT] Moedor de ar

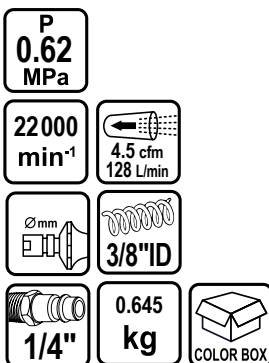

| Art.No | gross weight | in cartoon | barcode |
|--------|--------------|------------|---------------|
| 081102 | 0.680 kg | 20 pcs | 3800123123696 |

AIR ANGLE DIE GRINDER RD-AADG06

• [BG] Шлифовалка пневматична под прав ъгъл • [RO] Polizor drept pneumatic • [SR] Brusilica deona pneumatska [MK] Пневматска Шлајферица • [RU] Шлифовальный станок мини • [SL] Zracni Mini Brusilnik • [EL] Μίνι Τροχέιο αέρος • [HR] Jednoručna Brusilica • [FR] Meuleuse d'angle d'air • [IT] Macinino • [ES] Aera Angulo Muelilo • [PT] Rebarbadora pneumática

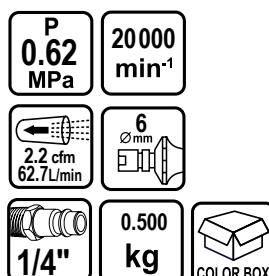

| Art.No | gross weight | in cartoon | barcode |
|--------|--------------|------------|---------------|
| 089924 | 0.690 kg | 20 pcs | 3800123122446 |

AIR RATCHET WRENCH RD-AR01

• [BG] Трещотка пневматична • [RO] Cheie cu clichet pneumatica • [SR] Račna Pnevumatska • [MK] Пневматска крцкалка [RU] Трещотка пневматическая
 • [SL] Zračni ratchet ključem • [EL] Κασάνια αέρος • [HR] Pnevumatska Račna • [FR] Clé à cliquet pneumatique • [IT] Chiave a cricchetto pneumatico • [ES] Slosilo de aera raketo • [PT] Chave de roquete pneumática

| | | |
|-------------------------|---------------------------------|---------------------|
| P 0.62 MPa | 160 min ⁻¹ | 113 L/min |
| 68 Nm | 1/2" inch | 1.210 kg |
| | | COLOR BOX |

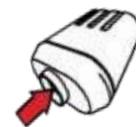

WORKING PRESSURE
0.62 MPa

| Art.No | gross weight | in cartoon | barcode |
|--------|--------------|------------|---------------|
| 089905 | 1.360 kg | 20 pcs | 3800123123702 |

AIR IMPACT WRENCH

• [BG] Гайковерт пневматичен ударен • [RO] Cheie cu impact pneumatica • [SR] Zavrtač set pneumatici • [MK] Пневматски чекан навртвачот • [RU] Пневматический ударный ключ • [SL] Nárazoví ključ [EL] Κρουστικό κλειδί • [HR] Udarni Izvijač • [FR] Clé à chocs pneumatique • [IT] Chiave pneumatica • [ES] Aera Trançilo • [PT] Chave de impacto pneumática

RD-AW03

| | | | |
|-------------------------|----------------------------------|---------------------------|---------------------------|
| P 0.62 MPa | 7000 min ⁻¹ | 4 cfm 114 L/min | 230ft/lb 312N.m |
| 1/2" (13mm) | 3/8"ID | 1/4" | 17 pcs |
| | | 4.100 kg | |



WORKING PRESSURE
0.62 MPa

| Art.No | gross weight | in cartoon | barcode |
|--------|--------------|------------|---------------|
| 089922 | 4.390 kg | 4 pcs | 3800123122422 |

RD-AW04

| | | |
|-------------------------|----------------------------------|-------------------|
| P 0.62 MPa | 4800 min ⁻¹ | 650 N.m |
| 134 L/min | 3/4" | 3/8"ID |
| 1/4" | | 8 pcs |
| 6.300 kg | | |



WORKING PRESSURE
0.62 MPa

| Art.No | gross weight | in cartoon | barcode |
|--------|--------------|------------|---------------|
| 089940 | 6.800 kg | 2 pcs | 3800123153655 |

AIR STAPLER

[BG] Такер пневматичен • [RO] Capsator pneumatic • [SR] Heftalica pneumatica • [MK] Хефталица пнеуматска [RU] Пневматический степлер [SL] Pnevmatiski spenjač • [EL] Συρραπτικό Πεπιεσμένου Αέρα • [HR] Pneumatska Klamerica • [FR] Agrafeuse à air • [IT] Cucitrice ad aria • [ES] Aera Stelo • [PT] Agrafador pneumático

RD-AS01

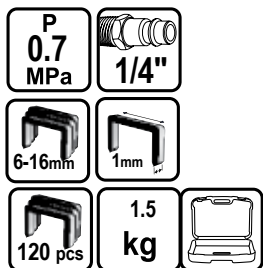

WORKING PRESSURE
0.7 MPa

| Art.No | gross weight | in cartoon | barcode |
|--------|--------------|------------|---------------|
| 089908 | 2.0 kg | 10 | 3800123123146 |

RD-AS03

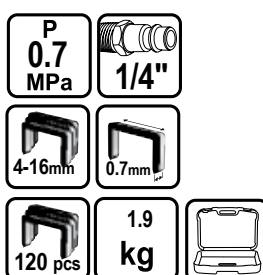

WORKING PRESSURE
0.7 MPa

| Art.No | gross weight | in cartoon | barcode |
|--------|--------------|------------|---------------|
| 088101 | 2.0 kg | 10 | 3800972002326 |

COMBINATED AIR STAPLER AND NAILER

[BG] Такер пневматичен комбиниран • [RO] Capsator pneumatic combi • [SR] Heftalica pneumatica • [MK] Хефталица пнеуматска [RU] Пневматический степлер • [SL] Pnevmatiski spenjač • [EL] Συρραπτικό Πεπιεσμένου Αέρα • [HR] Pneumatska Klamerica • [FR] Agrafeuse à air • [IT] Cucitrice ad aria • [ES] Aera Stelo • [PT] Agrafador pneumático

RD-AS02

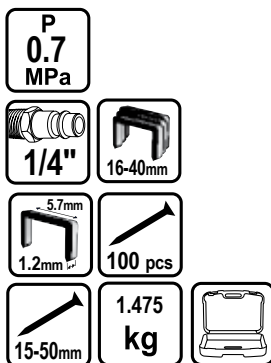

WORKING PRESSURE
0.7 MPa

| Art.No | gross weight | in cartoon | barcode |
|--------|--------------|------------|---------------|
| 089923 | 2.560 | 10 | 3800123122439 |

RD-AS04

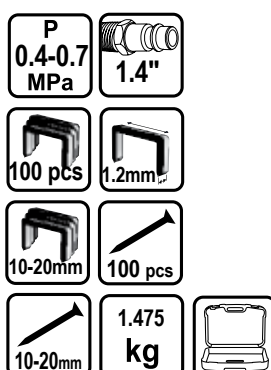

WORKING PRESSURE
0.4 -0.7 MPa

| Art.No | gross weight | in cartoon | barcode |
|--------|--------------|------------|---------------|
| 088102 | 1.520 | 10 | 3800972009141 |

SANDBLASTING GUN SET RD-SBG01

[BG] Пистолет пясъкоструен с аксесоари • [RO] Pistol de sablat • [SR] Pištolj za peskarenje • [MK] Пиштол За Млаз • [RU] Пистолет для струйной обработки • [SL] Pištola Za Peskanje • [EL] Πιστόλι Ακτινοβόλησης • [HR] Pištolj za pjeskarenje • [FR] Set de pistolet de sablage • [IT] Set di pistole per sabbiatura • [ES] Sandblasting Pafilo • [PT] Pistola p/ lixar

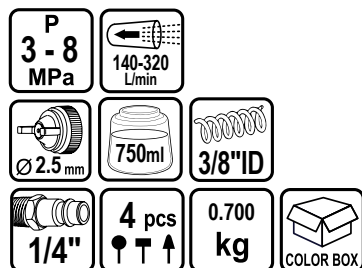

WORKING PRESSURE
3 - 8 MPa

| Art.No | gross weight | in cartoon | barcode |
|--------|--------------|------------|---------------|
| 089942 | 2.080 | 10 | 3800123165382 |

AIR DUSTER GUN

[BG] Пистолет за въздух • [RO] Pistol cu aer • [SR] Pištolj za izduvanje pneumaticki • [MK] Пиштол за воздух • [RU] Пистолет продувочный • [SL] Pnevmatika pištola • [EL] Πιστόλι αέρος • [HR] Pištolj Za Ispuhivanje • [FR] Pistolet à air comprimé • [IT] Spolverino aria pistola • [ES] Armilo de aero • [PT] Pistola ar comprimido

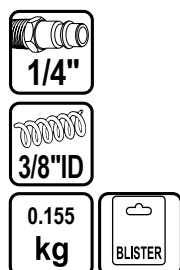

| Art.No | gross weight | in cartoon | barcode |
|--------|--------------|------------|---------------|
| 089802 | 0.170 | 100 | 3800123165382 |

AIR CLEANING GUN RD-C601

[BG] Пистолет за почистване с долно казанче • [RO] Pistol cu tija si rezervor • [SR] Pištolj za izduvanje pneumaticki • [MK] Пиштол за чистење со долно казанче • [RU] Пистолет продувочный • [SL] Pnevmatika pištola • [EL] Πιστόλι αέρος • [HR] Pištolj za Ispuhivanje • [FR] Pistolet de nettoyage d'air • [IT] Pistola per la pulizia dell'aria • [ES] Aera purigado pafilo • [PT] Pistola ar comprimido

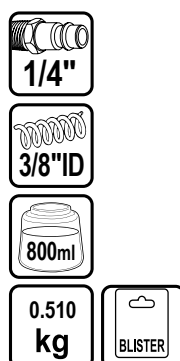

| Art.No | gross weight | in cartoon | barcode |
|--------|--------------|------------|---------------|
| 089916 | 0.660 | 10 | 3800123122408 |

PISTOL-GRIP AIR INFLATOR WITH GAUGE RD-T101

[BG] Пистолет за гуми с манометър • [RO] Manometru • [SR] Pištolj za duvanje guma • [MK] Пиштол за пумпање са манометар • [RU] Пистолет для накачки • [SL] Pištola za polnjenje pnevmatik • [EL] Αεροπίστολο Πλήρωσης Αέρα με Μανόμετρο • [HR] Pištolj sa manometrom • [FR] Gonfleur pistol-grip air avec jauge • [IT] Gonfiatore ad aria compressa con manometro • [ES] Pistol-grip air inflator kun gauge • [PT] Pistola ar comprimido c/ manómetro

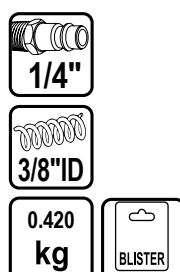

| Art.No | gross weight | in cartoon | barcode |
|--------|--------------|------------|---------------|
| 089904 | 0.420 | 40 | 3800123137075 |

AIR BRUSH 7 PCS KIT RD-AB02

[BG] Аерограф еднодействащ 7 части • [RO] Aerograf • [SR] Set paintbrush pistolj za farbanje • [MK] Комплет за фарбање 7 ком. • [RU] Наносить краску распылителем • [SL] Zračni čopič • [EL] Σετ αερογράφου • [HR] Zračni Kist 7 dijelova • [FR] Kit de brosse à air 7pcs • [IT] Spazzola ad ariaKit 7 pezzi • [ES] Aera Broso 7pcs Kit • [PT] Kit pintura ar comprimido

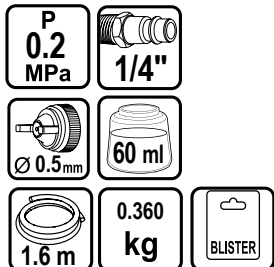

| Art.No | gross weight | in cartoon | barcode |
|--------|--------------|------------|---------------|
| 089936 | 0.520 | 20 | 3800123153389 |

AIR BRUSH PUSH-BUTTON DOUBLE FUNCTION 8 PCS KIT RD-AB01

[BG] Аерограф двойнодействащ 8 части • [RO] Aerograf • [SR] Set paintbrush pistolj za farbanje • [MK] Комплет за фарбање 8 ком • [RU] Наносить краску распылителем • [SL] Zračni čopič • [EL] Σετ αερογράφου • [HR] Zračni Kist 8 dijelova • [FR] Bouton pousseur double fonction Air Brush 8 pcs • [IT] Pulsante a spazzola d'aria a doppia funzione 8 pz • [ES] Air Brush Push-button Duobla Funkcio 8 komputiloj • [PT] Kit pintura ar comprimido

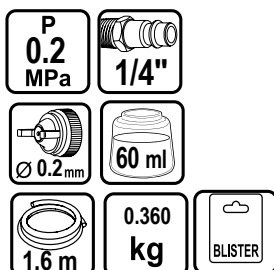

| Art.No | gross weight | in cartoon | barcode |
|--------|--------------|------------|---------------|
| 089935 | 0.490 | 20 | 3800123153327 |

AIR SPRAY GUN FOR POLYURETANE INSULATION RD-PUSG13

[BG] Пистолет за полиуретан • [RO] Pistol de aerisire pentru izolație din poliuretana • [SR] Pištolj za raspršivanje vazduha za izolaciju od poliuretana • [MK] Пневматски распршувач за полиуретанска изолација • [RU] Воздушный распылитель для полиуретановой изоляции • [SL] Pištola za brizganje zraka za izolacijo iz poliuretana • [EL] Αεροβόλο όπλο για μόνωση πολυουρεθάνης • [HR] Puhala za raspršivanje zraka za poliuretansku izolaciju • [FR] Pistolet pneumatique pour isolation en polyuréthane • [IT] Pistola a spruzzo pneumatica • [ES] Pistola pulverizadora de aire para aislamiento de poliuretano • [PT] Pistola pneumática p/ projeção de isolamento poliuretano



WORKING PRESSURE
0.6 MPa

Ø 1.8 mm

| Art.No | gross weight | in cartoon | barcode |
|--------|--------------|------------|---------------|
| 089944 | 0.470 | 20 | 3800972010215 |

AIR GUN GRAVITY RD-SG02

[BG] Пистолет за боя с горно казанче • [RO] Pistol pentru vopsit • [SR] Pištolj za farbanje pneumatski • [MK] Пиштон за фарбање • [RU] Краскопульт • [SL] Brizgalna pištola • [EL] Πιστολι βαφης • [HR] Pištolj za boju • [FR] Bouton pousseur double fonction air brush • [IT] Pulsante a spazzola d'aria a doppia funzione • [ES] Air brush push-button duobla funkcio • [PT] Pistola de pintura c/ corpo

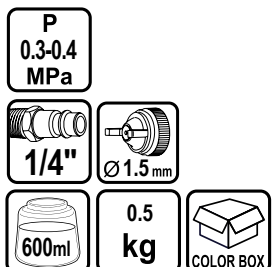

| Art.No | gross weight | in cartoon | barcode |
|--------|--------------|------------|---------------|
| 089909 | 0.600 | 20 | 3800123123177 |

SPRAY GUN GRAVITY

[BG] Пистолет за боя с горно казанче • [RO] Pistol pentru vopsit • [SR] Pištolj za farbanje pneumatski • [MK] Пиштол за фарбање • [RU] Краскопулт • [SL] Brizgalna pištola • [EL] Πιστολι βαφης • [HR] Pištolj za boju • [FR] Bouton pousseur double fonction air brush • [IT] Pulsante a spazzola d'aria a doppia funzione • [ES] Air brush push-button duobla funkcio • [PT] Pistola de pintura c/ copo

RD-SG05

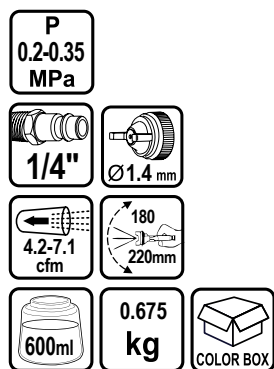

| Art.No | gross weight | in cartoon | barcode |
|--------|--------------|------------|---------------|
| 089934 | 0.920 | 20 | 3800123152238 |

RD-SG04

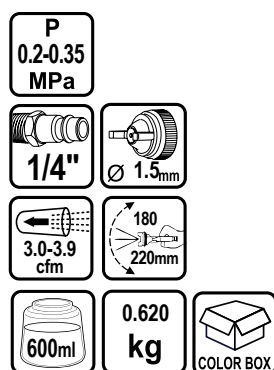

| Art.No | gross weight | in cartoon | barcode |
|--------|--------------|------------|---------------|
| 089933 | 1.100 | 10 | 3800123152221 |

SPRAY GUN GRAVITY Laterally

[BG] Пистолет за боя с горно странично казанче • [RO] Pistol ptr. vopsit • [SR] Pištolj za farbanje pneumatski • [MK] Пиштол за фарбање • [RU] Краскопулт • [SL] Brizgalna pištola • [EL] Πιστολι βαφης • [HR] Pištolj Za Boju • [FR] Pulvériser la gravité du pistolet latéralement • [IT] Pistola a spruzzo Gravità lateralmente • [ES] Spray pafillo graveco flanke • [PT] Pistola de pintura c/ copo

RD-SG03

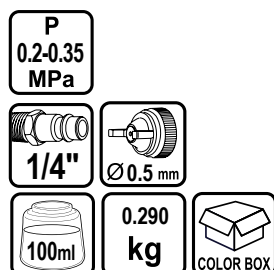

| Art.No | gross weight | in cartoon | barcode |
|--------|--------------|------------|---------------|
| 089910 | 0.490 | 20 | 3800123123184 |

RD-SG12

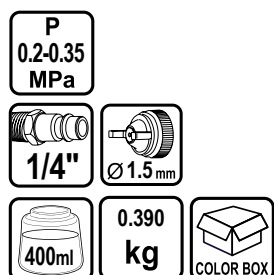

| Art.No | gross weight | in cartoon | barcode |
|--------|--------------|------------|---------------|
| 089943 | 0.750 | 10 | 3800972003507 |

AIR TOOLS 5 PCS KIT SPRAY GUN GRAVITY RD-AT02

[BG] Пистолети за боя горно и за въздух 5 бр. к-т • [RO] Set 5 buc. accesorii compresor • [SR] Alat set 5 kom pneumatski • [MK] Комплет за фарбање 5 ком. • [RU] Набор насадок к компрессору 5 шт
 [SL] Zracni set 5u jednom • [EL] Εργαλεία Αέρος 5 τεμ • [HR] Pištolj Za Boju i Za Ispuhivanje 5 komada postaviti • [FR] Outils pneumatiques 5 pièces kit pistolet à gravité • [IT] Utensili pneumatici 5 pezzi kit pistola a spruzzo a gravità • [ES] 5 komputiloj kit spray pafilon • [PT] 5 pcs kit ferramentas pneumáticas

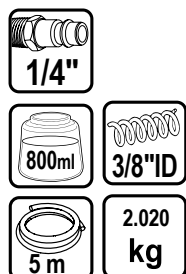

| Art.No | gross weight | in cartoon | barcode |
|--------|--------------|------------|---------------|
| 089913 | 0.660 | 10 | 3800123122231 |



RAIDER[®]

Accessories



COMBINED REGULATOR, AIR FILTER, WATER TRAP & LUBRICATOR RD-AF02

• [BG] Пневмоподготвяща група за пневматична система • [RO] Filtru aer, regulator & lubricator
 • [SR] Priprema grupa • [MK] Отворање на актог за компресор • [RU] Фильтр, регулятор
 смазочных материалов • [SL] Grupa pripravna za zrak • [EL] Φίλτρο αέρος, ρυθμιστής και λιπαντής
 • [HR] Priprema grupa • [FR] Régulateur combiné, filtre à air, piège à eau et graisseur • [IT] Regolatore combinato, filtro aria, separatore d'acqua e lubrificatore
 • [ES] Combinata reguladoro • [PT] Combinata reguladoro



Art. No. 089918
 EAN: 3800123122170

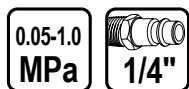

LUBRICATOR M&F RD-A001

• [BG] Омаслител за пневматична система • [RO] Mini dispozitiv de uns • [SR] Zauljivač
 • [MK] Мазалица за подмачување • [RU] Лубрикатор • [SL] Podmazivač [EL] Λιπαντική για пневματικό
 σύστημα • [HR] Mini-podmazivač • [FR] Lubrifiant pour système pneumatique
 • [IT] Lubrificante per sistema pneumatico • [ES] Lubrika por neumática sistema
 • [PT] Lubrificante para sistema pneumático



Art. No. 089938
 EAN: 3800123153402



AIR FILTER & WATER TRAP M&F RD-AF01

• [BG] Влагоуловител за пневматична система M&F • [RO] Mini filtru • [SR] Skupljač vlage za pneumatske
 uređaje • [MK] Воздушен филтер и Стапика за вода • [RU] Воздушный фильтр и водоотделитель • [SL]
 Zračni filter • [EL] Φίλτρο αέρα και νερό παγίδα • [HR] Zračni filter za Vodu • [FR] Désaérateur pour système
 pneumatique • [IT] Disaeratore per sistema pneumatico • [ES] Deaerator por neumática sistema [PT] Desaera-
 dor para sistema pneumático



Art. No. 089917
 EAN: 3800123122002



AIR REGULATOR

• [BG] Редуцир вентил с манометър F • [RO] Regulator de aer F • [SR] Regulator pritiska • [MK] Редуцатор
 на притисок • [RU] Воздушный регулятор • [SL] Zračni regulator • [EL] ρυθμιστής αέρα • [HR] Reducir ventil
 sa manometrom • [FR] Régulateur d'air • [IT] Regolatore d'aria • [ES] Aera reguligilo [PT] Regulador de ar



Art. No. 110601
 EAN: 3800123159299

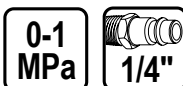

MANOMETER

• [BG] Манометър • [RO] Manometru • [SR] Merač pritiska • [MK] Мерач на притисок • [RU] Манометр
 • [SL] Merlec tiaka • [EL] όργανο πίεσης • [HR] Manometar • [FR] Manomètre • [IT] Manometro
 • [ES] Manometer • [PT] Manómetro



Art. No. 110602
 EAN: 3800123159305



AIR PU HOSE WITH QUICK COUPLINGS M&F RD-CH02

[BG] Маркуч полиуретанов за компресор с бързи връзки • [RO] Furtun compresor •
 [SR] Crevo spiralno za vazduh • [MK] Спирално црево за воздух • [RU] Шланги спиральные
 пневматические [SL] Špiralová hadica • [EL] Σωλήνα αέρος σπирάλ • [HR] Crijevo za kompresor • [FR] Tuyau
 en polyuréthane pour compresseur • [IT] Tubo in poliuretano per compressore •
 [ES] Poliuretano per komponajo [PT] Mangueira de poliuretano para compressor



Art. No. 089919
 EAN: 3800123122033

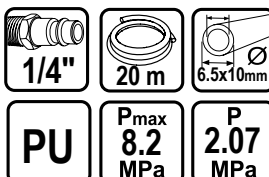

AIR PU SPIRAL HOSE WITH QUICK COUPLINGS M&F

• [BG] Маркуч за компресор полиуретанов с бързи връзки • [RO] Furtun compresor • [SR] Crevo spiralno
 za vazduh • [MK] Спирално црево за воздух • [RU] Шланги спиральные пневматические • [SL] Špiralová
 hadica • [EL] Σωλήνα αέρος σπирάλ [HR] Crijevo za kompresor spiralno • [FR] Tuyau en polyuréthane pour
 compresseur • [IT] Tubo in poliuretano per compressore • [ES] Poliuretano per komponajo • [PT] Mangueira de
 poliuretano para compressor

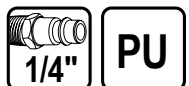

| art. № | Size (Ø) | P (MPa) | P _{max} (MPa) | Lenght (m) | BARCODE |
|--------|-----------|---------|------------------------|------------|---------------|
| 110701 | 6.5x9.5mm | 0.83 | 2.4 | 5 | 3800123159312 |
| 139904 | 6.5x9.5mm | 0.83 | 2.4 | 10 | 3800123123429 |
| 110702 | 8x12mm | 0.83 | 2.4 | 15 | 3800123159329 |
| 110703 | 10x14mm | 0.83 | 2.4 | 15 | 3800123159336 |



AIR QUICK COUPLER MALE THREAD

[BG] Накрайник пневматичен бърза връзка М • [RO] Conector rapid M • [SR] Spojnica muška • [MK] Спојка,
 машини дел • [RU] Штуцер, с внешней резьбой • [SL] Viti sklopke • [EL] Σύνδεσμος, αρσενικό μέρος
 • [HR] Spojnica muška • [FR] Raccord rapide d'air • [IT] Ugello pneumatico • [ES] Pneumática cigaredingo
 • [PT] Bico pneumático



| art. № | Size (") | BARCODE |
|--------|----------|---------------|
| 089937 | 1/2 | 3800123153396 |
| 089927 | 1/4 | 3800123122477 |

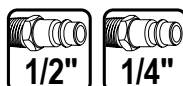

AIR QUICK COUPLER FEMALE THREAD QC02

• [BG] Накрайник пневматичен бърза връзка F • [RO] Conector rapid F • [SR] Spojnica ženska • [MK] Спојка,
 женски дел • [RU] Муфта соединительная, с внутренней резьбой • [SL] Spojka sklopke • [EL] Σύνδεσμος,
 θηλυκό μέρος • [HR] Spojnica ženska • [FR] Raccord rapide d'air • [IT] Ugello pneumatico • [ES] Pneumática
 cigaredingo • [PT] Bico pneumático



Art. No. 089925
 EAN: 3800123122453



AIR QUICK COUPLER

• [BG] Накрайник пневматичен бърза връзка маркуч • [RO] Conector [SR] Spojnica za crevo
 • [MK] Спојка • [RU] Штуцер • [SL] Sklopke • [EL] Σύνδεσμος, αρσενικό μέρος • [HR] Spojnica
 zraka brza crijeva • [FR] Raccord rapide d'air • [IT] Ugello pneumatico • [ES] Pneumática cigared-
 ingo • [PT] Bico pneumático



| art. № | Size(Ø) | BARCODE |
|--------|---------|---------------|
| 089930 | 6mm | 3800123122507 |
| 110901 | 8mm | 3800123159381 |
| 110902 | 10mm | 3800123159398 |



AIR QUICK COUPLER MALE THREAD QC05

• [BG] Накрайник пневматичен бърза връзка М • [RO] Conector rapid M • [SR] Spojnica muška
• [MK] Спojка, машки дел • [RU] Штуцер, с внешней резьбой • [SL] Vitič sklopke • [EL] Σύνδεσμος, αρσενικό μέρος • [HR] Spojnica muška • [FR] Raccords avec filetage mâle • [IT] Raccordi con filetto maschio • [ES] Agordoj kun vira fadeno • [PT] Conexões com rosca macho

Art. No. 089928
EAN: 3800123122484



AIR QUICK COUPLER FEMALE THREAD QC03

• [BG] Накрайник пневматичен бърза връзка F • [RO] Conector rapid F • [SR] Spojnica ženska
• [MK] Спojка, женски дел • [RU] Муфта соединительная, с внутренней резьбой • [SL] Spojka sklopke
• [EL] Σύνδεσμος, θηλυκό μέρος • [HR] Spojnica ženska • [FR] Couplage avec filetage interne
• [IT] Accoppiamento, con filettatura interna • [ES] Kunigo, kun interna fadeno • [PT] Acoplamento, com rosca interna

Art. No. 089926
EAN: 3800123122460



AIR QUICK COUPLER HOSE

• [BG] Накрайник пневматичен за бърза връзка маркуч • [RO] Conector • [SR] Spojnica za crevo
• [MK] Спojка • [RU] Штуцер • [SL] Sklopke • [EL] Σύνδεσμος, αρσενικό μέρος • [HR] Spojnica zraka brza crijeva
• [FR] Raccords • [IT] Ugello pneumatico • [ES] Pneu matika cigaredingo • [PT] Bico pneum tico

| art. № | Size(Ø) | BARCODE |
|--------|---------|---------------|
| 089929 | 6mm | 3800123122491 |
| 110903 | 8mm | 3800123159404 |
| 110904 | 10mm | 3800123159411 |



AIR QUICK COUPLINGS 5PCS KIT QC01

• [BG] Накрайници пневм. за бърза връзка 5 бр. к-т • [RO] 5Pcs/Set conectori • [SR] Spojnica za crevo
• [MK] Спojка сет 5 ком • [RU] Штуцери 5бр • [SL] Sklopke 5 kos • [EL] Σύνδεσμος, αρσενικό μέρος 5 τεμάχια [HR] Spojnica zraka brza 5 kom. postaviti • [FR] Raccords • [IT] Unione • [ES] Fittings • [PT] A articula o da fenda

Art. No. 089912
EAN: 380012312312369

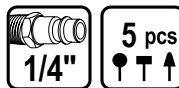

Y-TYPE CONNECTOR F

• [BG] Тройник "Y" F • [RO] Y-Tip conector F • [SR] Ra zna pneumatska ženska • [MK] Спojка Y-тип женски дел • [RU] Тройник Y-образный с внутренней резьбой • [SL] Sklopke Y-type F
• [EL] Σύνδεσμος, αρσενικό μέρος Y-type F • [HR] Tla ni razdjelnik spojnice • [FR] Connecteur de type Y
• [IT] Connettore tipo Y • [ES] Tipo konektilo Y • [PT] Conector tipo Y

Art. No. 110804
EAN: 3800123159374



PLUG FOR HOSE OF INFLATING GUN

• [BG] Накрайник за помпана на гуми за маркуч • [RO] Muf  furtun pentru pistol aer
• [SR] Spojnica za crevo za pi tolja naduvavanje • [MK] Спojка за crevo за пулпање на гуми • [RU] Насадка для накачивания шин шланга • [SL] Sklopke • [EL] Σύνδεσμος, αρσενικό μέρος • [HR] Spojnice za napuhavanje guma za crijeva • [FR] Buse pour gonfler les pneus du tuyau • [IT] Ugello per gonfiare le gomme del tubo • [ES] Borrilo por inflakti la pneu ojn de la maniko • [PT] Bocal para inflar os pneus da mangueira

Art. No. 110906
EAN: 3800123159435



CUTTING DISC FOR METAL

• [BG] Диск за метал • [RO] Disc pentru metal • [SR] Rezna plo a za metal • [MK] Брус камен за метал
• [RU] Диск для резки металла • [SL] Rezalne plo e • [EL] Δίσκοι κοπής μετάλλων
• [HR] Plo e za rezanje metala • [FR] Disque de coupe pour m tal • [IT] Disco da taglio per metallo
• [ES] Tran a disko por metalo maniko • [PT] Tran a Disko por metalo



| art. № | Ø (mm) | Ø ₁ (mm) | D (mm) | BARCODE |
|--------|--------|---------------------|--------|---------------|
| 169904 | 100 | 16 | 1.0 | 3800123143731 |
| 169902 | 100 | 16 | 3.0 | 3800123141928 |
| 169903 | 100 | 16 | 6.0 | 3800123141935 |
| 169901 | 75 | 9.5 | 1.6 | 3800123122514 |



CONICAL REDUCTION

• [BG] Адаптер BPH • [RO] Niplu de reducere dublu • [SR] Nipla reducir dupla • [MK] Адаптер
• [RU] Адаптер • [SL] Adapter • [EL] Προσαρμογέας • [HR] Redukcija pocin ana • [FR] R duction conique
• [IT] Riduzione conica • [ES] Konusa reduktio • [PT] Redu o c nica

| art. № | Size(M / ") | BARCODE |
|--------|-------------|---------------|
| 110806 | 1/2"М-1/4" | 3800123159350 |
| 110805 | 1/2"М-3/8" | 3800123159343 |
| 110803 | 3/8"М-1/4" | 3800123159367 |



STAPLES FOR RD-AS01

• [BG] Скоби за пневматичен такер • [RO] Set capse • [SR] Klamerice za pneumatsku heftalicu • [MK] Муниција за хефталка • [RU] Скобы для пневматического степлера • [SL] Sponke • [EL] Συνοχεύς για σπυραττικ 
• [HR] Klamerice za pneumatska klamerica • [FR] Sauterelles pneumatiques • [IT] Morsetti di inclinazione pneumatici
• [ES] Pneu maj  iltaj abrazoj • [PT] Grampos pneum ticos de inclina o

| art. № | H (mm) | W (mm) | D (mm) | BARCODE |
|--------|--------|--------|--------|---------------|
| 511300 | 6 | 12.8 | 1 | 3800123104831 |
| 511308 | 8 | 12.8 | 1 | 3800123122248 |
| 511309 | 10 | 12.8 | 1 | 3800123122255 |
| 511310 | 12 | 12.8 | 1 | 3800123122262 |
| 511311 | 14 | 12.8 | 1 | 3800123122279 |
| 511312 | 16 | 12.8 | 1 | 3800123122286 |

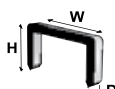

COLOR BOX
5000 PCS

STAPLES FOR RD-AS02

• [BG] Скоби за пневматичен такер • [RO] Set capace • [SR] Klamarice za pneumatsku heftalicu
 • [MK] Муниција за хефталка • [RU] Скобы для пневматического степлера • [SL] Žebelj • [EL] Συνοχές για συρραπτικά • [HR] Klamerice za pneumatska klamerica • [FR] Sauterelles pneumatiques • [IT] Morsetti di inclinazione pneumatici • [ES] Pneuñmaj tiltaj abrazoj • [PT] Grampos pneumáticos de inclinação

| art. № | H (mm) | W (mm) | D (mm) | BARCODE |
|--------|--------|--------|--------|---------------|
| 511330 | 16 | 5.7 | 1.2 | 3800123139710 |
| 511317 | 25 | 5.7 | 1.2 | 3800123122521 |
| 511318 | 32 | 5.7 | 1.2 | 3800123122538 |
| 511350 | 40 | 5.7 | 1.2 | 3800123171574 |

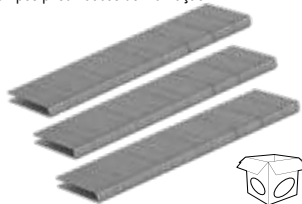

NAILS FOR RD-AS02

• [BG] Пирони за пневматичен такер • [RO] Set capace pentru [SR] Klamarice za pneumatsku heftalicu
 • [MK] Муниција за хефталка • [RU] Скобы для пневматического степлера
 • [SL] Sponke • [EL] Συνοχές για συρραπτικά • [HR] Klamerice za pneumatska klamerica
 • [FR] Sauterelles pneumatiques • [IT] Morsetti di inclinazione pneumatici • [ES] Pneuñmaj tiltaj abrazoj
 • [PT] Grampos pneumáticos de inclinação

| art. № | H (mm) | D (mm) | BARCODE |
|--------|--------|--------|---------------|
| 511313 | 15 | 1 | 3800123122293 |
| 511314 | 25 | 1 | 3800123122309 |
| 511315 | 35 | 1 | 3800123122316 |
| 511316 | 45 | 1 | 3800123122323 |



STAPLES FOR RD-AS03, RD-AS04

• [BG] Скоби за пневматичен такер • [RO] Set capace pentru • [SR] Klamerice za pneumatsku heftalicu
 • [MK] Муниција за хефталка • [RU] Скобы для пневматического степлера • [SL] Sponke • [EL] Συνοχές για συρραпτικά • [HR] Klamerice za pneumatska klamerica • [FR] Agrafes pour agrafeuse pneumatique
 • [IT] Graffette per cucitrice pneumatica • [ES] Staples por pneumatica stapilo • [PT] Grampos para grampeador pneumático

| art. № | H (mm) | W (mm) | D (mm) | Pcs | BARCODE |
|--------|--------|--------|--------|-------|---------------|
| 511401 | 6 | 9.1 | 0.7 | 10000 | 3800972002340 |
| 511402 | 8 | 9.1 | 0.7 | 10000 | 3800972002357 |
| 511403 | 10 | 9.1 | 0.7 | 10000 | 3800972002364 |
| 511404 | 12 | 9.1 | 0.7 | 10000 | 3800972002371 |
| 511405 | 14 | 9.1 | 0.7 | 10000 | 3800972002388 |
| 511406 | 16 | 9.1 | 0.7 | 10000 | 3800972002395 |
| 511407 | 10 | 10 | 1.2 | 5000 | 3800972010338 |
| 511408 | 12 | 10 | 1.2 | 5000 | 3800972010345 |
| 511409 | 14 | 10 | 1.2 | 5000 | 3800972010352 |
| 511410 | 16 | 10 | 1.2 | 5000 | 3800972010369 |
| 511411 | 20 | 10 | 1.2 | 5000 | 3800972010376 |



DRILL BITS HSS SET

• [BG] Сврџна за метал HSS к-т • [RO] Burghiu HSS Pcs/Set • [SR] Burgija hss set • [MK] Бургија за метал
 • [RU] Набор сверла по металлу • [SL] Set svrdrov • [EL] Τρυπάνια για μέταλλο • [HR] Set svrdla za metal HSS
 • [FR] Forets à métaux HSS • [IT] Punte per metallo HSS • [ES] Metalaj taladraj bitoj HSS
 • [PT] Brocas de metal HSS

| art. № | Ø (mm) | drills/ pcs | BARCODE |
|--------|---------|--|---------------|
| 157104 | 1.5-6.5 | 13 pcs 1.5, 2, 2.5, 3, 3.2, 3.5, 4, 4.5, 4.8, 5, 5.5, 6, 6.5mm | 3800123101724 |
| 157105 | 1-10 | 19 pcs 1, 1.5, 2, 2.5, 3, 3.5, 4, 4.5, 5, 5.5, 6, 6.5, 7, 7.5, 8, 8.5, 9, 9.5, 10 mm | 3800123101731 |

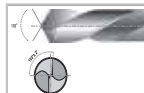

DRILL BITS SET HSS+TIN (TITANIUM NITRIDE)

• [BG] Сврџна за метал к-т HSS+TIN (титанов нитрид) • [RO] Burghiu HSS Titanium Plated
 • [SR] Burgija hss+tin • [MK] Бургија за метал hss+tin • [RU] Набор сверла по металлу
 • [SL] Set svrdrov • [EL] Τρυπάνια για μέταλλο • [HR] Set svrdla za metal HSS • [FR] Forets à métaux HSS
 • [IT] Punte per metallo HSS • [ES] Metalaj taladraj bitoj HSS • [PT] Brocas de metal HSS

| art. № | Ø (mm) | drills/ pcs | BARCODE |
|--------|--------|--|---------------|
| 157107 | 2-8 | 13 pcs 2, 2.5, 3, 3.5, 4, 4.5, 5, 5.5, 6, 6.5, 7, 7.5, 8 mm | 3800123101755 |
| 157108 | 1-10 | 19 pcs 1, 1.5, 2, 2.5, 3, 3.5, 4, 4.5, 5, 5.5, 6, 6.5, 7, 7.5, 8, 8.5, 9, 9.5, 10 mm | 3800123101762 |

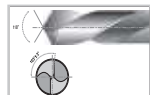

DRILL BITS SET HSS+R

• [BG] Сврџна за метал к-т HSS+R • [RO] Burghiu HSS+R Pcs/Set • [SR] Burgija HSS+R kom./set
 • [MK] Бургија за метал HSS+R бр/сет • [RU] Набор сверла по металлу • [SL] Set svrdrov
 • [EL] Τρυπάνια για μέταλλο • [HR] Set svrdla za metal HSS+R • [FR] Forets à métaux HSS
 • [IT] Punte per metallo HSS • [ES] Metalaj taladraj bitoj HSS • [PT] Brocas de metal HSS

| art. № | Ø (mm) | drills/ pcs | BARCODE |
|--------|--------|---|---------------|
| 157110 | 2-8 | 6 pcs 2, 3, 4, 5, 6, 8 mm | 3800123168482 |
| 157111 | 1-10 | 10 pcs 1, 2, 3, 4, 5, 6, 7, 8, 9, 10 mm | 3800123168499 |



DRILL BITS FOR METAL 15 PCS SET HSS+TIN

[BG] Сврџна за метал 15 бр. к-т • [RO] Burghiu 15 Pcs/Set • [SR] Burgija HSS+TIN 15 kom./set
 • [MK] Бургија за метал 15 бр/сет • [RU] Набор сверла по металлу • [SL] Set svrdrov 15 del
 • [EL] Τρυπάνια για μέταλλο 15 τεμ • [HR] Set svrdla za metal 15 kom [FR] Forets à métaux • [IT] Punte per metallo • [ES] Metalaj taladraj bitoj • [PT] Brocas de metal

Art. No. 157789
 EAN: 3800123169540
Ø 1.5-10mm
 DRILLS 10 pcs:
 Ø1.5x2, 2.0x2, 2.5x2, 3.0, 3.2, 3.5, 4.0, 4.5, 5.0, 6.0, 8.0, 10.0mm



DRILL BITS FOR METAL & CONCRETE 17 PCS SET

[BG] Сврџна за метал и бетон 17 бр. к-т • [RO] Burghiu pentru metal și beton • [SR] Burgija za metal i beton 17 kom./set • [MK] Бургија за метал и бетон 17 бр/сет • [RU] Набор сверла по металлу и бетону 17 шт • [SL] Set svrdrov kovine in beton 17 del • [EL] Τρυπάνια για μέταλλο και σκυρόδεμα 17 τεμ • [HR] Set svrdla za metal i beton 17 kom • [FR] Forets pour le métal et le béton • [IT] Trapani per metallo e calcestruzzo • [ES] Drijo por metallo kaj betono • [PT] Brocas para metal e betão

Art. No. 157796
 EAN: 3800123169618
Ø 1.5-10mm
 Metal 12 pcs: Ø1.5, 2.0, 2.5, 3.0, 3.2, 3.5, 4.0, 4.5, 4.8, 5.0, 5.5, 6.0mm
 Concrete 5 pcs: Ø3.0, 5.0, 6.0, 8.0, 10.0mm



DRILL BIT HSS+R

[BG] Свърдело за метал HSS+R • [RO] Burghiu HSS+R • [SR] Burgija HSS+R • [MK] Бургџија за метал HSS+R • [RU] Сверло по металлу HSS+R • [SL] Sveder HSS+R • [EL] Τρυπάνι για μέταλλα HSS+R • [HR] Svrdla za zidove, okrugli prihvat HSS+R • [FR] Forets à métaux HSS • [IT] Punte per metallo HSS • [ES] Metalaj taladraj bitoj HSS • [PT] Brocas de metal HSS

| art. № | D1 (mm) | L1 (mm) | L2 (mm) | Qty (pcs) | BARCODE |
|--------|---------|---------|---------|-----------|---------------|
| 157678 | 1.0 | 34 | 12 | 2 | 3800123168505 |
| 157679 | 1.5 | 40 | 18 | 2 | 3800123168512 |
| 157680 | 2.0 | 49 | 24 | 2 | 3800123168529 |
| 157681 | 2.5 | 57 | 30 | 2 | 3800123168536 |
| 157682 | 3.0 | 61 | 33 | 2 | 3800123168543 |
| 157683 | 3.2 | 65 | 36 | 2 | 3800123168550 |
| 157684 | 3.5 | 70 | 39 | 2 | 3800123168567 |
| 157685 | 4.0 | 75 | 43 | 2 | 3800123168574 |
| 157686 | 4.2 | 75 | 43 | 1 | 3800123168581 |
| 157687 | 4.5 | 80 | 47 | 1 | 3800123168598 |
| 157688 | 5.0 | 86 | 52 | 1 | 3800123168604 |
| 157689 | 6.0 | 93 | 57 | 1 | 3800123168611 |
| 157690 | 6.5 | 101 | 63 | 1 | 3800123168628 |
| 157691 | 7.0 | 109 | 69 | 1 | 3800123168635 |
| 157692 | 8.0 | 117 | 75 | 1 | 3800123168642 |
| 157693 | 10.0 | 133 | 87 | 1 | 3800123168659 |
| 157694 | 12.0 | 151 | 101 | 1 | 3800123168666 |

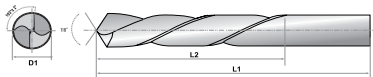

STEP DRILL BIT SPIRAL FLUTE HSS+TIN

[BG] Свърдело за ламарина стъпаловидно HSS+TIN • [RO] Burghiu HSS+TIN • [SR] Burgija HSS+TIN • [MK] Бургџија за метал HSS+TIN • [RU] Набор сверла по металлу HSS+TIN • [SL] Sveder HSS+TIN • [EL] Τρυπάνια για μέταλλα HSS+TIN • [HR] Set svrdla za metal HSS+TIN • [FR] Perceuse pour tôle HSS+TIN • [IT] Trapano per lamiera HSS+TIN • [ES] Taladros HSS+TIN • [PT] Broca para metal de folha HSS+TIN

| art. № | Ø(mm) | HEX | BARCODE |
|--------|-------|------|---------------|
| 150678 | 4-12 | 1/4" | 3800972004986 |
| 150679 | 4-20 | 1/4" | 3800972004993 |
| 150680 | 6-30 | 1/4" | 3800972005006 |



DRILL BIT HSS TIN

[BG] Свърдело за метал HSS • [RO] Burghiu HSS • [SR] Burgija HSS • [MK] Бургџија за метал HSS • [RU] Сверло по металлу HSS • [SL] Sveder HSS • [EL] Τρυπάνι για μέταλλα HSS • [HR] Svrdal za metal HSS • [FR] Forets à métaux HSS • [IT] Punte per metallo HSS • [ES] Metalaj taladraj bitoj HSS • [PT] Brocas de metal HSS

| art. № | D1 (mm) | L1 (mm) | L2 (mm) | Qty (pcs) | BARCODE |
|--------|---------|---------|---------|-----------|---------------|
| 150655 | 1.0 | 34 | 12 | 2 | 3800123164262 |
| 150656 | 1.5 | 40 | 18 | 2 | 3800123164279 |
| 150657 | 2.0 | 49 | 24 | 2 | 3800123164286 |
| 150658 | 2.5 | 57 | 30 | 2 | 3800123164293 |
| 150659 | 3.0 | 61 | 33 | 2 | 3800123164309 |
| 150660 | 3.2 | 65 | 36 | 2 | 3800123164316 |
| 150661 | 3.5 | 70 | 39 | 2 | 3800123164323 |
| 150662 | 4.0 | 75 | 43 | 2 | 3800123164330 |
| 150663 | 4.2 | 75 | 43 | 1 | 3800123164347 |
| 150664 | 4.5 | 80 | 47 | 1 | 3800123164354 |
| 150665 | 4.8 | 86 | 52 | 1 | 3800123164361 |
| 150666 | 5.0 | 86 | 52 | 1 | 3800123164378 |
| 150667 | 5.5 | 93 | 57 | 1 | 3800123164385 |
| 150668 | 6.0 | 93 | 57 | 1 | 3800123164392 |
| 150669 | 6.5 | 101 | 63 | 1 | 3800123164408 |
| 150670 | 7.0 | 109 | 69 | 1 | 3800123164415 |
| 150671 | 8.0 | 117 | 75 | 1 | 3800123164422 |
| 150672 | 8.5 | 117 | 75 | 1 | 3800123164439 |
| 150673 | 9.0 | 125 | 81 | 1 | 3800123164446 |
| 150674 | 10.0 | 133 | 87 | 1 | 3800123164453 |
| 150675 | 11.0 | 142 | 94 | 1 | 3800123164460 |
| 150676 | 12.0 | 151 | 101 | 1 | 3800123164477 |
| 150677 | 13.0 | 151 | 101 | 1 | 3800123164484 |

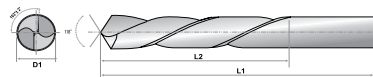

DIN 338

HSS+TIN SPLIT POINT TYPE C



DRILL BITS 6 PCS SET HSS-CO

[BG] Свърделна за метал 6 бр. к-т HSS-Co • [RO] Burghiu HSS-Co 6 Pcs/Set • [SR] Burgija HSS-Co 6 kom./set • [MK] Бургџија за метал HSS-Co 6 бр/сет • [RU] Набор сверла по металлу 6 шт HSS-Co • [SL] Set svdrov HSS-Co 6 del • [EL] Τρυπάνια για μέταλλα HSS-Co 6 τεμ • [HR] Set svrdla za metal HSS-Co 6 kom • [FR] Forets à métaux HSS-Co • [IT] Punte per metallo HSS-Co • [ES] Metalaj taladraj bitoj HSS-Co • [PT] Brocas de metal HSS-Co

Art. No. 157112
EAN: 3800123168673

Ø2-8mm
DRILLS
6 pcs: 2, 3, 4, 5, 6, 8 mm

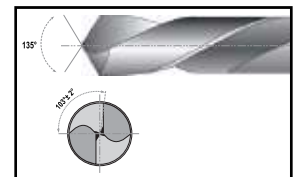

DRILL BIT HSS-CO

[BG] Свърдело за метал HSS-Co • [RO] Burghiu HSS-Co • [SR] Burgija HSS-Co • [MK] Бургија за метал HSS-Co • [RU] Сверло по металлу HSS-Co • [SL] Sveder HSS-Co • [EL] Τρυπάνι για μέταλλα HSS-Co • [HR] Svrdal za metal HSS-Co • [FR] Forets à métaux HSS-Co • [IT] Punte per metallo HSS-Co • [ES] Metalaj taladraj bitoj HSS-Co • [PT] Brocas de metal HSS-Co

| art. № | D1 (mm) | L1 (mm) | L2 (mm) | Qty (pcs) | BARCODE |
|--------|---------|---------|---------|-----------|---------------|
| 157695 | 2.0 | 49 | 24 | 2 | 3800123168680 |
| 157696 | 2.5 | 57 | 30 | 2 | 3800123168697 |
| 157697 | 3.0 | 61 | 33 | 2 | 3800123168703 |
| 157698 | 3.2 | 65 | 36 | 2 | 3800123168710 |
| 157699 | 3.5 | 70 | 39 | 2 | 3800123168727 |
| 157700 | 4.0 | 75 | 43 | 2 | 3800123168734 |
| 157715 | 4.2 | 75 | 43 | 1 | 3800123168741 |
| 157716 | 4.5 | 80 | 47 | 1 | 3800123168758 |
| 157717 | 5.0 | 86 | 52 | 1 | 3800123168765 |
| 157718 | 6.0 | 93 | 57 | 1 | 3800123168772 |
| 157719 | 6.5 | 101 | 63 | 1 | 3800123168789 |
| 157720 | 7.0 | 109 | 69 | 1 | 3800123168796 |
| 157721 | 8.0 | 117 | 75 | 1 | 3800123168802 |
| 157722 | 10.0 | 133 | 87 | 1 | 3800123168819 |
| 157723 | 12.0 | 151 | 101 | 1 | 3800123168826 |



COBALT

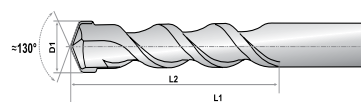
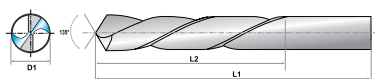

MASONRY DRILL BITS 5 PCS SET

[BG] Свърдела за бетон 5 бр. комплект • [RO] 5Pcs/Set burghie • [SR] Burgija za zid Set 5 kom • [MK] Бургија сет 5 ком [RU] Сверло по бетону набор 5 шт • [SL] Sveder za beton nabor 5 kos • [EL] Τρυπάνι για το σκυρόδεμα сет 5 τεμαχίων • [HR] Svrdla za zidove 5kom • [FR] Forets de maçonnerie • [IT] Bit di perforazione in muratura • [ES] Konkretaj triloj • [PT] Brocas de concreto

Ø 4, 5, 6, 8, 10mm

Art. No. 157113
EAN: 3800123168833

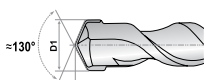

MASONRY DRILL BITS 15 PCS SET

[BG] Свърдела за бетон 15 бр. комплект • [RO] 15 Pcs/Set burghie • [SR] Burgija za zid Set 15 kom • [MK] Бургија сет 15 ком • [RU] Сверло по бетону набор 15 шт • [SL] Sveder za beton nabor 15 kos • [EL] τρυπάνι για το σκυρόδεμα сет 15 τεμαχίων • [HR] Svrdla za zidove 15kom • [FR] Forets de maçonnerie • [IT] Bit di perforazione in muratura • [ES] Konkretaj triloj • [PT] Brocas de concreto

Ø 3-10mm

Masonry Drills 15 pcs:
3.0x3, 4.0x3, 5.0x3,
6.0x2, 8.0x2, 10.0x2



Art. No. 157790
EAN: 3800123169557

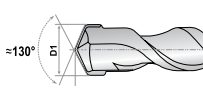

BRAD POINT DRILL BITS FOR WOOD 5 PCS SET

[BG] Свърдела за дърво 5 бр. к-т • [RO] Burghiu ptr lemn 5 buc/Set • [SR] Burgija za drvo 5 kom./set • [MK] Бургија за дрво 5 бр/сет • [RU] Набор сверла по дереву 5 шт. • [SL] Set svedrov lesa 5 del • [EL] Τρυπάνια για ξύλο 5 τεμ • [HR] Set svrdla za drvo 5kom • [FR] Jeu de forets pour bois • [IT] Set di punte per legno • [ES] Aro da taladraj por ligno • [PT] Conjunto de brocas para madeira

Ø 4, 5, 6, 8, 10mm

Art. No. 157114
EAN: 3800123168918

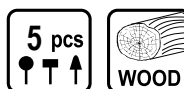

BRAD POINT DRILL BITS FOR WOOD 15 PCS SET

[BG] Свърдела за дърво 15 бр. к-т • [RO] Burghiu ptr lemn 15 buc/Set • [SR] Burgija za drvo 15 kom./set • [MK] Бургија за дрво 15 бр/сет • [RU] Набор сверла по дереву 15 шт. • [SL] Set svedrov lesa 15 del • [EL] Τρυπάνια για ξύλο 15 τεμ • [HR] Set svrdla za drvo 15kom • [FR] Jeu de forets pour bois • [IT] Set di punte per legno • [ES] Aro da taladraj por ligno • [PT] Conjunto de brocas para madeira

Ø 3, 3.5, 4, 4.5, 5, 5.5, 6, 6.5, 7, 8, 10mm

DRILLS 15 pcs:
Ø3.0x3, 3.5x2, 4.0x2,
4.5, 5.0, 5.5, 6.0, 6.5,
7.0, 8.0, 10.0mm

Art. No. 157791
EAN: 3800123169564

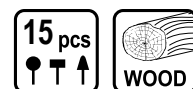

BRAD POINT DRILL BITS FOR WOOD

[BG] Свърделно за дърво • [RO] Burghiu pentru lemn • [SR] Burgija za drvo • [MK] Бургџија за дрво
 • [RU] Сверла по древо • [SL] Svedro lesa • [EL] Τρυπάνια για ξύλο • [HR] Svrđalo za drvo
 • [FR] Jeu de forets pour bois • [IT] Set di punte per legno • [ES] Aro da taladroj por ligno
 • [PT] Conjunto de brocas para madeira

| art. № | Ø (mm) | BARCODE |
|--------|--------|---------------|
| 157731 | Ø3 | 3800123168925 |
| 157732 | Ø4 | 3800123168932 |
| 157733 | Ø5 | 3800123168949 |
| 157734 | Ø6 | 3800123168956 |
| 157736 | Ø8 | 3800123168970 |
| 157737 | Ø10 | 3800123168987 |
| 157738 | Ø12 | 3800123168994 |



FLAT SPEED SPADE BITS FOR WOOD 1/4" HEX SHANK

[BG] Свърделна за дърво плоски 1/4" hex • [RO] Burghiu ptr lemn 1/4" hex • [SR] Burgija za drvo 1/4" hex • [MK] Бургџија за дрво 1/4" hex • [RU] Набор сверла по древо 1/4" hex • [SL] Set svedrov lesa 1/4" hex • [EL] Τρυπάνια για ξύλο 1/4" hex • [HR] Set svrdla za drvo 1/4" hex • [FR] Jeu de forets pour bois • [IT] Set di punte per legno • [ES] Aro da taladroj por ligno • [PT] Conjunto de brocas para madeira

| art. № | Ø (mm) | BARCODE |
|--------|--------|---------------|
| 157739 | Ø14 | 3800123169014 |
| 157740 | Ø16 | 3800123169021 |
| 157741 | Ø20 | 3800123169038 |
| 157742 | Ø22 | 3800123169045 |
| 157743 | Ø25 | 3800123169052 |
| 157744 | Ø28 | 3800123169069 |
| 157745 | Ø30 | 3800123169076 |



GLASS AND TILE DRILL BITS 5 PCS SET

[BG] Свърделна за стъкло 5 броя к-т • [RO] Burghiu ptr sticlă 5 buc/Set • [SR] Burgija za staklo 5 kom./set • [MK] Бургџија за стакло 5 бр/сет • [RU] Набор сверла по стакло 5 шт. • [SL] Set svedrov steklo 5 del • [EL] Τρυπάνια για ποτήρι 5 τεμ • [HR] Set svrdla za staklo 5 kom • [FR] Set de perceuse à verre • [IT] Trapano fissato su vetro • [ES] Fiksita pilko • [PT] Conjunto de broca de vidro

Art. No. 157798

EAN: 3800123169632

Ø 3-10mm

DRILLS 5 pcs: Ø3.0, 4.0, 6.0, 8.0, 10.0mm



Ceramic



GLASS AND TILE DRILL BITS 3 PCS SET

[BG] Свърделна за стъкло 3 броя к-т • [RO] Burghiu ptr sticlă 3 buc/Set • [SR] Burgija za staklo 3 kom./set • [MK] Бургџија за стакло 3 бр/сет • [RU] Набор сверла по стакло 3 шт. • [SL] Set svedrov steklo 3 del • [EL] Τρυπάνια για ποτήρι 3 τεμ • [HR] Set svrdla za staklo 3 kom • [FR] Set de perceuse à verre • [IT] Trapano fissato su vetro • [ES] Fiksita pilko • [PT] Conjunto de broca de vidro

Art. No. 157115

EAN: 3800123169250

Ø 5-8mm

DRILLS 3 pcs: Ø5.0, 6.0, 8.0mm



Ceramic



GLASS AND TILE DRILL BIT

[BG] Свърделно за стъкло • [RO] Burghiu ptr sticlă • [SR] Burgija za staklo • [MK] Бургџија за стакло
 • [RU] Сверло для стекла • [SL] Svedro za steklo • [EL] Τρυπάνι για ποτήρι • [HR] Svrđalo za staklo i keramike • [FR] Set de perceuse à verre • [IT] Trapano fissato su vetro • [ES] Fiksita pilko • [PT] Conjunto de broca de vidro

| art. № | Ø (mm) | BARCODE |
|--------|--------|---------------|
| 157763 | Ø3 | 3800123169267 |
| 157764 | Ø4 | 3800123169274 |
| 157765 | Ø5 | 3800123169281 |
| 157766 | Ø6 | 3800123169298 |
| 157767 | Ø8 | 3800123169304 |
| 157768 | Ø10 | 3800123169311 |
| 157769 | Ø12 | 3800123169328 |



Ceramic



ADAPTOR FROM SDS-MAX TO SDS-PLUS

[BG] Адаптер от SDS-max към SDS-plus • [RO] Adaptor de la SDS MAX-SDS PLUS • [SR] Adapter sa SDS- mak da SDS -plus • [MK] Адаптер • [RU] Адаптер с SDS-Max на SDS-Plus • [SL] Adapter iz SDS-max, da SDS-plus • [EL] Μετατροπέας SDS-max σε SDS-plus • [HR] SDS-MAX Adapter • [FR] Adaptateur avec SDS-Max à SDS-Plus • [IT] Adattatore con SDS-Max a SDS-Plus • [ES] Adaptilo kun SDS-Max al SDS-Plus • [PT] Adaptador com SDS-Max para SDS-Plus



Art. No. 159916
EAN: 3800123141805



HOLESAW ARBOR SDS-PLUS WITH PILOT MASONRY DRILL BIT

[BG] Водач SDS-plus за боркорона • [RO] Tijă conectoare SDS-PLUS • [SR] Vodilica za kruna • [MK] Водач за круна за бетон за торна SDS+ • [RU] Бур за Колонковая бур фреза • [SL] Vodič za krona za vrtanje betona • [EL] Οδηγός τριπόντι SDS-plus • [HR] Nosač s svrdlom za centriranje • [FR] Couronne carbure pour béton SDS-plus • [IT] Corona per metallo duro per calcestruzzo SDS-plus • [ES] Krono por karburo por betono SDS-plus • [PT] Coroa de carboneto para betão SDS-plus

| art. № | SDS | length | BARCODE |
|--------|------|--------|---------------|
| 154811 | plus | 200 | 3800123102516 |
| 154805 | plus | 300 | 3800123122705 |
| 157801 | plus | 500 | 3800123162725 |
| 157802 | max | 500 | 3800123163777 |



CHISELS SDS-PLUS 3 PCS. SET

[BG] Длета SDS-plus 3 броя к-т • [RO] 3Pcs/Set dalti SDS • [SR] Sekači 3 kom Set SDS-plus • [MK] Длета SDS-plus 3 ком сет • [RU] Набор долота SDS плюс 3 шт. • [SL] Sekači 3 kos Set • [EL] Σετ SDS PLUS 3 τεμαχίων • [HR] SDS-Plus Dlijeto 3kom • [FR] SDS jeu de ciseaux SDS plus • [IT] Set di scalpelli SDS plus • [ES] SDS čizilo aro plus • [PT] Conjunto de cinzel SDS mais

Art. No. 159904
EAN: 3800123125263



TILE CHISEL SDS-PLUS

[BG] Длето-лопатка SDS-plus • [RO] Dalta lata SDS-plus • [SR] Sekač SDS-plus • [MK] Длето SDS-plus • [RU] Долото широкое SDS-PLUS • [SL] Dleto SDS-plus • [EL] Καλέμι διαβάθμισης • [HR] Široko dlijeto hex • [FR] SDS-PLUS burin large • [IT] Praticare un po 'di bit SDS-PLUS • [ES] SDS-PLUS larǵa čizilo • [PT] Formão largo SDS-PLUS

| art. № | L1/mm | D1/mm | D2/mm | BARCODE |
|--------|-------|-------|-------|---------------|
| 154007 | 250 | 40 | 14 | 3800123159985 |
| 154008 | 250 | 40 | 14 | 3800972002524 |

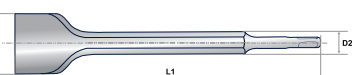

CARBIDE CORE CUTTER WITH HOLESAW ARBOR&PILOT MASONRY DRILL BIT

[BG] Боркорона за бетон с водач и сверло • [RO] Adaptor pentru freza cu miez din carbura [SR] Adapter gezač jezgre od karbida • [MK] Адаптер за сеченье карбид • [RU] Адаптер твердосплавный резак • [SL] Adapter rezkar za jedro iz karbida • [EL] Μετατροπέας καρβιδίου [HR] Rezač jezgre od karbidne jezgre • [FR] Fraise à nouau en carbure • [IT] AFresa in metallo duros • [ES] Karburilo kerna trancilo • [PT] Cortador de núcleo de metal duro

| art. № | Ø (mm) | BARCODE |
|--------|--------|---------------|
| 154812 | Ø30 | 3800972016729 |
| 154813 | Ø35 | 3800972016736 |
| 154814 | Ø45 | 3800972016743 |
| 154815 | Ø65 | 3800972016750 |
| 154816 | Ø85 | 3800972016767 |
| 154817 | Ø130 | 3800972016774 |

NEW PRODUCT



HOLLOW GOUGING CHISEL SDS-PLUS

[BG] Длето-каналоконател SDS-plus • [RO] Dalta scobit SDS-PLUS • [SR] Sekač kanalni SDS-plus • [MK] Длето за канал • [RU] Долото SDS-PLUS • [SL] Dleto za kanal • [EL] Καλέμι αυλακώσεων SDS-Plus • [HR] Dlijeto za utore • [FR] Achat de SDS-PLUS • [IT] Scalpello scavato per scalpello SDS-plus • [ES] Hollow Gouging Chisel SDS-plus • [PT] Cinzel de cinzelamento oco SDS-plus

| art. № | L1/mm | D1/mm | D2/mm | BARCODE |
|--------|-------|-------|-------|---------------|
| 154001 | 250 | 23 | 14 | 3800123125645 |
| 154002 | 250 | 23 | 17 | 3800123125645 |

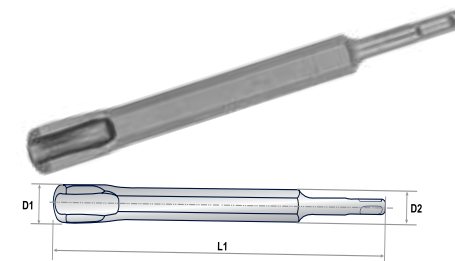

FLAT CHISEL SDS-PLUS

[BG] Длето-сечак SDS-plus • [RO] Dalta SDS-PLUS • [SR] Sekač SDS-plus • [MK] Длето SDS-plus • [RU] Долото SDS-PLUS • [SL] Dleto SDS-plus • [EL] Καλέμι διαβάθμισης • [HR] Plosnato dlijeto • [FR] SDS-PLUS burin • [IT] Scalpello SDS-PLUS • [ES] SDS-PLUS čizilo • [PT] Formão SDS-PLUS

| art. № | L1/mm | D1/mm | D2/mm | BARCODE |
|--------|-------|-------|-------|---------------|
| 154003 | 250 | 20 | 14 | 3800123125638 |
| 154010 | 250 | 20 | 14 | 3800972005020 |
| 154004 | 250 | 23 | 17 | 3800123125669 |

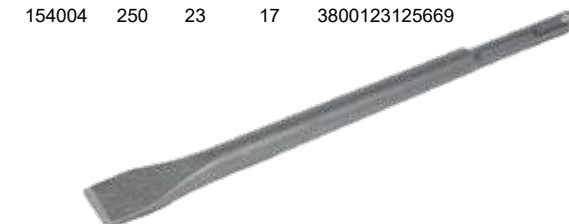

POINT CHISEL SDS-PLUS

[BG] Длето-шило SDS-plus • [RO] Spit SDS-PLUS • [SR] Špic SDS-plus • [MK] Длето остро SDS-plus • [RU] Долото пика SDS-PLUS • [SL] Dleto konica SDS-plus • [EL] Βελόνη SDS-plus • [HR] Šiljato dljeto hex • [FR] Burin de pointe SDS-PLUS • [IT] Scalpello di punta SDS-PLUS • [ES] SDS-PLUS pinta čizilo • [PT] Bit de pico SDS-PLUS

| art. № | L1/ mm | D1/ mm | BARCODE |
|--------|-----------|-----------|---------------|
| 154005 | 250 | 14 | 3800123125621 |
| 154009 | 250 | 14 | 3800972005013 |
| 154006 | 250 | 17 | 3800123125652 |

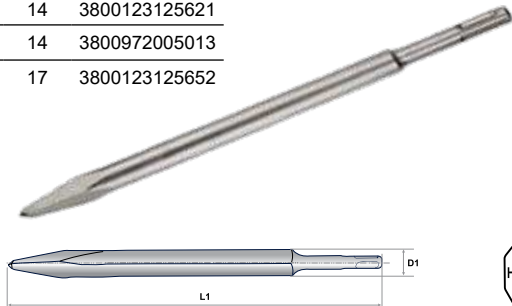

TILE CHISEL SDS-MAX

[BG] Длето-лопатка SDS-max • [RO] Dalta lata SDS-max • [SR] Sekač SDS-max • [MK] Длето SDS-max • [RU] Долото широкое SDS-max • [SL] Dleto SDS-max • [EL] Καλέμι διαβάθμισης SDS-max • [HR] Široko dljeto • [FR] SDS-PLUS burin large • [IT] Praticare un po' di bit SDS-PLUS • [ES] SDS-PLUS larğa čizilo • [PT] Formão largo SDS-PLUS

Art. No. 154201
EAN: 3800123145049



L1: 300mm
D1: 50mm
D2: 18mm

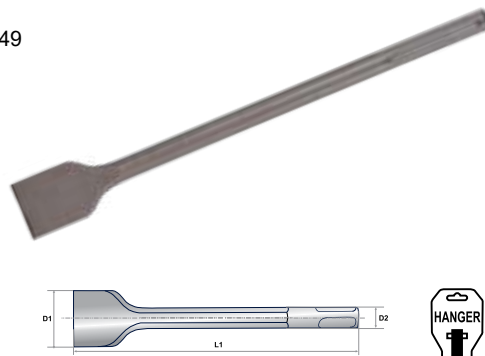

FLAT CHISEL SDS-MAX

[BG] Длето-секач SDS-max • [RO] Dalta SDS-max • [SR] Sekač SDS-max • [MK] Длето SDS-max • [RU] Долото SDS-max • [SL] Dleto SDS-max • [EL] Καλέμι διαβάθμισης • [HR] Plosnato dljeto • [FR] SDS-max burin • [IT] Scalpello SDS-max • [ES] SDS-max čizilo • [PT] Formão SDS-max

Art. No. 154202
EAN: 3800123145032



L1: 400mm
D1: 25mm
D2: 18mm

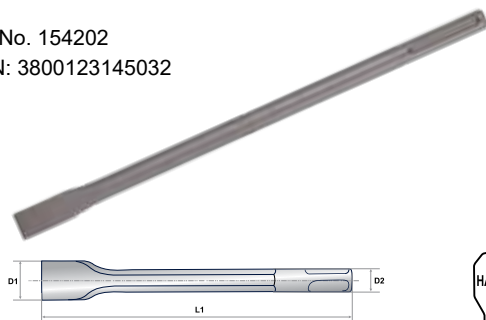

POINT CHISEL SDS-MAX

[BG] Длето-шило SDS-max • [RO] Spit SDS-max • [SR] Špic SDS-max • [MK] Длето остро SDS-max • [RU] Долото пика SDS-max • [SL] Dleto konica SDS-max • [EL] βελόνη SDS-max • [HR] Šiljato dljeto • [FR] Le bit de pointe SDS-max • [IT] Scalpello di punta SDS-max • [ES] La pinta SDS-max • [PT] Pico SDS-max

Art. No. 154203
EAN: 3800123145025



L1: 400mm
D1: 18mm

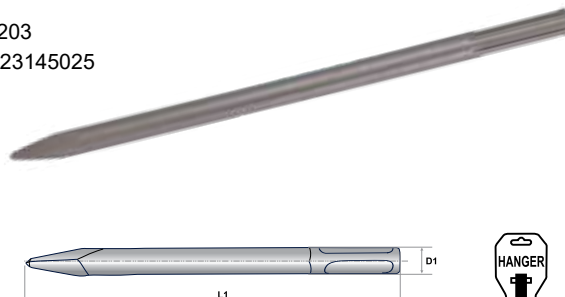

HOLLOW GOUGING CHISEL

[BG] Длето-каналокопател SDS-max • [RO] Dalta pentru canale SDS-max • [SR] Šuplje dleto SDS-max • [MK] Длето остро SDS-max • [RU] Долото SDS-max • [SL] Dleto konica SDS-max • [EL] SDS-max σμίλη • [HR] Šiljato dljeto • [FR] Burin SDS-max • [IT] Scalpello SDS-max • [ES] SDS-max čizilo • [PT] Cinzel SDS-max

Art. No. 154206
EAN: 3800972016064



L1: 250mm
D1: 25mm
D2: 18mm



POINT CHISEL SDS-MAX

[BG] Длето-шило SDS-max • [RO] Spit SDS-max • [SR] Špic SDS-max • [MK] Длето остро SDS-max • [RU] Долото пика SDS-max • [SL] Dleto konica SDS-max • [EL] βελόνη SDS-max • [HR] Šiljato dljeto • [FR] Le bit de pointe SDS-max • [IT] Scalpello di punta SDS-max • [ES] La pinta SDS-max • [PT] Pico SDS-max

Art. No. 154205
EAN: 3800972009028



L1: 600mm
D1: 18mm



FLAT CHISEL SDS-MAX

[BG] Длето-секач SDS-max • [RO] Dalta SDS-max • [SR] Sekač SDS-max • [MK] Длето SDS-max • [RU] Долото SDS-max • [SL] Dleto SDS-max • [EL] Καλέμι διαβάθμισης • [HR] Plosnato dljeto • [FR] SDS-max burin • [IT] Scalpello SDS-max • [ES] SDS-max čizilo • [PT] Formão SDS-max

Art. No. 154204
EAN: 3800972009011



L1: 600mm
D1: 25mm
D2: 18mm

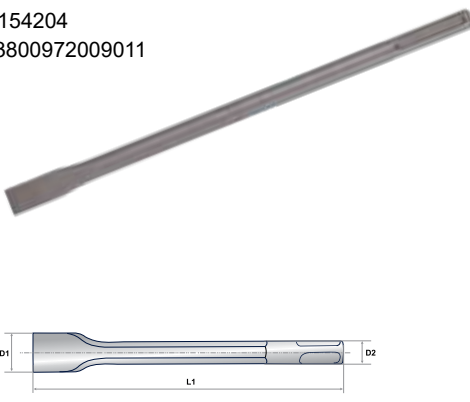

HAMMER DRILL BITS SDS-PLUS 5 PCS SET

[BG] Средна SDS-plus 5 бр. комплект • [RO] 5Pcs/Set burghie SDS-PLUS • [SR] Burgija za zid SDS-plus Set 5 kom • [MK] Бургија SDS-plus сет 5 ком • [RU] Сверло по бетону SDS-plus набор 5 шт • [SL] Sveder za beton SDS-plus nabor 5 kos • [EL] τρυπάνι για το σκυρόδεμα SDS-plus сет 5 τεμαχίων • [HR] Svrdla za zidove SDS-plus 5kom • [FR] Foret à béton SDS-plus • [IT] Punta per calcestruzzo SDS-plus • [ES] Drilo por concreto SDS-plus • [PT] Broca para betão SDS-plus

Ø 5-10mm

DRILLS 5 pcs:
Ø10, 12, 16, 19, 22, 25, 32mm

Art. No. 158101
EAN: 3800123125591



SDS+

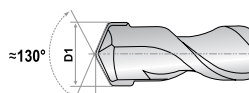

HAMMER DRILL BIT SDS-MAX

[BG] Свърдело SDS-max • [RO] Burghie beton SDS-max • [SR] Burgija za zid SDS-max • [MK] Буриџа за ѕид SDS-max • [RU] Свёрло по бетону SDS-max • [SL] Sveder za beton SDS-max • [EL] Τρυπάνι για το σκυρόδεμα SDS-max • [HR] Svrdlo za zidove SDS-max • [FR] Foret à béton SDS-max • [IT] Trapano per calcestruzzo SDS-max • [ES] SDS-max Konkretna Borilo • [PT] Broca de concreto SDS-max

| art. № | D1 (mm) | L1 (mm) | L2 (mm) | BARCODE |
|--------|---------|---------|---------|---------------|
| 153802 | Ø10 | 260 | 130 | 3800123125942 |
| 153803 | Ø12 | 260 | 130 | 3800123125959 |
| 153804 | Ø16 | 400 | 270 | 3800123125966 |
| 153805 | Ø20 | 400 | 270 | 3800123125973 |
| 153806 | Ø22 | 505 | 370 | 3800123125980 |
| 153807 | Ø25 | 600 | 470 | 3800123125997 |
| 153801 | Ø32 | 600 | 470 | 3800123145018 |
| 153808 | Ø12 | 400 | 290 | 3800972010468 |
| 153809 | Ø14 | 400 | 290 | 3800972010475 |
| 153810 | Ø16 | 600 | 490 | 3800972010482 |
| 153811 | Ø16 | 1000 | 890 | 3800972010499 |
| 153812 | Ø18 | 600 | 490 | 3800972010505 |
| 153813 | Ø18 | 1000 | 890 | 3800972010512 |
| 153814 | Ø20 | 600 | 490 | 3800972010529 |
| 153815 | Ø20 | 1000 | 890 | 3800972010536 |
| 153816 | Ø22 | 1000 | 890 | 3800972010543 |
| 153817 | Ø25 | 1000 | 890 | 3800972010550 |
| 153818 | Ø25 | 1000 | 490 | 3800972010567 |
| 153819 | Ø30 | 600 | 890 | 3800972010574 |
| 153820 | Ø35 | 1000 | 890 | 3800972010581 |

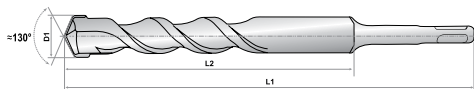

HAMMER DRILL BIT SDS-PLUS

[BG] Свърдело SDS-plus • [RO] Burghie beton SDS-plus • [SR] Burgija za zid SDS-plus • [MK] Буриџа SDS-plus • [RU] Свёрло по бетону SDS-plus • [SL] Sveder za beton SDS-plus • [EL] Τρυπάνι για το σκυρόδεμα SDS-plus • [HR] Svrdlo za zidove SDS-plus • [FR] Foret à béton SDS-max • [IT] Trapano per calcestruzzo SDS-max • [ES] SDS-max Konkretna Borilo • [PT] Broca de concreto SDS-max

| art. № | D1 (mm) | L1 (mm) | L2 (mm) | BARCODE |
|--------|---------|---------|---------|----------------|
| 159910 | 4 | 110 | 50 | 3800123150159 |
| 153630 | 5 | 110 | 50 | 3800123160165 |
| 153629 | 5 | 160 | 100 | 3800123160158 |
| 153634 | 5 | 210 | 150 | 3800123160219 |
| 153631 | 6 | 110 | 50 | 3800123160172 |
| 153601 | 6 | 160 | 100 | 3800123125447 |
| 153602 | 6 | 210 | 150 | 3800123125454 |
| 153632 | 8 | 110 | 50 | 3800123160189 |
| 153616 | 8 | 160 | 100 | 3800123160028 |
| 153603 | 8 | 210 | 150 | 3800123125478 |
| 153604 | 8 | 260 | 200 | 3800123125461 |
| 153617 | 8 | 350 | 300 | 3800123160035 |
| 153652 | 8 | 450 | 400 | 38001231600615 |
| 153633 | 10 | 110 | 50 | 3800123160196 |
| 153605 | 10 | 160 | 100 | 3800123125485 |
| 153606 | 10 | 210 | 150 | 3800123125492 |
| 153618 | 10 | 260 | 200 | 3800123160042 |
| 153607 | 10 | 310 | 250 | 3800123125508 |
| 153619 | 10 | 350 | 300 | 3800123160059 |
| 153620 | 10 | 460 | 400 | 3800123160066 |
| 153621 | 12 | 160 | 100 | 3800123160073 |
| 153608 | 12 | 210 | 150 | 3800123125515 |
| 153609 | 12 | 310 | 250 | 3800123125522 |
| 153622 | 12 | 350 | 300 | 3800123160080 |
| 153623 | 12 | 450 | 400 | 3800123160097 |
| 153624 | 14 | 160 | 100 | 3800123160103 |
| 153635 | 14 | 210 | 150 | 3800123160226 |
| 153636 | 14 | 260 | 200 | 3800123160233 |
| 153653 | 14 | 310 | 250 | 3800123160622 |
| 153625 | 14 | 350 | 300 | 3800123160110 |
| 153610 | 14 | 450 | 400 | 3800123125539 |
| 153638 | 16 | 160 | 100 | 3800123160257 |
| 153639 | 16 | 210 | 150 | 3800123160264 |
| 153651 | 16 | 300 | 250 | 3800123160608 |
| 153626 | 16 | 350 | 300 | 3800123160127 |
| 153611 | 16 | 450 | 400 | 3800123125546 |
| 153640 | 18 | 210 | 150 | 3800123160271 |
| 153627 | 18 | 350 | 300 | 3800123160134 |
| 153612 | 18 | 450 | 400 | 3800123125553 |
| 153628 | 20 | 350 | 300 | 3800123160141 |
| 153613 | 20 | 450 | 400 | 3800123125560 |
| 153614 | 22 | 450 | 400 | 3800123125577 |
| 153646 | 24 | 450 | 400 | 3800123160332 |
| 153615 | 26 | 450 | 400 | 3800123125584 |
| 153647 | 28 | 450 | 400 | 3800123160349 |
| 153648 | 30 | 450 | 400 | 3800123160356 |
| 153649 | 32 | 450 | 400 | 3800123160363 |
| 153682 | 14 | 1000 | 950 | 3800972010598 |
| 153683 | 18 | 1000 | 950 | 3800972010604 |
| 153684 | 22 | 1000 | 950 | 3800972010611 |
| 153685 | 30 | 1000 | 950 | 3800972010628 |
| 153686 | 32 | 1000 | 950 | 3800972010635 |

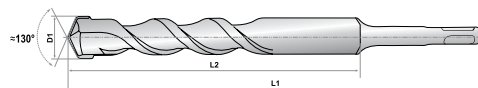

HAMMER DRILL BIT CROSS HEAD SDS-PLUS

[BG] Свърдело Cross Head SDS-plus • [RO] Burghie beton Cross Head SDS-plus • [SR] Burgija za zid Cross Head SDS-plus • [MK] Буриџа Cross Head SDS-plus • [RU] Свёрло по бетону Cross Head SDS-plus • [SL] Sveder za beton SDS-plus • [EL] Τρυπάνι για το σκυρόδεμα SDS-plus • [HR] Svrdlo za zidove SDS-plus 4-Plus • [FR] Foret à béton Cross Head SDS-plus • [IT] Trapano per calcestruzzo Cross Head SDS-plus • [ES] Cross Head SDS-plus Konkretna Borilo • [PT] Broca de concreto Cross Head SDS-plus

| art. № | D1 (mm) | L1 (mm) | L2 (mm) | BARCODE |
|--------|---------|---------|---------|---------------|
| 153656 | 6 | 110 | 50 | 3800123151255 |
| 153657 | 6 | 160 | 100 | 3800123151262 |
| 153658 | 6 | 210 | 150 | 3800123151279 |
| 153659 | 6.5 | 260 | 200 | 3800123151286 |
| 153660 | 8 | 110 | 50 | 3800123151293 |
| 153661 | 8 | 160 | 100 | 3800123151309 |
| 153662 | 8 | 210 | 150 | 3800123151316 |
| 153663 | 8 | 260 | 200 | 3800123151323 |
| 153664 | 8 | 350 | 300 | 3800123151330 |
| 153665 | 10 | 160 | 100 | 3800123151347 |
| 153666 | 10 | 210 | 150 | 3800123151354 |
| 153667 | 10 | 260 | 200 | 3800123151361 |
| 153668 | 10 | 350 | 300 | 3800123151378 |
| 153669 | 10 | 450 | 400 | 3800123151385 |
| 153670 | 12 | 210 | 150 | 3800123151392 |
| 153671 | 12 | 350 | 300 | 3800123151408 |
| 153672 | 12 | 450 | 400 | 3800123151415 |
| 153673 | 14 | 160 | 100 | 3800123151422 |
| 153674 | 14 | 210 | 150 | 3800123151439 |
| 153675 | 14 | 260 | 200 | 3800123151446 |
| 153676 | 14 | 350 | 300 | 3800123151453 |
| 153677 | 14 | 450 | 400 | 3800123151460 |
| 153678 | 16 | 260 | 210 | 3800972003156 |
| 153679 | 18 | 260 | 210 | 3800972003163 |
| 153680 | 20 | 260 | 210 | 3800972003170 |
| 153681 | 24 | 260 | 210 | 3800972003187 |

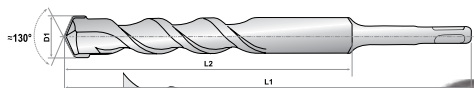

SHEET METAL HOLESAW WITH PILOT HSS DRILL BIT

[BG] Боркорона за ламарина с водач HSS • [RO] Freza gaurire HSS • [SR] Krunska glava za bušenje HSS • [MK] Круна за лим са бургија HSS • [RU] Биметаллическая коронка резки листового металла HSS • [SL] Kronska žaga za pločevina HSS • [EL] Κορώνα για την κοπή λαμαρίνας • [HR] Kruna za lim s vodič HSS • [FR] Tôle de coupe de couronne bimétallique HSS • [IT] Lamiera di metallo a corona bimetallica HSS • [ES] Bimetala krono tranča metalo HSS • [PT] Chapa de corte bimetalica HSS

| art. № | Ø / mm | BARCODE |
|--------|--------|---------------|
| 154801 | 25 | 3800123160424 |
| 154802 | 35 | 3800123160431 |



ADJUSTABLE HOLE CUTTER UP TO Ø120MM FOR WOOD

[BG] Боркорона за дърво до Ø120mm • [RO] Freza lemn reglabila-pana la 120mm • [SR] Krunska glava za bušenje • [MK] Круна за дрво • [RU] Набор коронка для древо • [SL] Kronska žaga za les • [EL] Κορώνα για την κοπή ξύλο • [HR] Kruna za drvo • [FR] Couronne sertie de bois • [IT] Corona per legno • [ES] Krono starigita por ligno • [PT] Coroa para madeira

Art. No. 157703
EAN: 3800123121579



HOLESAW Ø54MM AND DRILL BIT Ø22MM KIT

[BG] Боркорона Ø54mm и сверло Ø22mm за дърво к-т • [RO] Set carota 54mm si burghiu pentru lemn 22mm • [SR] Krunska glava za bušenje i burgija za drvo set • [MK] Круна и Бургија за дрво сет • [RU] Биметаллическая коронка и Сверло для древо набор • [SL] Kronska žaga za les in sveder nastav • [EL] Κορώνα για την κοπή ξύλο & Τρυπάνι Σετ • [HR] Kruna i Svrdo za drvo • [FR] Couronne bimétallique et foret pour jeu de bois • [IT] Corona bimetallica e punta per legno • [ES] Bimetala krono kaj taladro bito por ligno aro • [PT] Coroa bimetalica e broca para madeira

Ø54mm

Ø22mm

Art. No. 157701

EAN: 3800123121180



HOLE CUTTERS Ø19-127MM 16 PCS KIT FOR WOOD

[BG] Боркорони 16 части комплект • [RO] 16Pcs/Set Freza gaurire • [SR] Krunska glava za bušenje na drvo 16kom • [MK] Круна за дрво 16ком • [RU] Набор Коронка для древо 16 шт • [SL] Kronska žaga za les 16 kos • [EL] Κορώνα για την κοπή ξύλο 16 τεμ • [HR] 16-djelni set Krunske pile • [FR] Set Crown pour l'arbre • [IT] Imposta la corona per l'albero • [ES] Fiksu Kronon por la arbo • [PT] Definir coroa para a árvore

Ø 19-127mm

HOLE CUTTERS:
Ø19, 22, 29, 32, 38, 44, 51, 64,
76, 89, 102, 127 mm

Art. No. 157710

EAN: 3800123126000



HOLE CUTTERS Ø19-64MM 11 PCS KIT FOR WOOD

[BG] Боркорони 11 части комплект • [RO] 11Pcs/Set Freza gaurire • [SR] Krunska glava za bušenje na drvo 11 kom • [MK] Круна за дрво 11ком • [RU] Набор Коронка для древо 11 шт • [SL] Kronska žaga za les 11 kos • [EL] Κορώνα για την κοπή ξύλο 11 τεμ • [HR] 11-djelni set Krunske pile • [FR] Set Crown pour l'arbre • [IT] Imposta la corona per l'albero • [ES] Fiksu Kronon por la arbo • [PT] Definir coroa para a árvore

Ø 19-64mm

HOLE CUTTERS: Ø19, 22, 29, 32, 38, 44, 51, 64 mm

HOLESAWS:

Ø33, 53, 67, 73, 83mm

Art. No. 157707

EAN: 3800123121203



HOLE CUTTERS Ø26-63MM 7 PCS KIT FOR WOOD

[BG] Боркорони 7 части комплект • [RO] 7Pcs/Set Freza gaurire • [SR] Krunska glava za bušenje na drvo 7 kom • [MK] Круна за дрво 7 ком • [RU] Набор Коронка для древо 7 шт • [SL] Kronska žaga za les 7 kos • [EL] Κορώνα για την κοπή ξύλο 7 τεμ • [HR] 7-djelni set Krunske pile • [FR] Set Crown pour l'arbre • [IT] Imposta la corona per l'albero • [ES] Fiksu Kronon por la arbo • [PT] Definir coroa para a árvore

Ø 26-63mm 2"

HOLE CUTTERS:

Ø26, 32, 38, 45, 50, 56, 63 mm

Art. No. 157704

EAN: 3800123121197



BI-METAL HOLESAWS Ø22-64MM 9PCS KIT

[BG] Боркорони биметални 9 части комплект • [RO] 9Pcs/Set freze gaurire • [SR] Krunska glava za bušenje set 9kom • [MK] Круна за дрво 9ком • [RU] Набор Биметаллическая Коронка 9 шт • [SL] Kronska žaga 9 kos • [EL] Κορώνα για την κοπή ξύλο 9 τεμ • [HR] 9-djelni set Krunske pile Bi-Metal • [FR] Ensemble de couronne bimétallique • [IT] Set corona bimetallica • [ES] Bimetala Krono • [PT] Conjunto de coroa bimetalica

Ø 22-64mm

HOLESAWS:

Ø22, 35, 38, 44, 51, 64 mm

Art. No. 157712

EAN: 3800123160011



ADJUSTABLE HOLE CUTTER UP TO Ø90MM FOR TILES

[BG] Сверло за плочки • [RO] Dispozitive taiere circulara reglabil pana la 90mm • [SR] Burgija za bušenje na pločice • [MK] Бургија за плочки • [RU] Сверло для плитки • [SL] Sveder za keramične ploščice • [EL] Τρυπάνι για την κοπή κεραμικά πλακίδια • [HR] Svrdo za pločice • [FR] Perceuse • [IT] Trapano per piastrelle • [ES] Tile taladro • [PT] Broca de telha

Ø 0-90mm

Art. No. 159908

EAN: 3800123116490

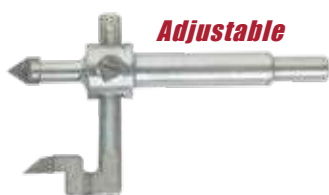

HOLESAW ARBOR WITH PILOT MASONRY DRILL BIT

[BG] Водач за би-метални боркорони с центриращо сверло • [RO] Burghiu de centrare cu zencuitor • [SR] Vodilica za krna sa burgija za centriranje • [MK] Водач за круна со центрирање вежба малку • [RU] Бур за Колоноквая бур фреза • [SL] Vodič za krona + sveder za centriranje • [EL] Οδηγός τρυπάνι • [HR] Adapter sa centrir svrdlom za krune • [FR] Fraise pour perceuse Kolonkovaya • [IT] Guida di perforazione • [ES] Borado Gvidilo • [PT] Guia de perfuração

5/8" (16 mm) for Bi-Metal Holesaws Ø32-200mm

Art. No. 157757

EAN: 3800123169199



HSS BI-METAL HOLESAW

[BG] Боркорона HSS bi-metal • [RO] Freze gaurire HSS bi-metal • [SR] Krunska glava za bušenje HSS bi-metal • [MK] Круна за дрво HSS bi-metal • [RU] Биметаллическая Коронка HSS bi-metal • [SL] Kronska žaga HSS bi-metal • [EL] Κορώνα για την κοπή ξύλου HSS bi-metal • [HR] Krunska svrdla HSS bi-metal • [FR] Couronne bimétallique HSS bi-métal • [IT] Bimetallic Crown HSS bi-metal • [ES] Bimetala Krono HSS bi-metal • [PT] Bimetálico Crown HSS bimetalico

| art. № | Ø (mm) | BARCODE |
|--------|--------|---------------|
| 157746 | Ø20 | 3800123169083 |
| 157786 | Ø22 | 3800123169496 |
| 157747 | Ø25 | 3800123169090 |
| 157787 | Ø30 | 3800123169502 |
| 157748 | Ø32 | 3800123169106 |
| 157749 | Ø35 | 3800123169113 |
| 157788 | Ø40 | 3800123169519 |
| 157750 | Ø44 | 3800123169120 |
| 157751 | Ø51 | 3800123169137 |
| 157752 | Ø57 | 3800123169144 |
| 157753 | Ø65 | 3800123169151 |
| 157754 | Ø68 | 3800123169168 |
| 157755 | Ø76 | 3800123169175 |
| 157756 | Ø83 | 3800123169182 |

Ø 20-83mm



HSS BI-METAL HOLESAW 8% CO

[BG] Боркорона HSS bi-metal 8% Co • [RO] Freze gaurire HSS bi-metal 8% Co • [SR] Krunska glava za bušenje HSS bi-metal 8% Co • [MK] Круна за дрво HSS bi-metal 8% Co • [RU] Биметаллическая Коронка HSS bi-metal 8% Co • [SL] Kronska žaga HSS bi-metal 8% Co • [EL] Κορώνα για την κοπή ξύλου HSS bi-metal 8% Co • [HR] Krunska svrdla HSS bi-metal 8% Co • [FR] Couronne bimétallique HSS bi-métal 8% Co • [IT] Corona bimetallica HSS bi-metallo 8% Co • [ES] Bimetala Krono HSS bi-metallo 8% Co • [PT] Coroa bimetalica HSS bimetalica 8% Co

Ø 20-83mm

| art. № | Ø (mm) | BARCODE |
|--------|--------|---------------|
| 157820 | Ø20 | 3800123173080 |
| 157821 | Ø22 | 3800123173097 |
| 157822 | Ø25 | 3800123173103 |
| 157823 | Ø30 | 3800123173110 |
| 157824 | Ø32 | 3800123173127 |
| 157825 | Ø35 | 3800123173134 |
| 157826 | Ø40 | 3800123173141 |
| 157827 | Ø44 | 3800123173158 |
| 157828 | Ø51 | 3800123173165 |
| 157829 | Ø57 | 3800123173172 |
| 157830 | Ø65 | 3800123173189 |
| 157831 | Ø67 | 3800123173196 |
| 157832 | Ø76 | 3800123173219 |
| 157833 | Ø83 | 3800123173226 |



CARBIDE HOLESAW ARBOR

[BG] Водач за Carbide боркорони • [RO] Arbore pentru carote Carbide • [SR] Vodičica za kruna Carbide • [MK] Водач за круна Carbide • [RU] Центрирующий бур для буровые коронки • [SL] Vodič za kruna Carbide • [EL] Ποτηροτρίπανο ξύλου • [HR] Adapter za kruna Carbide • [FR] Déchiqueteuse de bois • [IT] Cippatrice • [ES] Cifona ligno • [PT] Triturador de madeira

Ø 33-103mm

Art. No. 157762
EAN: 3800123169243



CARBIDE



CARBIDE



HOLESAW FOR CERAMICS Ø33-83MM 7PCS KIT

[BG] Боркорони за керамични плочки 7 части комплект • [RO] Set carote pentru placi ceramice • [SR] Krunska glava za bušenje na pločice 7 kom • [MK] Круна за плочки 7 ком • [RU] Набор Коронка для плитки 7 шт • [SL] Kronska žaga za keramične ploščice 7 kos • [EL] Κορώνα για την κοπή κεραμικά πλακίδια 7 τεμ • [HR] 7-djelni set Krunske pile za keramičke pločice • [FR] Set Crown pour tuiles • [IT] Imposta la corona per le tessere • [ES] Fiksita Krono por kaheljo • [PT] Definir coroa para telhas

Ø 33-83mm CARBIDE

HOLESAWS: Ø22, 35, 38, 44, 51, 64 mm

Art. No. 157714

EAN: 3800123115783



PILOT MASONRY DRILL BIT

[BG] Центриращо свредло за водач за bi-метални боркорони • [RO] Burghiu de centrare • [SR] Burgija za centriranje • [MK] Центрирање вежба • [RU] Центрирующее Сверло • [SL] Sveder za centriranje • [EL] Ποτηροτρίπανο ξύλου • [HR] Centrir svrdlom za kruna • [FR] Foret de centrage • [IT] Centratore Drill • [ES] Centri Drill • [PT] Broca de Centralização

Art. No. 157804

EAN: 3800123173660



COBALT PILOT DRILL BIT FOR BI-METAL HOLESAWS

[BG] Центриращо свредло Co за водач за bi-метални боркорони • [RO] Burghiu de centrare Co • [SR] Burgija za centriranje Co • [MK] Центрирање вежба Co • [RU] Центрирующее Сверло Co • [SL] Sveder za centriranje Co • [EL] Ποτηροτρίπανο ξύλου Co • [HR] Centrir svrdlom Co za kruna • [FR] Foret de centrage • [IT] Centratore Drill • [ES] Centri Drill • [PT] Broca de Centralização

Art. No. 157837

EAN: 3800972002043



TUNGSTEN CARBIDE TIPPED HOLE SAW

[BG] Боркорона Carbide • [RO] Freze gaurire Carbide • [SR] Krunska glava za bušenje Carbide • [MK] Круна за дрво Carbide • [RU] Коронка Carbide • [SL] Kronska žaga Carbide • [EL] Κορώνα για την κοπή Carbide • [HR] Krunska svrdla Carbide • [FR] Couronne pour couper le carbure • [IT] Corona per taglio di carburo • [ES] Krono por trançado Carbide • [PT] Coroa para corte de carboneto

| art. № | Ø (mm) | BARCODE |
|--------|--------|---------------|
| 157758 | Ø33 | 3800123169205 |
| 157759 | Ø43 | 3800123169212 |
| 157770 | Ø53 | 3800123169335 |
| 157760 | Ø67 | 3800123169229 |
| 157771 | Ø73 | 3800123169342 |
| 157772 | Ø83 | 3800123169359 |
| 157773 | Ø103 | 3800123169366 |



Ø 33-103mm

CARBIDE



PILOT MASONRY DRILL BIT

[BG] Центриращо свредло за водач за Carbide боркорони • [RO] Burghiu de centrare • [SR] Burgija za centriranje • [MK] Центрирање вежба • [RU] Центрирующее Сверло • [SL] Sveder za centriranje • [EL] Ποτηροτρίπανο ξύλου • [HR] Centrir svrdlom za kruna • [FR] Foret de centrage • [IT] Centratore Drill • [ES] Centri Drill • [PT] Broca de Centralização

Art. No. 157803

EAN: 3800123173479



CARBIDE



DIAMOND COATED HOLE SAW

[BG] Боркорона Diamond • [RO] Freze gaurire Diamond • [SR] Krunska glava za bušenje Diamond • [MK] Круна за дрво Diamond • [RU] Коронка Diamond • [SL] Kronska žaga Diamond • [EL] Κορώνα για την κοπή Diamond • [HR] Dijamantna krunska svrdla • [FR] Borkorona Diamond • [IT] Borkorona Diamond • [ES] Borkorona Diamond • [PT] Borkorona Diamond

Ø 6-76mm

| art. № | Ø mm | BARCODE |
|--------|--------------|---------------|
| 157774 | Ø6 | 3800123169373 |
| 157775 | Ø8 | 3800123169380 |
| 157776 | Ø10 | 3800123169397 |
| 157777 | Ø12 | 3800123169403 |
| 157778 | Ø25 (1") | 3800123169410 |
| 157779 | Ø30 (1 1/8") | 3800123169427 |
| 157780 | Ø35 (1 3/8") | 3800123169434 |
| 157781 | Ø44 (1 3/4") | 3800123169441 |
| 157782 | Ø51 (2") | 3800123169458 |
| 157783 | Ø68 | 3800123169465 |
| 157784 | Ø76 (3") | 3800123169472 |

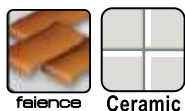

DRILL GUIDE HOLDER FOR DIAMOND COATED HOLE SAWS

[BG] Водач за диамантни боркорони • [RO] Ghid pentru carote diamantate • [SR] Vodič za dijaminske krune za bušenje • [MK] Водич за дијамантски боркорони • [RU] Руководство по алмазным коронкам • [SL] Vodnik za diamantne vrtnalnice • [EL] Οδηγός για ποτηροκωρώνες με διαμάντι • [HR] Vodič za dijamantrim bušaćim krunama • [FR] Guide pour les fraises diamantées • [IT] Guida per corone diamantate • [ES] Guía para los cortadores de base del diamante • [PT] Guia para cortadores de núcleo do diamante

Ø 4-83mm

Art. No. 157711

EAN: 3800972002401



DIAMOND DRY HOLE SAW

[BG] Боркорона Diamond Dry • [RO] Carote diamantate pentru gaurire uscata • [SR] Krunska glava za bušenje diamond Dry • [MK] Круна за дрво Diamond Dry • [RU] Коронка Diamond Dry • [SL] Kronska žaga Diamond Dry • [EL] Κορώνα για την κοπή Diamond Dry • [HR] Dijamantna krunska svrdla Dry • [FR] Borkorona Diamond Dry • [IT] Borkorona Diamond Dry • [ES] Borkorona Diamond Dry • [PT] Borkorona Diamond Dry

Ø 6-65mm
M14
FOR ANGLE GRINDER

| art. № | Ø mm | BARCODE |
|--------|------|---------------|
| 157838 | Ø6 | 3800972014794 |
| 157839 | Ø8 | 3800972014800 |
| 157840 | Ø10 | 3800972014817 |
| 157841 | Ø12 | 3800972014824 |
| 157842 | Ø18 | 3800972014831 |
| 157843 | Ø20 | 3800972014848 |
| 157844 | Ø22 | 3800972014855 |
| 157845 | Ø25 | 3800972014862 |
| 157846 | Ø30 | 3800972014879 |
| 157847 | Ø35 | 3800972014886 |
| 157848 | Ø40 | 3800972014893 |
| 157849 | Ø50 | 3800972014909 |
| 157850 | Ø65 | 3800972014916 |

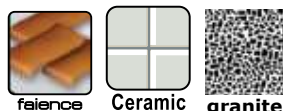

NEW
PRODUCT



HINGE HOLE CUTTER

[BG] Фрезер за отвор • [RO] Freza ptr balamale • [SR] Glodalo • [MK] Глодал • [RU] Зенкер для пробок • [SL] Režkar za luknjo • [EL] Φρεζών • [HR] Glodalo za utore, bočna • [FR] Charnière trou cutter • [IT] Cerniera per cerniere • [ES] Hinge Hole Cutter • [PT] Cortador De Furo De Dobradiça

| art. № | D1 (mm) | BARCODE |
|--------|---------|---------------|
| 154601 | Ø15 | 3800123121258 |
| 154602 | Ø20 | 3800123121265 |
| 154603 | Ø25 | 3800123121272 |
| 154604 | Ø30 | 3800123121289 |
| 154605 | Ø35 | 3800123121296 |
| 154606 | Ø40 | 3800123121302 |



HINGE CUTTING BITS TUNGSTEN CARBIDE TIPPED 5 PCS SET

[BG] Фрезери за отвори с твърдосплавни пластини Ø15,20,25,30 и 35mm 5бр. к-т • [RO] 5 Pcs/Set freze ptr balamale • [SR] Glodala set 5 kom • [MK] Глодалки сет 5 ком • [RU] Зенкеры для пробок набор 5 шт • [SL] Režkar za luknjo 5 kos • [EL] Σετ φρεζών 5 τεμ • [HR] 5-djelni set glodala • [FR] Charnière trou cutter • [IT] Cerniera per cerniere • [ES] Hinge Hole Cutter • [PT] Cortador De Furo De Dobradiça

Ø 15-35mm
CUTTERS D1: Ø15, 20, 25, 30, 35mm

Art. No. 157502

EAN: 3800123121210



ROUTER BIT

[BG] Фрезер за обертфреза • [RO] Freza profilata • [SR] Glodaló • [MK] Глодало • [RU] Зенкер • [SL] Režkar • [EL] Φρεζών • [HR] Glodaló za utore, bočna / ravna
 • [FR] Peu de routeur • [IT] Bit del router • [ES] Router Bito • [PT] Bit Router

| art. № | D2 Ø mm | D1/mm | H/mm | BARCODE |
|--------|---------|-------|------|---------------|
| 154405 | Ø 9.5 | Ø 8 | 38 | 3800123169700 |
| 154402 | Ø 12.7 | Ø 8 | 25 | 3800123121531 |
| 154406 | Ø 12.7 | Ø 8 | 50.8 | 3800123169717 |

WOOD

| art. № | D2 Ø mm | D1/mm | H/mm | BARCODE |
|--------|---------|-------|------|---------------|
| 154401 | Ø 15.9 | Ø 8 | 20 | 3800123121548 |

WOOD

| art. № | D2 Ø mm | D1/mm | H/mm | BARCODE |
|--------|---------|-------|------|---------------|
| 154409 | Ø 31.75 | Ø 8 | 6.35 | 3800123169748 |

WOOD

| art. № | D2 Ø mm | D1/mm | R/mm | B/mm | H/mm | BARCODE |
|--------|---------|-------|------|------|------|---------------|
| 154407 | Ø 17.46 | Ø 8 | 2.38 | 2.38 | 6.5 | 3800123169724 |

WOOD

| art. № | D2 Ø mm | D1/mm | R/mm | B/mm | H/mm | BARCODE |
|--------|---------|-------|------|------|------|---------------|
| 154404 | Ø 25.7 | Ø 8 | 6.35 | 6.35 | 9.52 | 3800123121524 |

WOOD

HANGER

| art. № | Ø mm | D1/mm | D2/mm | R/mm | B/mm | H/mm | BARCODE |
|--------|--------|-------|-------|------|------|------|---------------|
| 154408 | Ø 31.7 | Ø 8 | 31.7 | 9.52 | 9.52 | 15.9 | 3800123169731 |

WOOD

HANGER

ROUTER BIT

[BG] Фрезер за обертфреза • [RO] Freza profilata • [SR] Glodalno • [MK] Глодало • [RU] Зенкер • [SL] Rezkar • [EL] Φρεζων • [HR] Glodalno za utore, bočna / ravna • [FR] Peu de routeur • [IT] Bit del router • [ES] Router Bito • [PT] Bit Router

| art. № | D2 Ø mm | D1/mm | B/mm | BARCODE |
|--------|---------|-------|------|---------------|
| 154403 | Ø 30.96 | 8 | 12.7 | 3800123121555 |

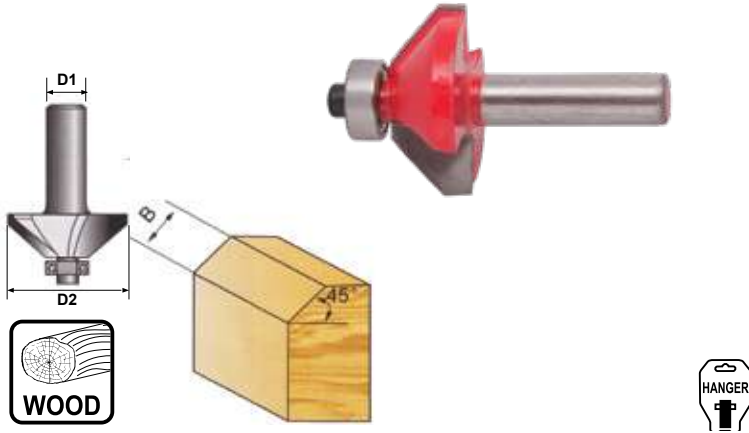

| art. № | D1 Ø mm | BARCODE |
|--------|---------|---------------|
| 158301 | Ø 8 | 3800123121500 |



| art. № | Ø D1/mm | BARCODE |
|--------|---------|---------------|
| 158302 | 8 | 3800123121517 |



| art. № | Ø D1/mm | BARCODE |
|--------|---------|---------------|
| 158303 | 8 | 3800123121630 |



| art. № | Ø D1/mm | BARCODE |
|--------|---------|---------------|
| 158304 | 8 | 3800123121241 |



| art. № | Ø D1/mm | BARCODE |
|--------|---------|---------------|
| 158305 | 8 | 3800123121678 |



JIGSAW BLADE CARBIDE "T" SHANK

[BG] Нож За Прободен Трион Carbide "T" • [RO] Rezerve Ferestaru Pendular - Carbide "T" • [SR] List Testere Za Ubodna Testera Carbide "T" • [MK] Нож За Убодна Пила Carbide "T" • [RU] Пильное Полотно Для Сабельных Пил Carbide "T" • [SL] Žagin List Carbide "T" • [EL] Приονόλαμες σέγας Carbide "T" • [HR] Listovi pile za metal Carbide "T" • [FR] Ensemble Carbide "T" [IT] Seghetto Carbide "T" • [ES] Vidita Carbide "T" • [PT] Lâmina Carbide "T"

| art. № | mm | L1/mm | L2/mm | pcs | BARCODE |
|-------------------|-----|-------|-------|-----|---------------|
| 155417 RD-CT141HM | 4.3 | 100 | 75 | 2 | 3800972009684 |

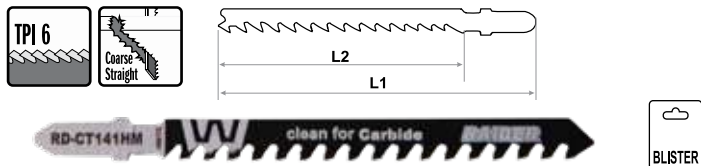

JIGSAW BLADE FOR METAL "T" SHANK

[BG] Нож За Прободен Трион За Метал "Т" 2 Бр. Комплект • [RO] Rezerve Ferestaru Pendular - 2Buc/Set • [SR] List Testere Za Ubodna Testera Set 2 Kom • [MK] Нож За Убодна Пила Set 2 Ком • [RU] Пильное Полотно Для Сабельных Пил Набор 2шт • [SL] Žagin List 2 kos • [EL] Приονόλαμες σέγας Set 2 τεμ • [HR] Listovi pile za metal • [FR] Ensemble de 2 lames de scie sauteuse pour tige en "T" en métal • [IT] Seghetto per seghe a sciabola Set di 2 pezzi • [ES] Vidita Klingo Por Sciata Saüco Aro de 2pcs • [PT] Lâmina de serra para sabre Serras Conjunto de 2pcs

| art. № | mm | L1/mm | L2/mm | pcs | BARCODE |
|------------------|-----|-------|-------|-----|---------------|
| 155411 RD-MT118G | 0.8 | 76 | 50 | 2 | 3800123164200 |
| 154412 RD-MT118A | 1.2 | 76 | 50 | 2 | 3800123164217 |

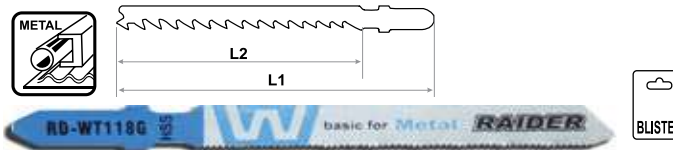

ASSORTED JIGSAW BLADES "T" SHANK SET

[BG] Нож За Прободен Трион за дърво & метал "Т" • [RO] Rezerve ferestaru pendular set • [SR] List testere za ubodna testera set • [MK] Нож за убодна пила сет • [RU] Пильное полотно для сабельных пил набор • [SL] žagin list • [EL] Приονόλαμες σέγας Set • [HR] Listovi pile • [FR] Lame de scie pour scie sabre sets • [IT] Lama per sega a sciabola set • [ES] Širita klingo por sabročambroj starigis 5 komputilojn • [PT] Lâmina de serra para serras de sabre com

| art. № | models | pcs | BARCODE |
|--------|---|-----|---------------|
| 155413 | T119BO, T144D, T101B, T111C, T118A | 5 | 3800123164224 |
| 154414 | T19BO 2pcs.; T144D 2pcs.; T101B2pcs.; T111C 2pcs., T118A 1pcs.; T118G 1pcs. | 10 | 3800123164231 |
| 155416 | T119BO 2pcs.; T144D 2pcs.; T101B 2pcs.; T123X 1pcs. T111C 2pcs., T118A 2pcs.; T118B 3pcs.; T101BR 2pcs. | 16 | 3800972009677 |



JIGSAW BLADES "T" SHANK 5 PCS. SET

[BG] Нож за прободен трион "Т" 5 бр. комплект • [RO] Rezerve ferestaru pendular-5buc/set • [SR] List testere za ubodna testera set 5 kom • [MK] Нож за убодна пила сет 5 ком • [RU] Пильное полотно для сабельных пил набор 5 шт [SL] žagin list 5 kos • [EL] Приονόλαμες σέγας Set 5 τεμ • [HR] Listovi pile za drvo 5 kom • [FR] Couteau à découper "T" 5 pcs. kit • [IT] Coltello da taglio "T" 5 pz. set • [ES] Trancilo trancilo "T" 5 PC. kit • [PT] Faca de corte "T" 5 pcs. kit

| art. № | tpi | pcs | BARCODE |
|-----------------|-----|-----|---------------|
| 209911 for wood | 8 | 5 | 3800123107269 |
| 209903for metal | 1.6 | 5 | 3800123123740 |

Art. No. 209911



Art. No. 209903



RECIPROCATING SAW BLADE FOR WOOD 10TPI HSS

[BG] Нож за саблевиден трион за дърво • [RO] Lama ferestrau sabie ptr lemn HSS • [SR] List testere za sabljasta testera za drvo • [MK] Нож за убодна пила за дрво • [RU] Пильное полотно для маятниковый лобзик • [SL] Žagin list za nihajna vbodna žaga • [EL] Приονόλαμες σέγας приони σεγα • [HR] Listovi pile za drvo za Recipročna pila • [FR] Soucoupe scie à bois • [IT] Seghe piatte per legno • [ES] Saucer vidis por ligno • [PT] Serra de discos para madeira

| art. № | length/mm | tpi | pcs | BARCODE |
|-------------------|--------------|-----|-----|---------------|
| 155502 RD-WS1531L | 240x19x1.5 | 10 | 2 | 3800123164248 |
| 155420 RD-WS644D | 150x1.25x4.3 | 2 | 2 | 3800972009714 |
| 155421 RD-WS1111K | 225x1.25x8.5 | 2 | 2 | 3800972009721 |



RECIPROCATING SAW BLADE FOR WOOD AND METAL 2 PCS.

[BG] Нож за саблевиден трион за дърво и метал • [RO] Lama ferestrau sabie ptr lemn HSS • [SR] List testere za sabljasta testera za drvo • [MK] Нож за убодна пила за дрво • [RU] Пильное полотно для маятниковый лобзик • [SL] Žagin list za nihajna vbodna žaga • [EL] Приονόλαμες σέγας приони σεγα • [HR] Listovi pile za drvo za Recipročna pila • [FR] Soucoupe scie à bois • [IT] Seghe piatte per legno • [ES] Saucer vidis por ligno • [PT] Serra de discos para madeira

| art. № | length/mm | tpi | pcs | BARCODE |
|--------|------------------|-----|-----|---------------|
| 155422 | 225x0.9(1.8-2.6) | 10 | 2 | 3800972009738 |



RECIPROCATING SAW BLADE FOR METAL

[BG] Нож за саблевиден трион за метал • [RO] Lama ferestrau sabie ptr metal HSS • [SR] List testere za sabljasta testera za metal • [MK] Нож за убодна пила за метал • [RU] Пильное полотно для маятниковый лобзик • [SL] Žagin list za nihajna vbodna žaga • [EL] Приονόλαμες σέγας приони σεγα • [HR] Listovi pile za metal za Recipročna pila • [FR] Lame de scie alternative pour métal • [IT] Seghetto alternativo per metallo • [ES] Reciprocating Saw Blade for Metal • [PT] Lâmina de Serra Reciprocante para Metal

| art. № | length/mm | tpi | pcs | BARCODE |
|--------|------------|-----|-----|---------------|
| 155503 | 225x19x0.9 | 24 | 2 | 3800123164255 |



JIGSAW BLADE FOR WOOD "T" SHANK 2 PCS SET



JIGSAW BLADE FOR WOOD "T" SHANK 2 PCS SET

[BG] Нож За Прободен Трион За Дърво "Т" 2 Бр. Комплект • [RO] Rezerve Ferestaru Pendular - 2Вuc/Set • [SR] List Testere Za Ubodna Testera Set 2 Kom • [MK] Нож За Убодна Пила Set 2 Ком • [RU] Пильное Полотно Для Сабельных Пил Набор 2шт [SL] Žagin List 2 kos • [EL] Приονόλαμες Σέγας Set 2 τεμ • [HR] Listovi pile za drvo • [FR] Lame de scie pour scie sabre, lot de 2 • [IT] Seghetto per seghe a sciabola Set di 2 pezzi • [ES] Vidita Klingo Por Scianta Saüco Aro de 2pcs • [PT] Lâmina de serra para sabre Serras Conjunto de 2pcs

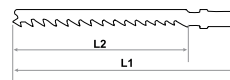

| art. № | step mm | L1/mm | L2/mm | pcs | BARCODE |
|--------------------|---------|-------|-------|-----|---------------|
| 155419** RD-WT744D | 4 | 180 | 155 | 2 | 3800972009707 |

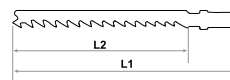

| art. № | step mm | L1/mm | L2/mm | pcs | BARCODE |
|-------------------|---------|-------|-------|-----|---------------|
| 155401 RD-WT1190B | 2 | 76 | 50 | 2 | 3800123164101 |

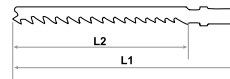

| art. № | step mm | L1/mm | L2/mm | pcs | BARCODE |
|------------------|---------|-------|-------|-----|---------------|
| 155402 RD-WT111C | 3 | 100 | 75 | 2 | 3800123164118 |

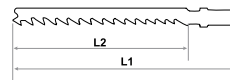

| art. № | step mm | L1/mm | L2/mm | pcs | BARCODE |
|------------------|---------|-------|-------|-----|---------------|
| 155403 RD-WT144D | 4 | 100 | 75 | 2 | 3800123164125 |

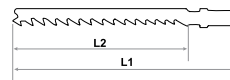

| art. № | step mm | L1/mm | L2/mm | pcs | BARCODE |
|-------------------|---------|-------|-------|-----|---------------|
| 155404 RD-WT244DS | 4 | 100 | 75 | 2 | 3800123164132 |





2 pcs
WOOD
L1 100mm
L2 75mm
4.0mm

fast
CUT

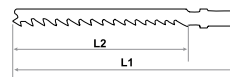

| art. № | step mm | L1/mm | L2/mm | pcs | BARCODE |
|------------------|---------|-------|-------|-----|---------------|
| 155405 RD-WT344D | 4 | 132 | 110 | 2 | 3800123164149 |



2 pcs
WOOD
L1 76mm
L2 50mm
1.4mm

| art. № | step mm | L1/mm | L2/mm | pcs | BARCODE |
|-------------------|---------|-------|-------|-----|---------------|
| 155406 RD-WT101AO | 1.4 | 76 | 50 | 2 | 3800123164156 |



2 pcs
WOOD
L1 76mm
L2 50mm
1.4mm

| art. № | step mm | L1/mm | L2/mm | pcs | BARCODE |
|-------------------|---------|-------|-------|-----|---------------|
| 155406 RD-WT101AO | 1.4 | 76 | 50 | 2 | 3800123164156 |



2 pcs
WOOD
L1 100mm
L2 75mm
2.5mm

| art. № | step mm | L1/mm | L2/mm | pcs | BARCODE |
|------------------|---------|-------|-------|-----|---------------|
| 155407 RD-WT101B | 2.5 | 100 | 75 | 2 | 3800123164163 |



2 pcs
WOOD
L1 100mm
L2 75mm
2.5mm

| art. № | step mm | L1/mm | L2/mm | pcs | BARCODE |
|-------------------|---------|-------|-------|-----|---------------|
| 155408 RD-WT101BR | 2.5 | 100 | 75 | 2 | 3800123164170 |



2 pcs
WOOD
L1 100mm
L2 75mm
4mm

| art. № | step mm | L1/mm | L2/mm | pcs | BARCODE |
|-------------------|---------|-------|-------|-----|---------------|
| 155409 RD-WT 101D | 4 | 100 | 75 | 2 | 3800123164187 |



2 pcs
WOOD
L1 116mm
L2 90mm
3mm

| art. № | step mm | L1/mm | L2/mm | pcs | BARCODE |
|-------------------|---------|-------|-------|-----|---------------|
| 155410 RD-WT301CD | 3 | 116 | 90 | 2 | 3800123164194 |



2 pcs
WOOD
L1 116mm
L2 90mm
3mm

fast
CUT

| art. № | step mm | L1/mm | L2/mm | pcs | BARCODE |
|--------------------|---------|-------|-------|-----|---------------|
| 155418* RD-WT344CB | 3 | 116 | 90 | 2 | 3800972009691 |



RECIPROCATING SAW BLADE FOR BRICKS RD-RS2243

[BG] Нож за саблвиден трион за тухли • [RO] Lama ferestrau sabie ptr cărămidă • [SR] List testere za sabljasta testera za oreke • [MK] Нож за уводна пила за тула • [RU] Пильное полотно для маятниковый лобзик • [SL] Žagin list za nihajna vbodna žaga • [EL] Приονόλαμες σέγας πριονο σέγα • [HR] Listovi pile za cigla za Recipročna pila • [FR] Lame de scie alternative pour briques • [IT] Seghetto alternativo per mattoni • [ES] Reciproca Sudo-klingo por Brikoj • [PT] Lâmina de Serra Reciprocante para Tijolos

| art. № | mm | L1/ mm | L2/ mm | pcs | BARCODE |
|--------|-------|-----------|-----------|-----|---------------|
| 155415 | 12..7 | 455 | 405 | 1 | 3800123173813 |

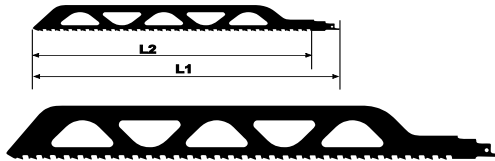

SAW BLADE FOR OSCILLATING MULTI-TOOL FOR METAL & WOOD

[BG] Нож за Многофункционален Инструмент за метал и дърво • [RO] Rezerve ptr Sculă Multifuncțională [SR] List Testere Za Višenamenski Alat [MK] Нож За Повеќенаменски Алат • [RU] Пильное Полотно Для Многофункциональный Инструмент • [SL] Žagin List za Večnamensko Orodje • [EL] μαχαίρι για Εργαλείο Πολλαπλής Χρής • [HR] Ravna oštrica • [FR] Lame de scie pour outil polyvalent oscillant pour métal et bois • [IT] Saw Blade for Oscillating Multi-Tool per metallo e legno • [ES] Saw Blade por Oscillating Multi-Tool por Metallo & Ligno • [PT] Lâmina de serra para multiferramenta oscilante para metal e madeira

32x40mm

Art. No. 155602
EAN: 3800123164514

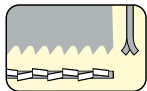

Milled and side set teeth

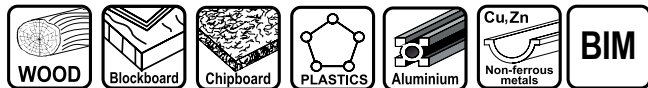

SAW BLADE FOR OSCILLATING MULTI-TOOL FOR WOOD

[BG] Нож за многофункционален инструмент за дърво • [RO] Rezerve ptr sculă multifuncțională • [SR] List testere za višenamenski alat • [MK] Нож за повеќенаменски алат • [RU] Пильное полотно для многофункциональный инструмент • [SL] Žagin list za večnamensko orodje • [EL] Μαχαίρι για εργαλείο πολλαπλής χρής • [HR] Ravna oštrica • [FR] Lame de scie pour outil polyvalent oscillant pour bois • [IT] Lama per sega per utensile oscillante per legno • [ES] Śirita klingon por oscillating multi-tool por wood • [PT] Lâmina de serra para multiferramenta oscilante para madeira

34x40mm

Art. No. 155601
EAN: 3800123164507



SAW BLADE FOR OSCILLATING MULTI-TOOL FOR WOOD

Ø87mm

Art. No. 155603
EAN: 3800123164521

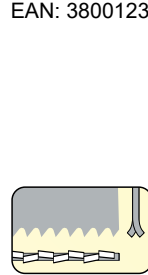

Milled and side set teeth



SAW BLADE FOR OSCILLATING MULTI-TOOL FOR METAL & WOOD

Ø87mm

Art. No. 155604
EAN: 3800123164538



BIM

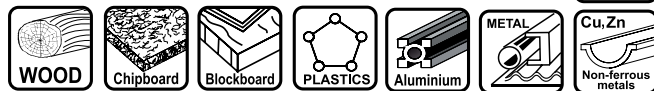

SCRAPER FOR OSCILLATING MULTI-TOOL

[BG] Шабер за многофункционален инструмент • [RO] Rezerve ptr sculă multifuncțională • [SR] Strugač za višenamenski alat • [MK] Стругало за повеќенаменски алат [RU] Скребок для многофункциональный инструмент [SL] Strgalo za večnamensko orodje • [EL] Ξύστρα για εργαλείο πολλαπλής χρής • [HR] Strugač [FR] Raclor pour outil polyvalent oscillant • [IT] Raschietto per multi attrezzo oscillante • [ES] Skrapilo por oscilla multi-ilo • [PT] Raspador para multiferramenta oscilante

52x45mm

Art. No. 155605
EAN: 3800123164545



SAW BLADE FOR OSCILLATING MULTI-TOOL CARBIDE

[BG] Нож за многофункционален инструмент за фуги Carbide • [RO] Rezerve ptr Sculă Multifuncțională Carbide • [SR] List Testere Za Višenamenski Alat Carbide • [MK] Нож За Повеќенаменски Алат • [RU] Пильное Полотно Для Многофункциональный Инструмент • [SL] Žagin List za Večnamensko Orodje Carbide • [EL] μαχαίρι για Εργαλείο Πολλαπλής Χρής Carbide • [HR] Okrugla oštrica • [FR] Lame de scie pour outil polyvalent oscillant • [IT] Lama per sega per attrezzo oscillante multi-utensile • [ES] Saw Blade por Oscilla Multi-ilo • [PT] Lâmina de serra para multi-ferramenta oscilante

Ø85mm

Art. No. 155606
EAN: 3800123164552

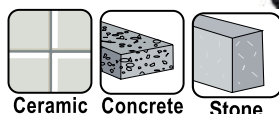

CARBIDE

SANDING PLATE FOR OSCILLATING MULTI-TOOL CARBIDE

[BG] Шлифовъчна плоча за многофункционален инструмент Carbide • [RO] Placă de Șlefuire ptr Sculă Multifuncțională Carbide • [SR] Brusna ploča Za Višenamenski Alat • [MK] Плоча за Брусене За Повеќенаменски Алат • [RU] Шлифпластина Для Многофункциональный Инструмент [SL] Brušenje Ploščo za Večnamensko Orodje Carbide • [EL] Πλάκα λείανσης για εργαλείο Πολλαπλής Χρής Carbide • [HR] Brusni disk • [FR] Plateau abrasif pour carbure multi-outils oscillant • [IT] Piastra di levigatura per carburo multi-utensile oscillante • [ES] Sanding Plate por Oscilla Multi-ilo • [PT] Placa de lixamento para multi-ferramenta oscilante

80mm

Art. No. 155607
EAN: 3800123164569

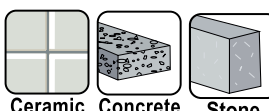

CARBIDE



SANDING PLATE FOR MULTI-TOOL VELCRO

[BG] Шлифовъчна плоча за многофункционален инструмент Velcro • [RO] Placă de Şlefuire ptr Sculă Multifuncţională Velcro [SR] Brusna ploča Za Višenamenski Alat • [MK] Плоча за Брусење За Повеќенаменски Алат • [RU] Шлифпластина Для Многофункциональный Инструмент • [SL] Brušenje Ploščo za Večnamensko Orodje Velcro • [EL] Πλάκα Λείανσης για Εργαλείο Πολλαπλής Χρής Velcro • [HR] Brusni disk • [FR] Plaque de ponçage pour velcro multi-outils • [IT] Piastra di levigatura per velcro oscillante multi-utensile • [ES] Sanding Plate por Multi-lla Velcro • [PT] Placa de lixamento para o velcro oscilante de várias ferramentas

93mm

Art. No. 155608
EAN: 3800123164576



ACCESSORIES FOR OSCILLATING MULTIFUNCTIONAL TOOL 10PCS. KIT

[BG] Аксесоари за многофункционален инструмент 10 бр. комплект • [RO] Set 10 buc banda smirghel Velcro pentru scula multifunctionala • [SR] Prnadležnosti 10 kom za višenamenski alat • [MK] Додатоци 10 ком за повеќенаменски алат • [RU] Аксессуары 10 шт. для многофункциональный инструмент • [SL] Dodatki 10 kos za večnamensko orodje • [EL] Αξσουάρ Σετ 10 Τεμ για Εργαλείο Πολλαπλής Χρής • [HR] Oscilacijski alat 10 kom • [FR] Accessoires pour outil multifonction oscillant 10 pcs. Trousse • [IT] Accessori per utensile multifunzione oscillante 10 pz. Kit • [ES] Akcesorajoj por Oscillating Multifunction Tool 10 komputiloj. Kit • [PT] Acessórios para ferramenta multifuncional oscilante 10 pcs.

Art. No. 155610
EAN: 3800123164613

155609 6pcs; 155608 1pc;
155605 1pc;
155604 1pc, Saw Blade 28 mm

10pcs

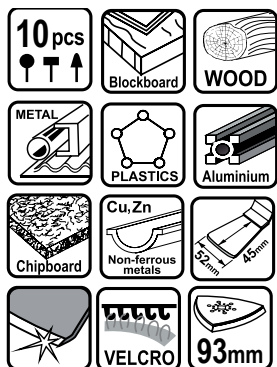

REVERSIBLE BLADES FOR PLANERS 82MM 2 PCS. SET FOR RD-EPO9, 10 & 11

[BG] Ножове за ренде ел. 2 бр. комплект • [RO] Set 2 buc Lame pentru rindea electrică • [SR] Set Noževa za Električna Hobarica 2 kom. • [MK] Нож за електрично ренде сет 2 бр • [RU] Нож за Электрический станок набор 2 шт • [SL] Electric planer nož kit 2 kosa • [EL] Ηλεκτρικό μηχάνημα μαχαίρι сет 2 τεμάχια • [HR] Nož blanje 2 kom • [FR] Lames réversibles pour raboteuses 82mm 2 pcs • [IT] Lame reversibili per piallatrici 82mm 2 pz • [ES] Reversibles Klingoj por planantoj 82mm 2 PC • [PT] Láminas reversíveis para plainas 82mm 2 peças

| art. № | length/mm | pcs | BARCODE |
|--------|-----------|-----|---------------|
| 209937 | 82 | 2 | 3800123104800 |



SCROLL SAW BLADE 2 PCS SET

[BG] Нож за машина за орнаменти 2 броя комплект • [RO] set 2 buc lama pentru fierastrau de banc • [SR] List testere za tračna testera 2 kom Set • [MK] Нож за машина за изразување на украси 2 парчиња • [RU] Пильное полотно для выделите пила 2 шт набор • [SL] Žagin list za električna rezbarska žaga 2 kosa • [EL] Πριονόλαμες σέγας για πριονοκορδέλες Σετ 2 τεμ • [HR] Nož za Stroj za rezanje ornamentima 2 kom • [FR] Jeu de 2 lames de scie à chantourner • [IT] Lama per sega a scorimento Set 2 pezzi • [ES] Blade por vidi 2 komputiloj. Kit • [PT] Lámina para serra 2 unidades

| art. № | length/mm | pcs | BARCODE |
|--------|-----------|-----|---------------|
| 209912 | 127 | 2 | 3800123107627 |



SANDING SHEETS FOR OSCILLATING MULTI-TOOL 10 PCS

[BG] Шкурка за многофункционален инструмент 10 бр. комплект Velcro • [RO] 10Psc/Set banda smirghel ptr Sculă Multifuncţională Velcro • [SR] Brusni papir 10 kom za Višenamenski Alat • [MK] Абразивна Хартија 10 ком за Повеќенаменски Алат • [RU] Бумага наждачная 10 шт. Для Многофункциональный Инструмент • [SL] Brusni platna 10 kos za Večnamensko Orodje Velcro • [EL] Γυαλόχαρτο Σετ 10 Τεμ για Εργαλείο Πολλαπλής Χρής Velcro • [HR] Brusni papir 10 kom • [FR] Lame de scie pour outil polyvalent oscillant • [IT] Lama per sega per attrezzo oscillante multi-utensile • [ES] Saw Blade por Oscilla Multi-Ilo • [PT] Lámina de serra para multi-ferramenta oscilante

GRIT: 60-240
93mm

Art. No. 155609
EAN: 3800123164583



KNIFE FOR PLANNER 2 PCS SET

[BG] Ножове за абрихт 2 броя комплект • [RO] Set 2 cutite pentru rindea electrica • [SR] Nož za rende 2 kom Set • [MK] Ножеви за абрихт 2 парчиња комплект • [RU] Нож строгальный 2 шт набор • [SL] Skobeljni noži 2 kosa • [EL] Μαχαίρια Πλάνη Σετ 2 τεμάχια • [HR] Nož blanje 2 kom • [FR] Couteau pour planificateur 2 pcs Set • [IT] Coltello per Planner Set 2 pezzi • [ES] Knife por Planisto 2 komputiloj • [PT] Faca para Planner 2 pcs Set

| art. № | length/mm | pcs | BARCODE |
|--------|-----------|-----|---------------|
| 155501 | 250 | 2 | 3800123162060 |
| 155504 | 305 | 2 | 3800123171215 |



BAND SAW BLADE FOR RD-BSW 18

[BG] Лента за банциг • [RO] Lama ptr ferestrau de banc • [SR] List testere za trakasta testera • [MK] Нож за трачна пила • [RU] Пильное полотно для ленточная пила • [SL] Žagin list za električna rezbarska žaga • [EL] Πριονόλαμες σέγας για πριονοκορδέλες • [HR] Listova pila za Tračna pila • [FR] Lame de scie • [IT] La lama della sega • [ES] Bendita Bando • [PT] Lámina de serra de fita

Art. No. 155701
EAN: 3800123162183

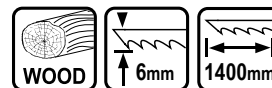

DIAMOND CUTTING DISC DRY

[BG] Диск диамантен DRY • [RO] Disc diamantat segmentat DRY • [SR] Rezna ploča dijamantska DRY • [MK] Дијамантски диск • [RU] Абразивный круг диаманта DRY • [SL] Diamantna rezalna plošča DRY • [EL] Κύκλοι κοπής διαμαντιών DRY • [HR] Dijamantne ploče DRY • [FR] Disque de coupe le diamant • [IT] Diamond Disco da taglio • [ES] Trancha disco • [PT] Diamond Disco de corte

| art. № | model | Ø (mm) | D1 (mm) | BARCODE |
|--------|-------|--------|-------------|---------------|
| 162122 | - | 85 | 10 | 3800123166143 |
| 162101 | DD01 | 115 | 22.2 (20) | 3800123126123 |
| 162104 | DD02 | 125 | 22.2 (20) | 3800123126390 |
| 162107 | DD03 | 180 | 22.2 (25.4) | 3800123126406 |
| 162110 | DD04 | 230 | 22.2 (25.4) | 3800123126482 |

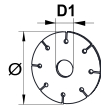

DIAMOND CUTTING DISC TURBO

[BG] Диск диамантен TURBO • [RO] Disc diamantat segmentat • [SR] Rezna ploča dijamantska TURBO • [MK] Дијамантски диск Т • [RU] Абразивный круг диаманта TURBO • [SL] Diamantna rezalna plošča TURBO • [EL] Κύκλοι κοπής διαμαντιών • [HR] Dijamantne ploče • [FR] Disque de coupe le diamant TURBO • [IT] Diamond Disco da taglio TURBO • [ES] Trancha disco • [PT] Diamond Disco de corte TURBO

| art. № | model | Ø (mm) | D1 (mm) | BARCODE |
|--------|-------|--------|-------------|---------------|
| 162102 | DD05 | 115 | 22.2 (20) | 3800123126444 |
| 162105 | DD06 | 125 | 22.2 (20) | 3800123126451 |
| 162108 | DD07 | 180 | 22.2 (25.4) | 3800123126468 |
| 162111 | DD08 | 230 | 22.2 (25.4) | 3800123126499 |

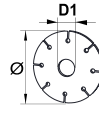

DIAMOND CUTTING DISC WET

[BG] Диск диамантен WET • [RO] Disc diamantat segmentat WET • [SR] Rezna ploča dijamantska WET • [MK] Дијамантски диск WET • [RU] Абразивный круг диаманта WET • [SL] Diamantna rezalna plošča WET • [EL] Κύκλοι κοπής διαμαντιών WET • [HR] Dijamantne ploče WET • [FR] Disque de coupe le diamant • [IT] Diamond Disco da taglio • [ES] Trancha disco • [PT] Diamond Disco de corte

| art. № | model | Ø (mm) | D1 (mm) | BARCODE |
|--------|-------|--------|-------------|---------------|
| 162121 | CS24 | 85 | 10 | 3800123166136 |
| 162123 | CS25 | 110 | 20 | 3800123167577 |
| 162103 | DD09 | 115 | 22.2 (20) | 3800123126413 |
| 162106 | DD10 | 125 | 22.2 (20) | 3800123126420 |
| 162109 | DD11 | 180 | 22.2 (25.4) | 3800123126437 |
| 162116 | DD16 | 200 | 22.2 (25.4) | 3800123127472 |
| 162112 | DD12 | 230 | 22.2 (25.4) | 3800123126611 |
| 162117 | DD17 | 300 | 25.4 | 3800123127489 |

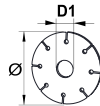
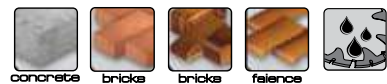

DIAMOND CUTTING DISC TURBO SUPER THIN

[BG] Диск диамантен TURBO ТЪНЪК • [RO] Disc diamantat segmentat SUBȚIRE • [SR] Rezna ploča dijamantska TURBO TUNUK • [MK] Дијамантски диск • [RU] Абразивный круг диаманта TURBO • [SL] Diamantna rezalna plošča TURBO • [EL] Κύκλοι κοπής διαμαντιών • [HR] Dijamantne ploče • [FR] Disque de coupe le diamant TURBO • [IT] Diamond Disco da taglio TURBO • [ES] Trancha disco • [PT] Diamond Disco de corte TURBO

| art. № | model | Ø (mm) | D1 (mm) | BARCODE |
|--------|-------|--------|-----------|---------------|
| 162201 | DD21 | 115 | 22.2 (20) | 3800972016415 |
| 162202 | DD22 | 125 | 22.2 (20) | 3800972016422 |

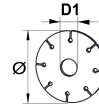

NEW PRODUCT

DIAMOND GRINDING HEAD

[BG] Диск диамантен за шлайфване на бетон • [RO] Disc oala ptr slefuit beton • [SR] Brusna ploča dijamantska • [MK] Дијамантски диск за брусьење на бетон • [RU] Абразивный круг диаманта • [SL] Diamantna brusna plošča • [EL] Κύκλος κοπής διαμαντιών профίλ για την πέτρα • [HR] Dijamantna brusna ploča • [FR] Tête de broyage le diamant • [IT] Testa di macinazione • [ES] Muelanta kapon • [PT] Diamond Disco cabeça de moagem

| art. № | Ø (mm) | D1 (mm) | BARCODE |
|--------|--------|-----------|---------------|
| 209931 | 125 | 22.2 (20) | 3800123150678 |
| 209932 | 180 | 22.2 | 3800123150685 |



HANDLE FOR ANGLE GRINDER

[BG] Дръжка за ъглошлайф • [RO] Măner pentru polizor unghiular • [SR] Ručka za ugao ni brusilicu • [MK] Рачка за меленење на агол • [RU] Угловая шлифовальная ручка • [SL] Kotni ročaj brusilnika • [EL] Λαβή για γωνιακό λειαντήρα • [HR] Ručka za kutni brusilicu • [FR] Poignée auxiliaire pour meuleuse d'angle • [IT] Maniglia per smerigliatrice angolare • [ES] Tenilo por angula muelillo • [PT] Pega para rebarbadora

Ø 115/125mm

Art. No. 139502
EAN: 3800972014923



PLASTIC DUST COLLECTOR FOR ANGLE GRINDER

[BG] Предпазител за прахоулавяне за ъглошлайф • [RO] Colector de praf din plastic pentru polizor unghiular • [SR] Plastični sakupljač prašine za ugao ni brusilicu • [MK] Пластичен колектор за прашина за мелница за агол • [RU] Пластиковый пылесборник для угловых шлифовальных машин • [SL] Plastični zbiralnik prahu za kotno brusilko • [EL] Πλαστικός συλλέκτης σκόνης για γωνιακό μύλο • [HR] Plastični sakupljač prašine za kutni brusilicu • [FR] Dépoussiéreur en plastique pour meuleuse d'angle • [IT] Depolverizzatore in plastica per smerigliatrice angolare • [ES] Plasta polvosucilo por angula muelillo • [PT] Coletor de pó de plástico para rebarbadora

| art. № | Ø (mm) | BARCODE |
|--------|--------|---------------|
| 139503 | 125 | 3800972015258 |



CUTTING DISC METAL

[BG] Диск за метал • [RO] Disc pentru taiat metal • [SR] Rezna ploča za metal • [MK] Диск за сечење на метал
 [RU] Отрезной диск для резки металла • [SL] Rezne plošče - kovina • [EL] Δίσκος κοπής μετάλλου • [HR] Ploča za rezanje metal
 za rezanje metal • [FR] Disque de coupe en métal • [IT] Disco da taglio in metallo • [ES] Trancanta Diskon Metalo • [PT] Metal de disco de corte

| art. № | Ø (mm) | D1 (mm) | D2 (mm) | BARCODE |
|--------|--------|---------|---------|---------------|
| 160150 | 85 | 10 | 1.0 | 3800123166129 |
| 160118 | 115 | 22.2 | 1.0 | 3800123119538 |
| 160115 | 115 | 22.2 | 1.2 | 3800123113000 |
| 160106 | 115 | 22.2 | 1.6 | 3800123126314 |
| 160101 | 115 | 22.2 | 3.2 | 3800123126031 |
| 160119 | 125 | 22.2 | 1.0 | 3800123119545 |
| 160116 | 125 | 22.2 | 1.2 | 3800123113604 |
| 160117 | 125 | 22.2 | 1.6 | 3800123113611 |
| 160102 | 125 | 22.2 | 3.2 | 3800123126550 |
| 160113 | 150 | 22.2 | 3.2 | 3800123127274 |
| 160107 | 180 | 22.2 | 2.0 | 3800123126321 |
| 160103 | 180 | 22.2 | 3.2 | 3800123126048 |
| 160108 | 230 | 22.2 | 2.0 | 3800123126338 |
| 160104 | 230 | 22.2 | 3.2 | 3800123126086 |
| 160105 | 355 | 25.4 | 3.2 | 3800123126284 |

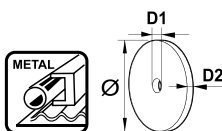

COLOR BOX

CUTTING DISC STONE

[BG] Диск за неметал • [RO] Disc taierei usoare-non metal • [SR] Rezna ploča • [MK] Диск за сечење
 Отрезной диск • [SL] Rezne plošče - kovina • [EL] Δίσκος κοπής • [HR] Ploča za rezanje cigli
 [FR] Disque de coupe en pierre • [IT] Disco da taglio • [ES] Tranca Disko Štono • [PT] Pedra de disco de corte

| art. № | Ø (mm) | D1 (mm) | D2 (mm) | BARCODE |
|--------|--------|---------|---------|---------------|
| 161101 | 115 | 22.2 | 3.2 | 3800123126307 |
| 161102 | 180 | 22.2 | 3.2 | 3800123126093 |
| 161103 | 230 | 22.2 | 3.2 | 3800123126109 |

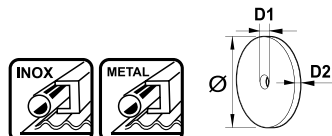

COLOR BOX

CUTTING DISC METAL

[BG] Диск за метал • [RO] Disc pentru taiat metal • [SR] Rezna ploča za metal • [MK] Диск за сечење на метал
 [RU] Отрезной диск для резки металла • [SL] Rezne plošče - kovina • [EL] Δίσκος κοπής μετάλλου • [HR] Ploča za rezanje metal
 • [FR] Scie circulaire • [IT] Disco da taglio • [ES] Tranca Disko • [PT] Disco de corte

| art. № | Ø (mm) | D1 (mm) | D2 (mm) | BARCODE |
|--------|--------|---------|---------|---------------|
| 160122 | 115 | 22.2 | 2.5 | 3800123166495 |
| 160123 | 115 | 22.2 | 3.0 | 3800123166501 |
| 160124 | 125 | 22.2 | 2.5 | 3800123166518 |
| 160125 | 125 | 22.2 | 3.0 | 3800123166525 |
| 160126 | 180 | 22.2 | 3.0 | 3800123166532 |
| 160127 | 230 | 22.2 | 2.0 | 3800123166549 |
| 160128 | 230 | 22.2 | 3.0 | 3800123166556 |
| 160129 | 350 | 25.4 | 3.5 | 3800123166563 |

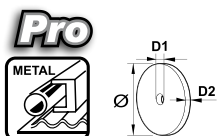

COLOR BOX

GRINDING DISC METAL

[BG] Диск за шлайфане • [RO] Disc abraziv • [SR] Brusna ploča za metal • [MK] Диск за брусење на метал
 [RU] Диск шлифовальный по металлу • [SL] Plošče za brušenje - kovina • [EL] Δίσκος λείονσης των μετάλλων
 • [HR] Brusna ploča • [FR] Disque de meulage en métal • [IT] Disco abrasivo • [ES] Muelanta Diskon • [PT] Disco de moagem

| art. № | Ø (mm) | D1 (mm) | D2 (mm) | BARCODE |
|--------|--------|---------|---------|---------------|
| 160109 | 115 | 22.2 | 6 | 3800123126604 |
| 160110 | 125 | 22.2 | 6 | 3800123126567 |
| 160111 | 180 | 22.2 | 6 | 3800123126574 |
| 160112 | 230 | 22.2 | 6 | 3800123126581 |

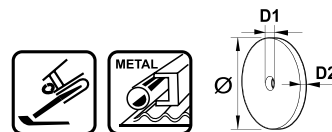

COLOR BOX

CUTTING DISC METAL A60T INOX

[BG] Диск за метал A60T Inox • [RO] Disc pentru taiat metal A60T Inox • [SR] Rezna ploča za metal A60T Inox • [MK] Диск за сечење на метал
 [RU] Отрезной диск для резки металла A60T Inox • [SL] Rezne plošče - kovina • [EL] Δίσκος κοπής μετάλλου • [HR] Ploča za rezanje metal A60T Inox • [FR] Disque de meulage en métal • [IT] Disco abrasivo • [ES] Muelanta Diskon • [PT] Disco de moagem

| art. № | Ø (mm) | D1 (mm) | D2 (mm) | BARCODE |
|--------|--------|---------|---------|---------------|
| 160120 | 115 | 22.2 | 1.0 | 3800123166471 |
| 160121 | 125 | 22.2 | 1.0 | 3800123166488 |

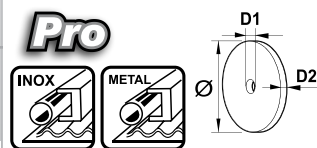

COLOR BOX

CUTTING DISC METAL

[BG] Диск за метал • [RO] Disc pentru taiat metal • [SR] Rezna ploča za metal • [MK] Диск за сечење на метал
 [RU] Отрезной диск для резки металла • [SL] Rezne plošče - kovina • [EL] Δίσκος κοπής μετάλλου • [HR] Ploča za rezanje metal
 • [FR] Disque de coupe en métal • [IT] Disco da taglio in metallo • [ES] Trancanta Diskon Metalo • [PT] Metal de disco de corte

| art. № | Ø (mm) | D1 (mm) | D2 (mm) | BARCODE |
|--------|--------|---------|---------|---------------|
| 160152 | 125 | 22.2 | 1.0 | 3800972014633 |



10pcs

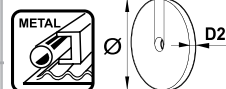

METAL BOX

GRINDING DISC METAL

[BG] Диск за неметал • [RO] Disc taierei usoare-non metal • [SR] Rezna ploča • [MK] Диск за сечење
 [RU] Отрезной диск • [SL] Rezne plošče • [EL] Δίσκος κοπής • [HR] Ploča za rezanje cigli
 • [FR] Disque de coupe en pierre • [IT] Disco da taglio • [ES] Tranca Disko Štono • [PT] Pedra de disco de corte

| art. № | Ø (mm) | D1 (mm) | D2 (mm) | BARCODE |
|--------|--------|---------|---------|---------------|
| 160134 | 115 | 22.2 | 3.0 | 3800123166617 |
| 160135 | 125 | 22.2 | 3.0 | 3800123166624 |
| 160136 | 180 | 22.2 | 3.0 | 3800123166631 |
| 160137 | 230 | 22.2 | 3.0 | 3800123166648 |

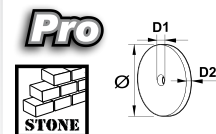

STONE

GRINDING DISC METAL

[BG] Диск за шлайфане • [RO] Disc abraziv • [SR] Brusna ploča za metal • [MK] Диск за брусење на метал • [RU] Диск шлифовальный по металлу • [SL] Plošče za brušenje - kovina • [EL] Δίσκος λείανσης των μετάλλων • [HR] Brusna ploča • [FR] Disque de meulage en métal • [IT] Disco abrasivo • [ES] Muelanta Diskon • [PT] Disco de moagem

| art. № | Ø (mm) | D1 (mm) | D2 (mm) | BARCODE |
|--------|--------|---------|---------|---------------|
| 160144 | 115 | 22.2 | 6.0 | 3800123166570 |
| 160145 | 125 | 22.2 | 6.0 | 3800123166587 |
| 160146 | 180 | 22.2 | 6.0 | 3800123166594 |
| 160147 | 230 | 22.2 | 6.0 | 3800123166600 |

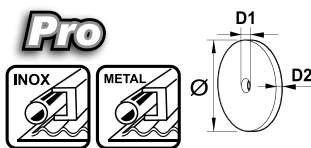

DISC FOR ANGLE GRINDER CARBIDE MULTI WHEEL

[BG] Диск за ъглошлайф Carbide Multi Wheel • [RO] Disc pentru polizor unghiular Carbide Multi Wheel • [SR] Disk za kutnu brusilicu Carbide Multi Wheel • [MK] Диск за мелење на агол Карбид Мулти тркало • [RU] Диск для угловой шлифовальной машины Carbide Multi Wheel • [SL] Disk za kotni brusilnik Carbide Multi Wheel • [EL] Κύκλοι κοπής διαμαντιών DRY • [HR] Dijamantne ploče DRY • [FR] Disque de coupe le diamant • [IT] Diamond Disco da taglio • [ES] Tranča disko • [PT] Diamond Disco de corte

| art. № | Ø (mm) | D1 (mm) | BARCODE |
|--------|--------|-----------|---------------|
| 160153 | 115 | 22.2 (20) | 3800972015234 |
| 160154 | 125 | 22.2 (20) | 3800972015241 |



DISC FOR BISCUIT JOINER

[BG] Диск за фреза за плоски дибли (Бисквит Машина) • [RO] Disc pentru masina de frezat - dibluri plate • [SR] Rezna ploča za glodalica za žljebove • [MK] Диск за гладалка за жлеbove • [RU] Отрезной диск для фрезы для плоских шкантов • [SL] Rezalne plošče za lamelni rezalniki • [EL] Δίσκος κοπής Φρεζ(οκαβιλιέρα) • [HR] Ploča za rezanje za Glodalica Za Utore • [FR] Disque de coupe pour le moulin pour goujons plats • [IT] Disco da taglio per il mulino per tasselli piatti • [ES] Tranča disko por la Muelejo por Platformaj Dokaloj • [PT] Disco de corte para o moinho para buchas planas

| art. № | Ø (mm) | D1 (mm) | Thickness/mm | teeth | BARCODE |
|--------|--------|-----------|--------------|-------|---------------|
| 163141 | 100 | 22.2 (20) | 4 | 6 | 3800123167553 |

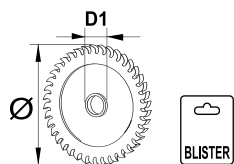

CIRCULAR SAW BLADE METAL AND WOOD FOR RD-CS25

[BG] Диск за циркуляр за метал и дърво • [RO] Disc circular metal și lemn • [SR] List testere metal i drvo • [MK] Кружна Пила за метал и дрво • [RU] Циркулярный диск для металл и дерево • [SL] List za krožno žago kovine in lesa • [EL] Διακοπριονα μέταλλο και ξύλο • [HR] Listova pila za metal i drvo • [FR] Lame de scie circulaire métal et bois • [IT] Lama per seghe circolari in metallo e legno • [ES] Circular Saw Blade Metalu kaj Ligno • [PT] Lâmina de serra circular de metal e madeira

| art. № | Ø (mm) | D1 (mm) | teeth | BARCODE |
|--------|--------|---------|-------|---------------|
| 163139 | 110 | 20 | 24 | 3800123167560 |

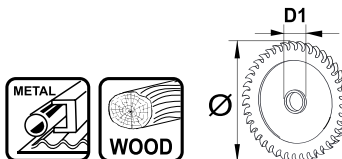

CIRCULAR SAW BLADE

[BG] Диск за циркуляр • [RO] Disc circular • [SR] List testere • [MK] Кружна Пила за Дрво • [RU] Циркулярный диск • [SL] List za krožno žago • [EL] Διακοπριονα • [HR] Listova pila • [FR] Lame de scie circulaire • [IT] Lama per seghe circolari • [ES] Vidita klingo • [PT] Lâmina de serra circular

| art. № | Ø (mm) | D1 (mm) | D1 (ring) | teeth (pcs) | BARCODE |
|--------|--------|---------|------------|-------------|---------------|
| 163137 | 85 | 10 | - | 30 | 3800123166105 |
| 163138 | 85 | 10 | - | 80 | 3800123166112 |
| 163113 | 115 | 22.2 | 16 20 | 24 | 3800123126079 |
| 163134 | 115 | 22.2 | 16 20 | 36 | 3800123158247 |
| 163131 | 125 | 22.2 | 16 20 | 40 | 3800123141843 |
| 163106 | 160 | 20 | 16 | 24 | 3800123126628 |
| 163102 | 180 | 20 | 16 | 24 | 3800123126116 |
| 163128 | 185 | 20 | 16 | 24 | 3800123139420 |
| 163132 | 185 | 20 | 16 | 60 | 3800123141850 |
| 163135 | 190 | 20 | 16 | 24 | 3800123158810 |
| 163129 | 190 | 25.4 | 16 20 | 40 | 3800123139437 |
| 163136 | 190 | 20 | 16 | 80 | 3800123158827 |
| 163130 | 200 | 16 | - | 24 | 3800123139444 |
| 163104 | 210 | 25.4 | 16 20 | 24 | 3800123126635 |
| 163133 | 210 | 30 | 20 25.4 | 24 | 3800123143694 |
| 163115 | 210 | 30 | 20 25.4 | 60 | 3800123160004 |
| 163103 | 230 | 22.2 | 16 20 | 40 | 3800123126383 |
| 163116 | 250 | 30 | 20 25.4 | 48 | 3800123160707 |
| 163117 | 250 | 30 | 20 25.4 | 60 | 3800123160714 |
| 163114 | 254 | 25.4 | 16 20 | 60 | 3800123127953 |
| 163107 | 300 | 25.4 | 16 20 | 56 | 3800123126659 |

| art. № | Ø (mm) | D1 (mm) | D1 (ring) | teeth (pcs) | BARCODE |
|--------|--------|---------|------------|-------------|---------------|
| 163110 | 300 | 30 | 20 25.4 | 56 | 3800123126949 |
| 163144 | 305 | 30 | - | 100 | 3800972010772 |
| 163126 | 315 | 30 | 20 25.4 | 40 | 3800123127496 |
| 163108 | 350 | 25.4 | 16 20 | 56 | 3800123126666 |
| 163111 | 350 | 30 | 20 25.4 | 56 | 3800123126956 |
| 163109 | 400 | 25.4 | 16 20 | 56 | 3800123126673 |
| 163112 | 400 | 30 | 20 25.4 | 56 | 3800123126963 |
| 163145 | 190 | 30 | - | 24 | 3800972019584 |
| 163146 | 190 | 30 | - | 36 | 3800972019591 |
| 163147 | 190 | 30 | - | 48 | 3800972019607 |
| 163148 | 190 | 30 | - | 60 | 3800972019614 |
| 163149 | 200 | 30 | - | 24 | 3800972019621 |
| 163150 | 210 | 30 | - | 48 | 3800972019638 |
| 163151 | 254 | 30 | - | 40 | 3800972019645 |
| 163152 | 254 | 30 | - | 80 | 3800972019652 |

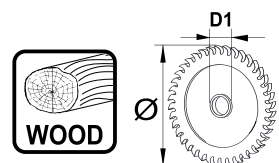

FOR ALUMINUM / ЗА РЪЗАНЕ НА АЛУМИНИЙ

| art. № | Ø (mm) | D1 (mm) | D1 (ring) | teeth (pcs) | BARCODE |
|--------|--------|---------|-----------|-------------|---------------|
| 163118 | 255 | 25.4 | 16 20 | 100 | 3800123160721 |



FLAP DISC

[BG] Диск ламелен • [RO] Disc ptr slefuit • [SR] Brusni papir lamelni • [MK] Ламинарен абразивен диск • [RU] Плита диска • [SL] Lamelna brusilna plošča • [EL] Δίσκοι με πτερύγια από χαρτί λείανσης • [HR] Lamelirane brusne ploče • [FR] Plaques de meulage lamellaires • [IT] Piastre di macinazione lamellare • [ES] Lamellar muelanta telerojn • [PT] Placas de moagem lamelar

| art. № | Ø ₁ (mm) | Ø ₂ (mm) | A | BARCODE |
|--------|------------------------|------------------------|-------|---------------|
| 164112 | 115 | 22 | A-40 | 3800123127298 |
| 164102 | 115 | 22 | A-60 | 3800123126352 |
| 164103 | 115 | 22 | A-80 | 3800123126369 |
| 164104 | 115 | 22 | A-100 | 3800123126376 |
| 164105 | 115 | 22 | A-120 | 3800123126543 |
| 164113 | 115 | 22 | A-150 | 3800123150746 |
| 164118 | 125 | 22 | A-40 | 3800123151095 |
| 164119 | 125 | 22 | A-60 | 3800123151101 |
| 164120 | 125 | 22 | A-80 | 3800123151118 |
| 164121 | 125 | 22 | A-100 | 3800123151125 |
| 164122 | 125 | 22 | A-120 | 3800123151132 |
| 164123 | 125 | 22 | A-150 | 3800123151149 |

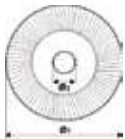

EN 13743



FLAP WHEEL BURNISHING MOP FOR POWER DRILL

[BG] Диск за сваляне на ръжда за бормашина • [RO] Perie segmentata smirghel-cu tija • [SR] Brusna lepeza [MK] Абразивен диск за бормашина • [RU] Дрель и лепестковая шлифовальная насадка • [SL] Lamelasti kolut na osovini • [EL] Πολύπτερο γυαλόχαρτο • [HR] Lepezasti brusni kolut • [FR] Disque pour enlever la rouille • [IT] Disco per rimuovere la ruggine • [ES] Disko por forigi ruston • [PT] Disco para remoção de ferrugem

Ø 64mm

Art. No. 209920

EAN: 3800123127625



WIRE CUP BRUSH BRASSED WITH SHANK

[BG] Четка за бормашина камбана месинг • [RO] Perie sarma rotativa • [SR] Četka čelična kružna mesing • [MK] Жичана Челична Четка • [RU] Щетка чашки волнистой • [SL] Žična ščetka • [EL] Συρμάτινη βούρτσα τροχού • [HR] Lončasta žičana četka za bušilice - valovita žica • [FR] Brosse de perceuse en laiton • [IT] Spazzola per trapano in ottone • [ES] Drilo Broso • [PT] Escova de broca de latão

| art. № | Ø (mm) | BARCODE |
|--------|-----------|---------------|
| 170101 | 50 (2") | 3800123102042 |
| 170102 | 75 (3") | 3800123102059 |
| 170103 | 100 (4") | 3800123102066 |



TWIST KNOT WIRE CUP BRUSH WITH SHANK FOR RDP-CDL01

[BG] Четка за бормашина камбана плетена • [RO] Perie sarma rotativa pentru masina de gaurit • [SR] Četka čelična kružna za bušilica • [MK] Жичана челична четка за бормашина • [RU] Щетка чашки волнистой за дрель [SL] Žična ščetka za udarni vrtalnik • [EL] Συρμάτινη βούρτσα τροχού για κρουστικό δρασπανο • [HR] Ravna žičana četka • [FR] Brosse de forage • [IT] Pennello da trapano • [ES] Cepillo de taladro • [PT] Escova de perfuração

Ø 25mm (1")

Art. No. 170107

EAN: 3800123163661



TWIST KNOT WIRE CUP BRUSH WITH SHANK

[BG] Четка за бормашина камбана плетена • [RO] Perie sarma rotativa pentru masina de gaurit • [SR] Četka čelična kružna za bušilica • [MK] Жичана челична четка за бормашина • [RU] Щетка чашки волнистой за дрель [SL] Žična ščetka za udarni vrtalnik • [EL] Συρμάτινη βούρτσα τροχού για κρουστικό δρασπανο • [HR] Ravna žičana četka • [FR] Brosse de forage • [IT] Pennello da trapano • [ES] Cepillo de taladro • [PT] Escova de perfuração

Ø 75mm (3")

Art. No. 170109

EAN: 3800123163685



WIRE WHEEL BRUSH BRASSED WITH SHANK

[BG] Четка за бормашина плоска месинг • [RO] Perie sarma cu tija ptr bormasina • [SR] Četka čelična ravna mesing • [MK] Жичана Челична Четка • [RU] Стальная латунированная волнистая проволока • [SL] Žična ščetka • [EL] Συρμάτινη βούρτσα τροχού • [HR] Plosnata žičana četka - valovita žica • [FR] Brosse de forage • [IT] Pennello da trapano • [ES] Cepillo de taladro • [PT] Escova de perfuração

| art. № | Ø (mm) | BARCODE |
|--------|-----------|---------------|
| 170104 | 50 (2") | 3800123102073 |
| 170105 | 75 (3") | 3800123102080 |
| 170106 | 100 (4") | 3800123102097 |



TWIST KNOT WIRE WHEEL BRUSH WITH SHANK

[BG] Четка за бормашина плоска плетена • [RO] Perie circulara rotativa • [SR] Četka čelična ravna upletena • [MK] Жичана Челична Четка (Увртена) • [RU] Стальная переплетенная щетка • [SL] Lončasta ščetka - pletena žica • [EL] Ποτηροειδής βούρτσα – πλεγμένο σύρμα • [HR] Plosnata žičana četka - pletena • [FR] Brosse de forage • [IT] Pennello da trapano • [ES] Cepillo de taladro • [PT] Escova de perfuração

Ø 75mm (3")

Art. No. 170108

EAN: 3800123163678



WIRE CUP BRUSH BRASSED FOR ANGLE GRINDER

[BG] Четка за ъглошлиф камбана месинг • [RO] Set 20 buc perii sarma pentru bormasina • [SR] Četka čelična kružna mesing • [MK] Жичана Челична Четка [RU] Щетка чашки волнистой [SL] Žična ščetka • [EL] Συρμάτινη βούρτσα τροχού • [HR] Lončasta žičana četka - valovita žica • [FR] Brosse d'angle • [IT] Spazzola smerigliatrice angolare • [ES] Cepillo de amoladora angular • [PT] Escova de rebarbadora

| art. № | Ø (mm) | BARCODE |
|--------|--------|---------------|
| 171103 | 75 | 3800123102103 |
| 171106 | 100 | 3800123102110 |
| 171121 | 125 | 3800123151248 |



COLOR BOX

TWIST KNOT WIRE CUP BRUSH FOR ANGLE GRINDER

[BG] Четка за ъглошлиф камбана плетена • [RO] Set 3 buc perii sarma pentru bormasina • [SR] Četka čelična kružna upletena • [MK] Жичана Челична Четка (Увртена) • [RU] Стальная переплетенная щетка • [SL] Lončasta ščetka - pletena žica • [EL] Ποτρωειδής βούρτσα - πλεγμένο σύρμα • [HR] Lončasta žičana četka - pletena čelična žica • [FR] Brosse d'angle • [IT] Spazzola smerigliatrice angolare • [ES] Cepillo de amoladora angular • [PT] Escova de rebarbadora

| art. № | Ø (mm) | BARCODE |
|--------|--------|---------------|
| 171101 | 75 | 3800123102127 |
| 171104 | 100 | 3800123102134 |
| 171107 | 125 | 3800123102141 |



COLOR BOX

TWIST KNOT WIRE CUP BRUSH HEAVY DUTY FOR ANGLE GRINDER

[BG] Четка за ъглошлиф камбана плетена усилена • [RO] Perie sarma rotativa • [SR] Četka čelična kružna upletena • [MK] Жичана Челична Четка (Увртена) • [RU] Стальная переплетенная щетка • [SL] Lončasta ščetka - pletena žica • [EL] Ποτρωειδής βούρτσα - πλεγμένο σύρμα • [HR] Lončasta žičana četka - pletena čelična žica • [FR] Brosse d'angle • [IT] Spazzola smerigliatrice angolare • [ES] Cepillo de amoladora angular • [PT] Escova de rebarbadora

| art. № | Ø (mm) | BARCODE |
|--------|--------|---------------|
| 171102 | 75 | 3800123102158 |
| 171105 | 100 | 3800123102165 |



COLOR BOX

TWIST KNOT WIRE SAUCER CUP BRUSH FOR ANGLE GRINDER

[BG] Четка за ъглошлиф конусна плетена • [RO] Perie sarma rotativa • [SR] Četka čelična kružna upletena • [MK] Жичана Челична Четка (Увртена) • [RU] Стальная переплетенная щетка • [SL] Lončasta ščetka - pletena žica • [EL] Ποτρωειδής βούρτσα - πλεγμένο σύρμα • [HR] Plosnata žičana četka • [FR] Brosse d'angle • [IT] Spazzola smerigliatrice angolare • [ES] Cepillo de amoladora angular • [PT] Escova de rebarbadora

Ø 100mm

Art. No. 171122
EAN: 3800123163630



BLISTER

TWIST KNOT WIRE WHEEL BRUSH FOR ANGLE GRINDER

[BG] Четка за ъглошлиф плоска плетена • [RO] Perie circulara rotativa • [SR] Četka čelična ravna upletena • [MK] Жичана Челична Четка (Увртена) • [RU] Стальная переплетенная щетка • [SL] Lončasta ščetka - pletena žica • [EL] Ποτρωειδής βούρτσα - πλεγμένο σύρμα • [HR] Plosnata žičana četka - pletena • [FR] Brosse d'angle • [IT] Spazzola smerigliatrice angolare • [ES] Cepillo de amoladora angular • [PT] Escova de rebarbadora

| art. № | Ø (mm) | BARCODE |
|--------|--------|---------------|
| 171108 | 100 | 3800123102172 |
| 171109 | 150 | 3800123102189 |
| 171110 | 200 | 3800123102288 |



COLOR BOX

WIRE BRUSHES BRASSED WITH SHANK 3 PCS SET

[BG] Четки за бормашина месинг 3 бр. комплект • [RO] 3 Pcs/Set perii sarma ptr bormasina • [SR] Četka čelična set 3 kom • [MK] Жичана Челична Четка сет 3 ком месинг • [RU] Щетка волнистой проволоки круговая набор 3 шт. • [SL] Žične ščetke 3 kos • [EL] Ποτρωειδής βούρτσα Σет 3 τεμάχια • [HR] Čelične žičane četke 3 kom. • [FR] Brosses pour perceuse en laiton 3 pcs. kit • [IT] Spazzole per trapano in ottone 3 pz. set • [ES] Cepillos para taladro de latón 3 uds. kit • [PT] Escovas para broca de latão 3 peças. kit

3pcs

Art. No. 177101
EAN: 3800123102240



BLISTER

WIRE WHEEL BRUSH BRASSED FOR BENCH GRINDER

[BG] Четка за шмиргел месинг • [RO] Perie circulara din sarma • [SR] Četka čelična za oštrač mesing • [MK] Жичана Челична Четка за струг месинг • [RU] Щетка волнистой проволоки круговая • [SL] Žične ščetke za dvojno brusilno napravo • [EL] Ποτρωειδής βούρτσα • [HR] Plosnata žičana četka - valovita žica • [FR] Brosse en laiton • [IT] Pennello in ottone • [ES] Cepillo de latón • [PT] Escova para lixadeira

| art. № | Ø (mm) | BARCODE |
|--------|----------|---------------|
| 172101 | 125 (5") | 3800123102196 |
| 172102 | 150 (6") | 3800123102202 |
| 172103 | 200 (8") | 3800123102219 |



COLOR BOX

WIRE BRUSHES BRASSED WITH SHANK 20 PCS SET

[BG] Четки за бормашина месинг 20 бр. комплект • [RO] 20 Pcs/Set perii sarma ptr bormasina • [SR] Četka čelična set 20 kom • [MK] Жичана Челична Четка сет 20 ком месинг • [RU] Щетка волнистой проволоки круговая набор 20 шт. • [SL] Žične ščetke 20 kos • [EL] Ποτρωειδής βούρτσα Σет 20 τεμάχια • [HR] Čelične žičane četke 20 kom. • [FR] Brosses pour perceuse en laiton 20 pcs. kit • [IT] Spazzole per trapano in ottone 20 pz. set • [ES] Cepillos para taladro de latón 20 uds. kit • [PT] Escovas para broca de latão 20 peças. kit

20pcs

Art. No. 177103
EAN: 3800123102264



COLOR BOX

SANDING SHEETS FOR SANDER WITH 8 HOLES 10PCS

[BG] Шкурка за виброшлайф с 8 отвора 10бр • [RO] Set 10 buc banda smirghel perforate • [SR] Brusni papir 10 kom • [MK] Абразивна Хартија 10 ком • [RU] Бумага наждачная 10 шт. • [SL] Brusni platna 10 kos • [EL] Γυαλόχαρτο Σετ 10 τεμάχια • [HR] Brusni papir 10 kom. • [FR] Ponçeuse pour broyeur vibrant 10 pcs. • [IT] Levigatrice per smerigliatrice vibrante 10 pz. • [ES] Lijadora para amoladora vibratoria 10 uds. • [PT] Lixadeira para moedor vibratório 10 pcs.

| art. № | L1 (mm) | L2 (mm) | P | BARCODE |
|--------|---------|---------|------|---------------|
| 180101 | 93 | 230 | P60 | 3800123135446 |
| 180112 | 93 | 230 | P80 | 3800123150555 |
| 180102 | 93 | 230 | P100 | 3800123135453 |
| 180103 | 93 | 230 | P120 | 3800123135460 |
| 180113 | 93 | 230 | P150 | 3800123150562 |
| 180104 | 93 | 230 | P180 | 3800123135477 |
| 180105 | 93 | 230 | P240 | 3800123135484 |
| 180114 | 115 | 280 | P40 | 3800123150579 |
| 180106 | 115 | 280 | P60 | 3800123135491 |
| 180115 | 115 | 280 | P80 | 3800123150586 |
| 180107 | 115 | 280 | P100 | 3800123135507 |
| 180108 | 115 | 280 | P120 | 3800123135514 |
| 180116 | 115 | 280 | P150 | 3800123150593 |
| 180109 | 115 | 280 | P180 | 3800123135521 |
| 180110 | 115 | 280 | P220 | 3800123135538 |

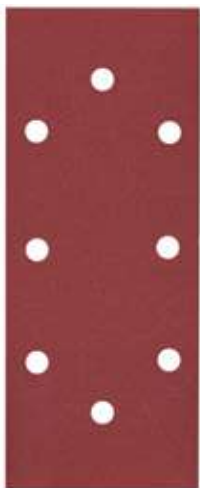

10pcs / 8holes

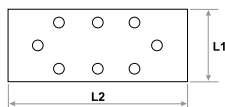

SANDING BELTS FOR BENCH GRINDER WITH SANDING BELT 5 PCS

[BG] Шкурка за лентов шмиргел 5 бр • [RO] Set 5 buc banda smirghel • [SR] Brusna traka Set 5 kom • [MK] Абразивна Трака 5 ком [RU] Лента для шлифмашины 5 шт. • [SL] Brusni trakovi kovina 5 kos • [EL] Ιμαντες λειανσης 5 τεμάχια • [HR] Brusna traka za Stolna brusilica 5 kom • [FR] Papier abrasif pour bande abrasive 5pcs. • [IT] Carta abrasiva per levigatura della cinghia 5 pezzi. • [ES] Papel de lija para lijador cinta 5 pcs. • [PT] Lixa para cinto de lixar 5pcs.

5pcs / 50x686mm

| art. № | P | BARCODE |
|--------|------|---------------|
| 183116 | P40 | 3800123135309 |
| 183117 | P60 | 3800123135316 |
| 183118 | P80 | 3800123135323 |
| 183119 | P100 | 3800123135330 |
| 183120 | P120 | 3800123136252 |



SANDING BELTS FOR BELT SANDER 5 PCS

[BG] Шкурка за лентов шлайф 5 броя • [RO] Set 5 buc banda smirghel • [SR] Brusna traka Set 5 kom [MK] Абразивна Трака 5 ком • [RU] Лента для шлифмашины 5 шт. • [SL] Brusni trakovi kovina 5 kos [EL] Ιμαντες λειανσης 5 τεμάχια • [HR] Brusna traka za Tračne brusilice 5 kom • [FR] Papier abrasif pour 5 meuleuses à bande • [IT] Carta abrasiva per 5 smerigliatrici a nastro • [ES] Papel de lija para 5 amoladoras de cinta • [PT] Lixa para 5 moedores de correia

| art. № | mm | P | BARCODE |
|--------|--------|------|---------------|
| 183111 | 75x457 | P40 | 3800123135170 |
| 183112 | 75x457 | P60 | 3800123135187 |
| 183113 | 75x457 | P80 | 3800123135194 |
| 183114 | 75x457 | P100 | 3800123135200 |
| 183115 | 75x457 | P120 | 3800123135224 |
| 183106 | 75x533 | P40 | 3800123135996 |
| 183107 | 75x533 | P60 | 3800123136009 |
| 183108 | 75x533 | P80 | 3800123136207 |
| 183109 | 75x533 | P100 | 3800123135156 |
| 183110 | 75x533 | P120 | 3800123135163 |



5pcs



PAPER SANDING DISCS VELCRO 10PCS

[BG] Шкурка VELCRO 10 бр. • [RO] Set 10 buc banda smirghel circulara Velcro • [SR] Brusni papir VELCRO 10 kom • [MK] Абразивна Хартија VELCRO 10 ком • [RU] Бумага наждачная 10 шт. • [SL] Brusni platna 10 kos • [EL] Γυαλόχαρτο Σετ 10 τεμάχια • [HR] Brusni papir VELCRO 10 kom • [FR] Disques à poncer VELCRO 10pcs • [IT] Dischi abrasivi per carta VELCRO 10 pezzi • [ES] Discos de lija de papel VELCRO 10 piezas • [PT] Discos de lixamento de papel VELCRO 10pcs

| art. № | ∅ (mm) | P | BARCODE |
|--------|--------|------|---------------|
| 180702 | 115 | K40 | 3800123134906 |
| 180703 | 115 | K60 | 3800123134913 |
| 180704 | 115 | K80 | 3800123134920 |
| 180705 | 115 | K100 | 3800123134937 |
| 180706 | 115 | K120 | 3800123134944 |

10pcs / ∅115mm

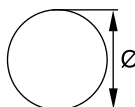

SANDING DISCS FOR RANDOM ORBIT SANDER WITH 8 HOLES 10PCS

[BG] Шкурка за ексцентършлайф с 8 отвора 10 бр • [RO] Set 10 buc banda smirghel slefuitor circular • [SR] Brusni papir 10 kom • [MK] Абразивна Хартија 10 ком • [RU] Бумага наждачная 10 шт. • [SL] Brusni platna 10 kos • [EL] Γυαλόχαρτο Σετ 10 τεμάχια • [HR] Brusni papir za Ekscentrične brusilice 10 kom • [FR] Disques de ponçage pour ponçeuse à orbite aléatoire avec 8 trous 10pcs • [IT] Dischi abrasivi per levigatrice orbitale casuale con 8 fori 10 pezzi • [ES] Discos de lijador para lijadora de órbita aleatoria con 8 orificios 10pcs • [PT] Discos de lixamento para lixadeira de órbita aleatória com 8 furos 10pcs

| art. № | ∅ (mm) | P | BARCODE |
|--------|--------|------|---------------|
| 181101 | 125 | K60 | 3800123135545 |
| 181102 | 125 | K120 | 3800123135552 |
| 181103 | 125 | K180 | 3800123135569 |
| 181104 | 125 | K240 | 3800123135576 |

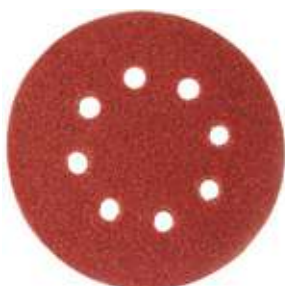

10pcs / 8holes

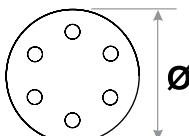

PAPER SANDING DISCS VELCRO WITH 6 HOLES 10PCS

[BG] Шкурка VELCRO с 6 отвора 10 бр. • [RO] Set 10 buc banda circulara smirghel • [SR] Brusni papir VELCRO 10 kom • [MK] Абразивна Хартија VELCRO 10 ком • [RU] Бумага наждачная 10 шт. • [SL] Brusni platna 10 kos • [EL] γυαλόχαρτο Σετ 10 τεμάχια • [HR] Brusni papir VELCRO 10 kom • [FR] Disques à poncer VELCRO 10pcs • [IT] Dischi abrasivi per carta VELCRO 10 pezzi • [ES] Discos de lija de papel VELCRO 10 piezas • [PT] Discos de lixamento de papel VELCRO 10pcs

| art. № | ∅ (mm) | P | BARCODE |
|--------|--------|------|---------------|
| 180713 | 150 | K60 | 3800123165412 |
| 180714 | 150 | K80 | 3800123165429 |
| 180715 | 150 | K100 | 3800123165436 |
| 180716 | 150 | K120 | 3800123165443 |
| 180717 | 150 | K150 | 3800123165450 |
| 180718 | 150 | K180 | 3800123165467 |
| 180719 | 150 | K220 | 3800123165474 |
| 180720 | 150 | K240 | 3800123165481 |

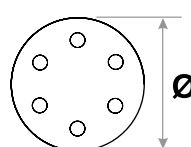
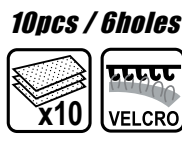

PAPER SANDING SHEET VELCRO

[BG] Шкурка VELCRO • [RO] Benzi circulare smirghel VELCRO • [SR] Brusni papir VELCRO • [MK] Абразивна Хартија VELCRO • [RU] Бумага наждачная • [SL] Brusni platna VELCRO • [EL] Γυαλόχαρτο VELCRO • [HR] Brusni papir VELCRO • [FR] Disques à poncer VELCRO 10pcs • [IT] Dischi abrasivi per carta VELCRO • [ES] Discos de lija de papel VELCRO • [PT] Discos de lixamento de papel VELCRO

PAPER SANDING DISC VELCRO FOR LONG-NECK SANDERS VELCRO

| art. № | Ø (mm) | grit | BARCODE |
|--------|--------|------|---------------|
| 180721 | 225 | 80 | 3800123166266 |
| 180724 | 225 | 100 | 3800123166723 |
| 180722 | 225 | 120 | 3800123166273 |
| 180723 | 225 | 150 | 3800123166280 |
| 180725 | 225 | 180 | 3800972002180 |

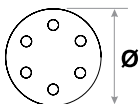

TRIANGULAR SANDING SHEETS

| art. № | Ø (mm) | grit | BARCODE |
|--------|--------|------|---------------|
| 180726 | 285 | 80 | 3800972003378 |
| 180727 | 285 | 100 | 3800972003385 |
| 180728 | 285 | 120 | 3800972003392 |
| 180729 | 285 | 150 | 3800972003408 |
| 180730 | 285 | 180 | 3800972003415 |

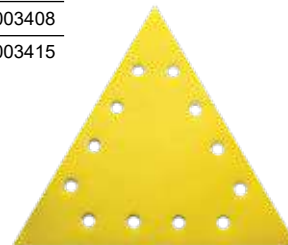
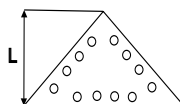

ABRASIVE FLAP WHEEL FOR POWER DRILL

[BG] Шкурка за бормашина ламелна • [RO] Perie segmentata smirghel • [SR] Brusni papir lerezasti • [MK] Ламинарен абразивен диск за бормашина • [RU] Диск лепестковый для дрели • [SL] Pahljačasti brusilnik • [EL] Γυαλόχαρτα κυλινδρική με άξονα • [HR] Lerezasti brusni čerovi • [FR] Roue à lamelles abrasive pour perceuse • [IT] Ruota lamellare abrasiva per trapano elettrico • [ES] Abrasive flap rado por potencia drilo [PT] Roda de aba abrasiva para furadeira

| art. № | Ø (mm) | | BARCODE |
|--------|--------|------|---------------|
| 183501 | 50 | K60 | 3800123135712 |
| 183502 | 50 | K120 | 3800123135729 |
| 183503 | 60 | K60 | 3800123135736 |
| 183504 | 60 | K120 | 3800123135743 |
| 183505 | 80 | K60 | 3800123135750 |
| 183506 | 80 | K120 | 3800123135767 |



DRYWALL PLASTER SANDING SCREEN 5 PCS

[BG] Шкурка мрежа от силициев карбид 5 бр. • [RO] Set 5 buc rezerva bagheta silicon • [SR] Brusni papir 5 kom • [MK] Абразивна Хартија 5 ком • [RU] Латекса абразивной бумага карбида 5 шт. • [SL] Brusni platna 5 kos • [EL] Σιλικεροχαρτο Σετ 5 τεμ • [HR] Brusna mreža silicij karbid • [FR] Écran de ponçage de plâtre pour cloisons sèches 5 PC • [IT] Rete di carta vetrata 5 pezzi • [ES] Reto de rekta flugo 5pcs • [PT] Rede de lixa 5 pcs

| art. № | L1 (mm) | L2 (mm) | | BARCODE |
|--------|---------|---------|------|---------------|
| 184101 | 93 | 230 | P40 | 3800123150609 |
| 184102 | 93 | 230 | P60 | 3800123150616 |
| 184103 | 93 | 230 | P80 | 3800123150623 |
| 184104 | 93 | 230 | P100 | 3800123150630 |
| 184105 | 93 | 230 | P120 | 3800123150647 |
| 184106 | 93 | 230 | P150 | 3800123150654 |

5pcs/ 93x230mm

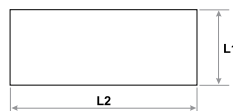

SANDING SPONGE

[BG] Гъба абразивна • [RO] Burete smirghel • [SR] Sunder za brušenje • [MK] Абразивен сунѓер • [RU] Абразивная губка • [SL] Gobice za ročno brušenje • [EL] Λειαντική Σφουγγάρι • [HR] Brusna spužva • [FR] Éponge de ponçage • [IT] Spugna abrasiva • [ES] Sanding-Spongo • [PT] Esponja de lixamento

| art. № | L1 (mm) | L2 (mm) | H (mm) | P | BARCODE |
|--------|---------|---------|--------|------|---------------|
| 189101 | 70 | 100 | 25 | P40 | 3800123136269 |
| 189102 | 70 | 100 | 25 | P60 | 3800123136276 |
| 189103 | 70 | 100 | 25 | P80 | 3800123136283 |
| 189104 | 70 | 100 | 25 | P100 | 3800123136290 |
| 189105 | 70 | 100 | 25 | P120 | 3800123136306 |
| 189106 | 70 | 100 | 25 | P150 | 3800123136313 |

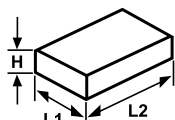

RAIDER
Accessories

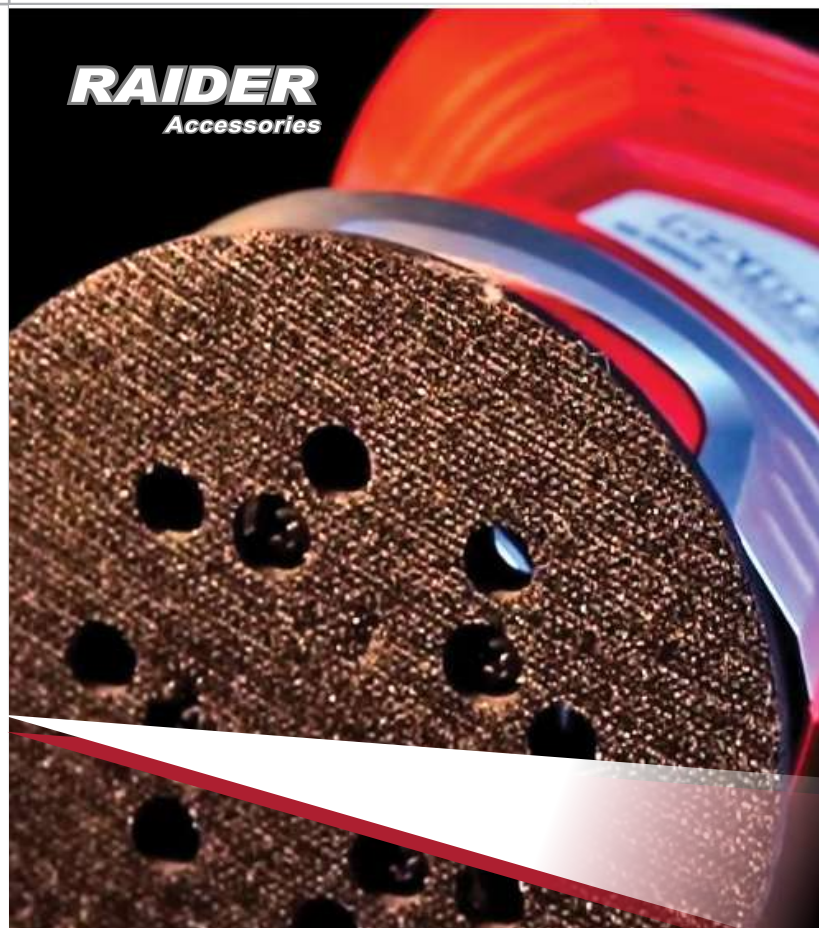

SCREWDRIVER BITS 1/4" 29 PCS SET

[BG] Накрайници 29 броя комплект • [RO] Set biti 29 buc • [SR] Pin Set 29 kom • [MK] Битови, Сет 29 Пар • [RU] Набор бит 29 пр • [SL] Set bit-nastavkov 29-delni komplet • [EL] Σет мүтес 29 τεμαχίων σε κασετίνα • [HR] Set bitovi 29 kom • [FR] Embouts de tournevis 1/4 "29 pièces • [IT] Set di cacciaviti 1/4 "Set 29 pezzi • [ES] Destornillataj Bitoj 1/4 "29 Pcs-Aro • [PT] Chave de fenda 1/4 "29 Pcs Set

| pcs | Name | Sizing |
|-----|---------------------|---|
| 24 | 25mm(L) BIT | <ul style="list-style-type: none"> 3PC SLOTTED: 3, 4, 5, 6, 7 mm 3PC PHILLIPS: PH1, PH2, PH3 3PC POZI: PZ1, PZ2, PZ3 4PC METRIC HEX: H3, H4, H5, H6 3PC SQUARE: #1, #2, #3 6PC STAR: T10, T15, T20, T25, T27, T30 |
| 2 | SCREWDRIVER BIT | 50 mm |
| 1 | COMPACT SCREW GUIDE | 80 mm Long |
| 2 | MAGNETIC NUT SETTER | 6,8 mm |

29pcs



1/4"

Art. No. 157792

EAN: 3800123169571



SCREWDRIVER BITS 1/4" 37 PCS SET

[BG] Накрайници 37 броя комплект • [RO] Set biti 37 buc • [SR] Pin Set 37 kom • [MK] Битови, Сет 37 Пар • [RU] Набор бит 37 пр • [SL] Set bit-nastavkov 37-delni komplet • [EL] Σет мүтес 37 τεμαχίων σε κασετίνα • [HR] Set bitovi 37 kom • [FR] Embouts de tournevis 37 pièces • [IT] Set di cacciaviti 37 pezzi • [ES] Destornillataj Bitoj 37 Pcs-Aro • [PT] Chave de fenda 37 Pcs Set Bitoj

| pcs | Name | Sizing |
|-----|---------------|--|
| 8 | 50 mm (L) BIT | <ul style="list-style-type: none"> 2PC SLOTTED: 5.5, 8 mm 3PC PHILLIPS: PH1, PH2, PH3 3PC POZI: PZ1, PZ2, PZ3 |
| 24 | 25 mm(L) BIT | <ul style="list-style-type: none"> 5PC SLOTTED: 3, 4, 5, 6, 7mm 3PC PHILLIPS: PH1, PH2, PH3 3PC POZI: PZ1, PZ2, PZ3 4PC METRIC HEX: H3, H4, H5, H6 3PC SQUARE: #1, #2, #3 6PC STAR: T10, T15, T20, T25, T27, T30 |
| 4 | NUT DRIVER | 5, 6, 8, 10 mm |
| 1 | BIT HOLDER | |

37pcs



1/4"

Art. No. 157793

EAN: 3800123169588



SCREWDRIVER BITS & DRILL BITS 1/4" 15 PCS SET

[BG] Накрайници и свредла 1/4" 15 броя комплект • [RO] Set burghie si biti 15 buc • [SR] Pinovi i burgije Set 15 kom • [MK] Битови и Бургии, Сет 15 Пар • [RU] Набор бит и сверл 15 пр • [SL] 15-delni set svedri in vijačni nastavki • [EL] Σет мүтес трупάνια 15 τεμαχίων • [HR] SET bitovi i svrdla 15 kom • [FR] Embouts de tournevis et embouts 1/4 "15 pièces • [IT] Giraviti e punte da trapano Set da 1/4 "15 pezzi • [ES] Disilador Bits & Drill Bits 1/4 "15 komputiloj • [PT] Chave de fendas e brocas 1/4 "15 peças

15pcs

| pcs | Name | Sizing |
|-----|-------------------------------|--|
| 7 | HSS DRILL BITS WITH HEX SHANK | Ø1.5, 2.0, 3.0, 4.0, 4.5, 5.0, 6.0 mm |
| 7 | 50mm (L) BIT | <ul style="list-style-type: none"> 2PC SLOTTED: 4, 5 mm 2PC PHILLIPS: PH2 x 2 2PC POZI: PZ2 x 2 1PC SQUARE: #2 |
| 1 | MAGNETIC HOLDER | 58 mm |



1/4"

Art. No. 157795

EAN: 3800123169601



SCREWDRIVER BITS & DRILL BITS 1/4" 20 PCS SET

[BG] Накрайници и свредла 1/4" 20 броя комплект • [RO] Set burghie si biti 20 buc • [SR] Pinovi i burgije Set 20 kom • [MK] Битови и Бургии, Сет 20 Пар • [RU] Набор бит и сверл 20 пр • [SL] 20-delni set svedri in vijačni nastavki • [EL] Σет мүтес трупάνια 20 τεμαχίων • [HR] SET bitovi i svrdla 20 kom • [FR] Embouts de tournevis et embouts 1/4 "20 pièces • [IT] Giraviti e punte da trapano Set da 1/4 "20 pezzi • [ES] Disilador Bits & Drill Bits 1/4 "20 komputiloj • [PT] Chave de fendas e brocas 1/4 "20 peças

20pcs

| pcs | Name | Sizing |
|-----|-------------------------------|---|
| 7 | HSS DRILL BITS WITH HEX SHANK | Ø1.5, 2.0, 3.0, 4.0, 4.5, 5.0, 6.0 mm |
| 9 | 50mm (L) BIT | <ul style="list-style-type: none"> 3PC SLOTTED: 4, 5, 6 mm 3PC PHILLIPS: PH1, PH2, PH3 3PC POZI: PZ1, PZ2, PZ3 |
| 3 | NUT DRIVER | 6, 8, 10mm |
| 1 | QUICK CHANGER | |



1/4"

Art. No. 157797

EAN: 3800123169625



SCREWDRIVER BITS & MAGNETIC HOLDER QUICK-CHANGE

[BG] Накрайници и магнитен държач бърз захват 1/4" 15 бр. к-т RAIDER • [RO] Set biti 15 buc • [SR] Pin Set 15 kom • [MK] Битови, Сет 15 пар • [RU] Набор бит 15 пр • [SL] Set bit-nastavkov 15-delni komplet • [EL] Σет мүтес 15 τεμαχίων σε κασετίνα • [HR] Set bitovi 1/4" 15 kom • [FR] Embouts de tournevis et support magnétique à changement rapide 1/4 "Set de 15 pièces • [IT] Set di cacciaviti e supporto magnetico Set rapido 1/4 "15 pezzi • [ES] Nozzles kaj magneta posedanto fastas 1/4 "15 komputilojn • [PT] Bicos e suporte magnético fixam 1/4 "15 peças

| pcs | Sizing |
|-----|--|
| 14 | 25mm(L) BIT |
| | <ul style="list-style-type: none"> 3PC SLOTTED: 4, 5, 6 2PC PHILLIPS: PH1, PH2 2PC POZI: PZ1, PZ2 3PC HEX: 3, 4, 5 4PC T10, T15, T20, T30 |
| 1 | ADAPTOR MAGNET QUICK RELEASE |



1/4"
15 PCS. SET

1/4"

Art. No. 158903

EAN: 3800123171703



SCREWDRIVER BITS & MAGNETIC HOLDER QUICK-CHANGE 1/4" 32 PCS. SET

[BG] Накрайници и магнитен държач бърз захват 1/4" 32 бр. к-т RAIDER • [RO] Set biti 32 buc • [SR] Pin Set 32 kom • [MK] Битови, Сет 32 пар • [RU] Набор бит 32 пр • [SL] Set bit-nastavkov 32-delni komplet • [EL] Σет мүтес 32 τεμαχίων σε κασετίνα • [HR] Set bitovi 1/4" 32 kom • [FR] Embouts de tournevis et support magnétique à changement rapide 1/4 "Set de 32 pièces • [IT] Set di cacciaviti e supporto magnetico Set rapido 1/4 "32 pezzi • [ES] Nozzles kaj magneta posedanto fastas 1/4 "32 komputilojn • [PT] Bicos e suporte magnético fixam 1/4 "32 peças

32pcs

| pcs | Sizing |
|-----|---|
| 30 | 25mm(L) BIT |
| | <ul style="list-style-type: none"> 4PCS SLOTTED: 3, 4, 5, 6 4PCS PHILLIPS: PH1, PH2, PH3, PH4 4PCS POZI: PZ1, PZ2, PZ2, PZ3 4PCS HEX: 3, 4, 5, 6mm 7PCS T10, T15, T20, T25, T27, T30, T40 7PCS: T10, T15, T20, T25, T27, T30, T40 |
| 1 | ADAPTOR 25MM FROM 1/4" TO 1/4 SQR. |
| 1 | ADAPTOR MAGNET QUICK RELEASE |



Art. No. 158901

EAN: 3800123171680



ADAPTERS SET 1/4 HEX TO 1/4", 3/8", 1/2" SQUARE 3 PCS.

[BG] Адаптери 3 броя комплект • [RO] Set 3 buc adaptor • [SR] Adapter 3 komada set • [MK] Адаптер 3 парчиња комплет • [RU] Переходник 3 шт набор • [SL] Adapter 3 kosi komplet • [EL] Προσαρμογέας σετ 3 τεμαχίων • [HR] Adapteri 3 komada set • [FR] Kit de 3 adaptateurs • [IT] Adattatori Kit da 3 pezzi • [ES] Adaptilloj 3 pecoj kit • [PT] Kit de 3 peças para adaptadores

1/4 HEX to 1/4", 3/8", 1/2" SQ

Art. No. 158904

EAN: 3800123173486



BLISTER

SCREWDRIVER BITS & MAGNETIC HOLDER QUICK-CHANGE

• [BG] Накрайници и магнитен държач бърз захват 1/4" 42 бр. к-т RAIDER • [RO] Set biti 42 buc • [SR] Pin Set 42 kom • [MK] Битови, Set 42 пар • [RU] Набор бит 42 пр • [SL] Set bit-nastavkov 42-delni komplet • [EL] Σετ μύτες 42 τεμαχίων σε κοστίκινα • [HR] Set bitovi 1/4" 42 kom • [FR] Embouts de tournevis et support magnétique à changement rapide 1/4 "Set de 42 pièces • [IT] Set di cacciaviti e supporto magnetico Set rapido 1/4 "42 pezzi • [ES] Nozzles kaj magnetna posedanto fastas 1/4 " 42 komputilojn • [PT] Bicos e suporte magnético fixam 1/4 "42 peças

| pcs | Sizing |
|-----|---|
| | 25mm(L) BIT |
| 36 | <ul style="list-style-type: none"> ● SLOTTED: 4 X 2PCS, 5, 6 ⊕ PHILLIPS: PH1, PH2, PH3 X 3PCS ⊕ POZI: PZ1, PZ2, PZ3 X 4PCS ⊙ 3PCS HEX: 3, 4, 5 ⊙ 7PCS T10, T15, T20, T25, T27, T30, T40 ⊙ 7PCS: T10, T15, T20, T25, T27, T30, T40 |
| 4 | 75mm BIT: Sl: 6, PH2, Pozi: PZ2, Torx: T25 |
| 1 | ADAPTOR 25MM FROM 1/4" TO 1/4 SQR. |
| 1 | ADAPTOR MAGNET QUICK RELEASE |

1/4" 42 PCS. SET



Art. No. 158902

EAN: 3800123171697

CLAMPING AND WORKING TAB

[BG] Маса работна-менгеме • [RO] Banc de lucru • [SR] Radni sto sklopivi • [MK] Маса работна • [RU] Стол-верстак • [SL] Delovna miza • [EL] Πάγκος εργασίας • [HR] Stezni i radni stol • [FR] Serrage et table de travail • [IT] Morsetto e tavolo di lavoro • [ES] Sujeción y mesa de trabajo. [PT] Fixação e mesa de trabalho

FOLDABLE FOR EASY STORAGE

Art. No. 139905

EAN: 38001231119170



COLOR BOX

Art. No. 139970

EAN: 3800123171758



COLOR BOX

DRILL STAND

• [BG] Стойка за бормашина • [RO] Stativ pentru bormasina • [SR] Postolje za bušilicu • [MK] Држач за дупчалка • [RU] Стенд для дрель • [SL] Stojalo za vrtalnike • [EL] Βάση Δραπάνου • [HR] Stalac za bušilicu • [FR] Support de foret • [IT] Supporto per trapano • [ES] Soporte para taladro • [PT] Suporte para broca



Art. No. 139201

EAN: 3800972004054

DRILL STAND VICE DIE CAST BODY

• [BG] Менгеме машинно • [RO] Menghina pentru bormasina • [SR] Stega za stubnu bušilicu • [MK] Менгеме за бормашина • [RU] Станочные поворотные тиски • [SL] Prímež za namizni vrtalni stroj • [EL] Μεγένη για την βάση • [HR] Stega za Stupna bušilica • [FR] Support pour meuleuse d'angle • [IT] Morsa girevole della macchina • [ES] Soporte para amoladora angular • [PT] Suporte para rebarbadora



L1
75mm

Art. No. 139914
EAN: 3800123119132

L1
100mm

Art. No. 139915
EAN: 3800123119149

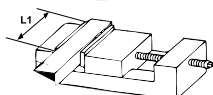

ANGLE GRINDER STAND

[BG] Стойка за ъглошлайф • [RO] Stativ pentru polizor unghiular • [SR] Postolje za brusilica ugaona • [MK] Држач за брусилка • [RU] Стенд для угловой шлифовальная машина • [SL] Stojalo za kotni brusilnik • [EL] Βάση γωνιακός τροχός • [HR] Stalac za kutnu brusilicu • [FR] Support pour meuleuse d'angle • [IT] Supporto per angle grinder • [ES] Soporte para amoladora angular • [PT] Suporte para rebarbadora

Art. No. 139501

EAN: 3800972004061

Art. No. 139912

EAN: 3800123126208

115
mm

125
mm



COLOR BOX

Art. No. 139913

EAN: 3800123126215

230
mm



COLOR BOX

ACCESSORIES FOR MINI GRINDER 100 PCS SET

[BG] Аксесоари за шлифовалка 100 бр. комплект • [RO] Set accesorii ptr. minipolizor -100 buc/set • [SR] Set za dšćenje/poliranje 100 kom • [MK] Set dodatoci za Ramna brusilica со осило 100 ком • [RU] Набор насадок для полировки 100 шт. • [SL] 100-delni komplet za poliranje • [EL] Σετ στίλβωσης 100 τεμ • [HR] Nastavci za brušenje 100 kom • [FR] Accessoires pour Mini Grinder 100 pcs Set • [IT] Accessori per Mini Grinder Set 100 pezzi • [ES] Accesorios para Mini Grinder 100 piezas Set • [PT] Acessórios para Mini Grinder 100 pcs Set

Art. No. 139901
EAN: 3800123124969



FLEXIBLE SHAFT FOR MINI GRINDER

[BG] Жило за шлифовалка • [RO] Arbore flexibil ptr. minipolizor • [SR] Fleksibilna osovina za brusilica • [MK] Флексибилно вратило за брусилка • [RU] Гибкий вал для мини шлифмашина • [SL] Gibljivo gredjo za mini brusilnik • [EL] Εύκαμπτο άξονα για мини τροχάκι • [HR] Fleksibilno vratilo za brusilica • [FR] Arbre flexible pour mini meuleuse • [IT] Albero flessibile per Mini Grinder • [ES] Fleksebla Selo por Mini Muelillo • [PT] Eixo Flexível para Mini Moedor

Art. No. 138403
EAN: 3800123170768



ACCESSORIES FOR MINI GRINDER 249 PCS SET

[BG] Аксесоари за шлифовалка 249 бр. комплект • [RO] Set accesorii ptr. minipolizor - 249 buc/set • [SR] Set za dšćenje/poliranje 249 kom • [MK] Set dodatoci za Ramna brusilica со осило 249 ком • [RU] Набор насадок для полировки 249 шт. • [SL] 249-delni komplet za poliranje • [EL] Σετ στίλβωσης 249 τεμ • [HR] Nastavci za brušenje 249 kom • [FR] Accessoires pour Mini Grinder 100 pcs Set • [IT] Accessori per Mini Grinder Set 100 pezzi • [ES] Accesorios para Mini Grinder 100 piezas Set • [PT] Acessórios para Mini Grinder 100 pcs Set

Art. No. 138402
EAN: 3800123170751



CARBIDE ENGRAVING POINT TIP FOR RD-ENGO 1

[BG] Накрайник карбиден с остър връх • [RO] Freze pantograf proxhon Carbid • [SR] Vrh za graviranje karbidni • [MK] Бит за гравирање карбид • [RU] Карбидная гравировальная насадка • [SL] Bit za graviranje • [EL] Μύτεξ χάρδης καρβιδίου • [HR] Vrh za graviranje karbidni • [FR] Pointe de gravure au carbure • [IT] Punta del punto di incisione in carburo • [ES] Carbide Gravura Punto Tip • [PT] Ponta de gravação de carboneto

Art. No. 138404
EAN: 3800123173028



CARBIDE ENGRAVING FLAT TIP FOR RD-ENGO 1

[BG] Накрайник карбиден с плосък връх • [RO] Freze pantograf proxhon Carbid • [SR] Vrh za graviranje karbidni • [MK] Бит за гравирање карбид • [RU] Карбидная гравировальная насадка • [SL] Bit za graviranje • [EL] Μύτεξ χάρδης καρβιδίου • [HR] Vrh za graviranje karbidni • [FR] Pointe plate de gravure au carbure • [IT] Punta piatta per incisione in carburo • [ES] Carbide Grabado Flat Tip • [PT] Ponta plana de gravação de metal duro

Art. No. 138405
EAN: 3800123173035



DIAMOND BURRS 20 PCS SET

[BG] Борчета диамантени 20 бр. комплект • [RO] Set 20 buc ace pentru slefuit biax • [SR] 20-delni set glodala dijamantski • [MK] Дијамантски уметок сет 20 ком • [RU] Заусенцы диаманта набор 20 шт. • [SL] Rezkari - dijamantni komplet 20 kos • [EL] Σετ Διαμόντια φρέζες 20 τεμ • [HR] Nastavci za brušenje dijamantni 20 kom • [FR] Jeu de 20 fraises diamantées • [IT] Diamond Burrs Set da 20 pezzi • [ES] Diamond Burrs 20 piezas Set • [PT] Diapasão 20 unidades

Art. No. 157709
EAN: 3800123121333

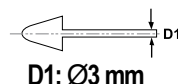

DIAMOND BURRS 30 PCS SET

[BG] Борчета диамантени 30 бр. комплект • [RO] Set 30 buc ace pentru slefuit biax • [SR] 30-delni set glodala dijamantski • [MK] Дијамантски Уметок Сет 30 ком • [RU] Заусенцы диаманта набор 30 шт. • [SL] Rezkari - dijamantni komplet 30 kos • [EL] Σετ Διαμόντια φρέζες 30 τεμ • [HR] Nastavci za brušenje dijamantni 30 kom • [FR] Set de 30 fraises diamantées • [IT] Diamond Burrs Set da 30 pezzi • [ES] Diamond Burrs 30 piezas Set • [PT] Brocas de diamante 30 peças

Art. No. 157708
EAN: 3800123121340

PLASTIC BOX WITH COVER

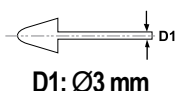

MOUNTED GRINDING POINT 5 PCS SET

[BG] Борчета абразивни • [RO] Set 5 buc pietre slefuit pentru bormasina • [SR] Brusni kamen set 5kom • [MK] Сет абразивен камен 5 ком • [RU] Каменные боры набор 5 шт. • [SL] Brusilni čepi komplet 5 kos • [EL] Σετ Πέτρес τροχισματος από οξείδιο αργιλίου 5 τεμ • [HR] Nastavci za brušenje 5 kom • [FR] Point de meulage monté, 5 pièces • [IT] Set di 5 pezzi per smerigliatrice montata • [ES] Juego de 5 puntos de molinda montada • [PT] Ponto de moagem montado 5 pcs Set

Art. No. 159903
EAN: 3800123121104

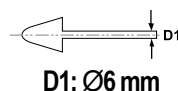

ROTARY RASP FILE 5 PCS SET

[BG] Борчета за дърво • [RO] Set 5 buc raspile pentru slefuit biax • [SR] 5-delni set glodala za drvo • [MK] Уметок за дрво Сет 5 ком • [RU] Заусенцы для древо набор 5 шт. • [SL] Rezkari komplet 5 kos • [EL] Σετ φρέζες 5 τεμ • [HR] Bavettes pour le bois mis 5 pcs • [IT] Bave per legno set 5 pezzi • [ES] Conjunto rebabas para madera 5 uds. • [PT] Rebarbas para madeira set 5 pcs.

Art. No. 159902
EAN: 3800123121319

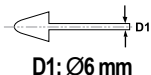

ADAPTER SDS-PLUS TO CHUCK

[BG] Адаптер SDS-plus за патронник • [RO] Adaptor mandrina SDS-PLUS • [SR] Adapter SDS-plus • [MK] Адаптер SDS-plus за пречник • [RU] Переходник для патрона SDS-Plus • [SL] Adapter SDS-plus za vrtalna glava • [EL] Στελεχος υποδοχης sds plus για στοκ • [HR] Adapter stezne glave • [FR] Adapteur SDS-plus au mandrin • [IT] Adattatore SDS-plus a Chuck • [ES] Adaptador SDS-plus a Chuck • [PT] Adaptador SDS-plus para Chuck

Art. No. 159901
EAN: 3800123125607

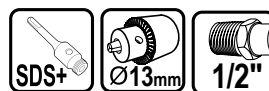

DRILL CHUCK KEYLESS 2 PLASTIC SLEEVE

[BG] Патронник за бормашина самозатягащ пластм. • [RO] Mandrina rapida • [SR] Stezna glava plast. brzostežuca • [MK] Стезна глава [RU] Патрон дря дрели без ключа • [SL] Vrtna glava samozatezna • [EL] Τοοκ δρσπστυου αυτόματο • [HR] Brzostezna glava • [FR] Mandrin de perçage sans clé • [IT] Mandrino autoserrante • [ES] Boru bastanon • [PT] Mandril de brocas sem chave

FOR RD-KC01

Art. No. 139906
EAN: 3800123123931

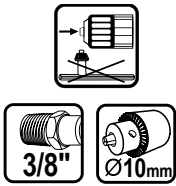

+ ADAPTER 1/4"

Art. No. 139003
EAN: 3800123163814

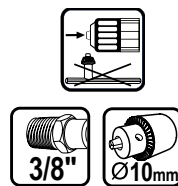

Art. No. 139908
EAN: 3800123139488

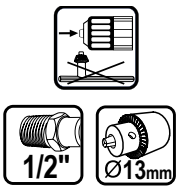

SLEEVE PLASTIC, REAR SLEEVE METAL

Art. No. 139943
EAN: 3800123150203

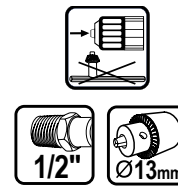

METAL SLEEVE WITH CLICK FOR RD-KC11

Art. No. 139942
EAN: 3800123149870

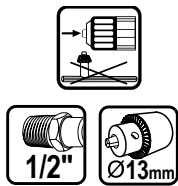

CHUCK KEY FOR DRILL CHUCK

[BG] Ключ за патронник на бормашина • [RO] Cheie mandrina • [SR] Ključ za steznu glavu bušilice • [MK] Ключ за стезна глава • [RU] Ключ для патрона • [SL] Ključ za vrtna glava • [EL] Κλειδί για τοοκ • [HR] Ključ za Stezna glava • [FR] Clé de mandrin pour mandrin • [IT] Chiave per mandrino • [ES] Llave de sujeción de tornillo • [PT] Chave de aperto de parafuso

| art. № | for model | ∅ (mm) | BARCODE |
|--------|-----------|--------|---------------|
| 139903 | RD-KC08 | 13 | 3800123126260 |
| 139904 | RD-KC15 | 16 | 3800972014329 |



DRILL CHUCK WITH KEY

[BG] Патронник за бормашина с ключ • [RO] Mandrina cu cheie • [SR] Stezna glava • [MK] Стезна глава со ключ • [RU] Патрон дря дрели с ключа • [SL] Vrtna glava • [EL] Τοοκ δρσπστυου με κλειδί • [HR] Stezna glava s ključem • [FR] Mandrin de perçage avec clé • [IT] Stesna Head con Kluch • [ES] Triluču Chuck kun Ślosilo • [PT] Capitulo Stesna com

| art. № | for model | ∅ (mm) | BARCODE |
|--------|-----------|--------|---------------|
| 139001 | RD-KC13 | 16 | 3800123162138 |
| 139002 | RD-KC14 | 13 | 3800123162862 |
| 139907 | RD-KC03 | 13 | 3800123126253 |



+SDS-PLUS CHUCK ADAPTER KIT

Art. No. 999902
EAN: 3800123123627

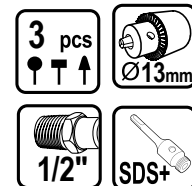

DRILL CHUCK CONE WITH KEY

| art. № | for model | ∅ (mm) | B | BARCODE |
|--------|-----------|--------|----|---------------|
| 139921 | RD-KC04 | 13 | 16 | 3800123124792 |
| 139922 | RD-KC05 | 16 | 16 | 3800123124808 |
| 139925 | RD-KC06 | 20 | 22 | 3800123124730 |



DRILL CHUCK 13MM QUICK CHANGE FOR RDP-CDL21

Art. No. 139006
EAN: 3800972014572



ECCENTRIC ADAPTOR QUICK CHANGE FOR RDP-CDL21

Art. No. 139007
EAN: 3800972015173



ANGLE ADAPTOR QUICK CHANGE FOR RDP-CDL21

Art. No. 139005
EAN: 3800972014565



PAINT MIXER HEX

[BG] Бъркалка за боя • [RO] Mixer vopsea • [SR] Mešač • [MK] Мешалка за боја • [RU] Миксер для краски металлический • [SL] Barve mešalnikom • [EL] Αναδευτήρας χρωμάτων • [HR] Mješač • [FR] Mélangeur de peinture • [IT] Miscelatore di vernice • [ES] Mezclador de pintura • [PT] Misturador de tinta

| art. № | D1 (mm) | D2 (mm) | D3 (mm) | BARCODE |
|--------|---------|---------|---------|---------------|
| 329901 | Ø80 | 400 | 8 HEX | 3800123126239 |
| 329902 | Ø100 | 600 | 10 HEX | 3800123126246 |

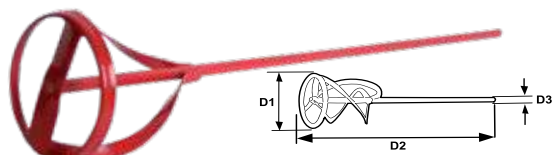

MIXING PADDLE

[BG] Бъркалка • [RO] Mixer vopsea • [SR] Mešač • [MK] Мешалка • [RU] Миксер металлический • [SL] Mešalnikom • [EL] Αναδευτήρας • [HR] Mješač • [FR] Mélangeur • [IT] Pagaia • [ES] Mezclador • [PT] Mixer

| art. № | D1 (mm) | D2 (mm) | D3 (mm) | BARCODE |
|--------|---------|---------|---------|---------------|
| 329925 | Ø80 | 400 | 8 HEX | 3800123127793 |
| 329926 | Ø100 | 600 | 10 HEX | 3800123127809 |

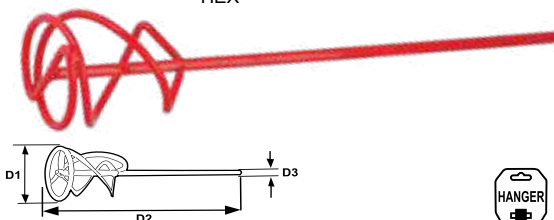

MIXING PADDLE

[BG] Бъркалка • [RO] Mixer vopsea • [SR] Mešač • [MK] Мешалка • [RU] Миксер металлический • [SL] Mešalnikom • [EL] Αναδευτήρας • [HR] Mješač • [FR] Pagaie de mélange avec spirale plate [IT] Paletta di miscelazione con spirale piatta • [ES] Paleta Mezcladora • [PT] Misturando paddle

MIXING PADDLE WITH FLAT SPIRAL

| art. № | D1 (mm) | D2 (mm) | D3 (mm) | BARCODE |
|--------|---------|---------|---------|---------------|
| 329927 | Ø100 | 600 | 10 HEX | 3800123127816 |
| 329928 | Ø120 | 600 | 10 HEX | 3800123127823 |

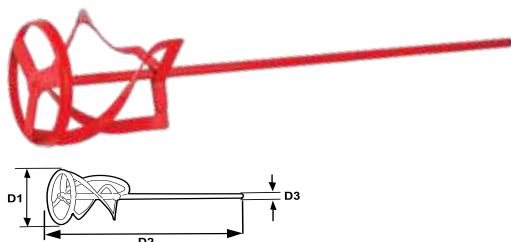

MIXING PADDLE SDS-PLUS

| art. № | D1 (mm) | D2 (mm) | D3 (mm) | BARCODE |
|--------|---------|---------|---------|---------------|
| 329935 | Ø80 | 400 | 10 SDS+ | 3800123151224 |
| 329936 | Ø100 | 600 | 10 SDS+ | 3800123151231 |

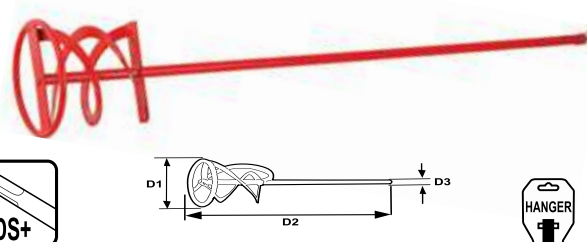

MIXING PADDLE FOR POWER MIXER

| art. № | D1 (mm) | D2 (mm) | D3 (mm) | BARCODE |
|--------|---------|---------|---------|---------------|
| 329924 | Ø120 | 600 | M14 | 3800123127786 |

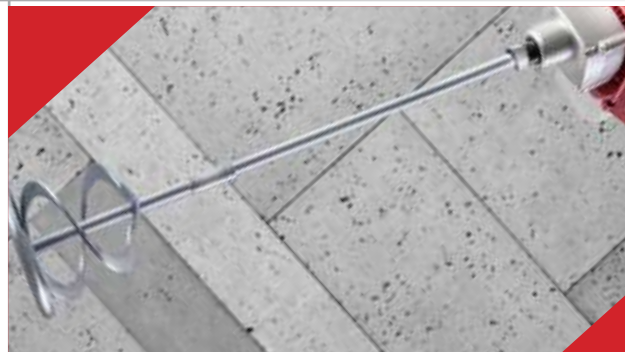
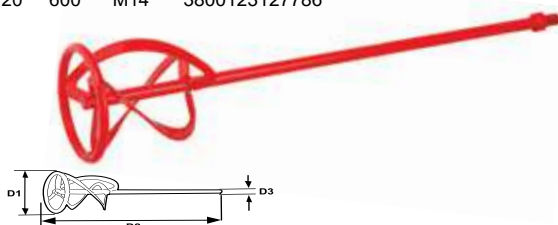

MIXING PADDLE ZINC PLATED

[BG] Бъркалка цинкувана за боя • [RO] Mixer zincat pentru vopsea • [SR] Mešač pocinkovan za boja • [MK] Мешалка цинкувана за боја • [RU] Миксер металлический • [SL] Mešalnikom pocinkana • [EL] Αναδευτήρας γαλβανιζέ • [HR] Mješač pocinčane za boja • [FR] Mélangeur galvanisé pour peinture • [IT] Miscelatore zincato per vernice • [ES] Mezclador galvanizado para pintura • [PT] Mezclador galvanizado para pintura

MIXING PADDLE ZINC PLATED HEX

| art. № | D1 (mm) | D2 (mm) | D3 (mm) | BARCODE |
|--------|---------|---------|---------|---------------|
| 138501 | Ø80 | 400 | 8 HEX | 3800123166297 |
| 138502 | Ø80 | 400 | 8 HEX | 3800123166303 |
| 138503 | Ø100 | 600 | 10 HEX | 3800123166310 |

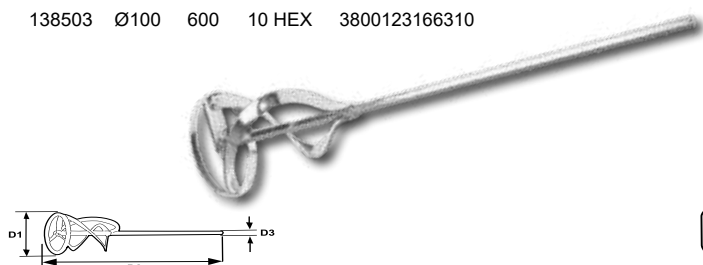

MIXING PADDLE SDS-PLUS ZINC PLATED

| art. № | D1 (mm) | D2 (mm) | D3 (mm) | BARCODE |
|--------|---------|---------|---------|---------------|
| 138504 | Ø80 | 400 | SDS+ | 3800123166327 |
| 138505 | Ø100 | 600 | SDS+ | 3800123166334 |

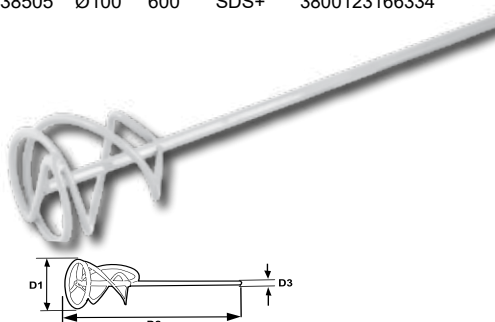

MIXING PADDLE FOR ELECTRIC POWER MIXER

[BG] Бъркалка поцинкована за електрически миксер • [RO] Mixer zincat • [SR] Mešač pocinkovan • [MK] Мешалка поцинкована • [RU] Миксер металлический • [SL] Mešalnik pocinkana • [EL] Ανοδευτράς γαλβανιζέ • [HR] Mješač pocinčane • [FR] Mélangeur zingué électrique • [IT] Miscelatore zincato elettrico • [ES] Mezclador chapado en zinc eléctrica • [PT] Misturador zincado eléctrica

MIXING PADDLE FOR ELECTRIC POWER MIXER ZINC PLATED

| art. № | D1 (mm) | D2 (mm) | D3 (mm) | BARCODE |
|--------|---------|---------|---------|---------------|
| 138506 | Ø120 | 600 | M14 | 3800123166341 |

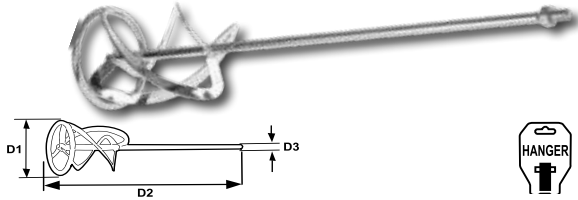

MIXING PADDLE FOR ELECTRIC POWER MIXER WITH 2 PADDLES ZINC PLATED

| art. № | D1 (mm) | D2 (mm) | D3 (mm) | BARCODE |
|--------|---------|---------|---------|---------------|
| 138507 | Ø125 | 600 | 13 HEX | 3800972012615 |

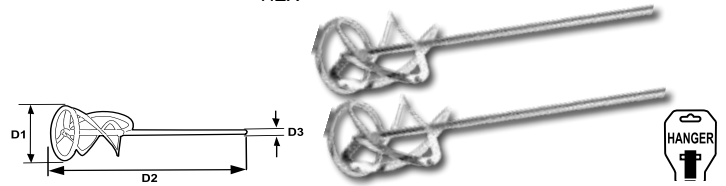

RUBBER BACKING DISK FOR ANGLE GRINDER

[BG] Диск гумен за ъглошлайф • [RO] Suport circular cauciuc • [SR] Nosač brusnog papira gumeni • [MK] Гумен диск за абразивна хартија за брусилка • [RU] Резиновый диск для угловая шлифовальная машина • [SL] Podložak fiber gumena za kotni brusilnik • [EL] Μαξιλάρι δρασπάνου λαστιχένιο • [HR] Gumena ploča za Kutna brusilica • [FR] Caoutchouc à disque pour meuleuse d'angle • [IT] Disco in gomma per smerigliatrice angolare • [ES] Disco de goma para amoladora angular • [PT] Borracha de disco para rebarbadora

Ø 180mm

Art. No. 139920
EAN: 3800123135781

FOR ANGLE GRINDER

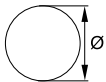

RUBBER BACKING DISK VELCRO UNIVERSAL

[BG] Диск VELCRO универсален • [RO] Suport din cauciuc disc VELCRO universal • [SR] Nosač Disk VELCRO univerzalan • [MK] Гумена диск VELCRO универзална • [RU] Резиновый диск VELCRO универсальный • [SL] Gumijasta podlogka disk VELCRO • [EL] Υποστηρικτικός δίσκος από καουτσούκ δίσκο VELCRO Παγκόσμιος • [HR] Gumena podloga Disk VELCRO univerzalana • [FR] Disque support en caoutchouc VELCRO universal • [IT] Supporto in gomma Disco VELCRO universale • [ES] Kaūča apogilo Disko VELCRO universal • [PT] Disco protetor de borracha VELCRO universal

VELCRO

| art. № | Ø (mm) | BARCODE |
|--------|--------|---------------|
| 139971 | Ø115 | 3800972002241 |
| 139972 | Ø125 | 3800972002258 |



RUBBER BACKING DISK VELCRO FOR ANGLE GRINDER

[BG] Диск гумен за ъглошлайф VELCRO • [RO] Suport circular cauciuc VELCRO • [SR] Nosač brusnog papira gumeni VELCRO • [MK] Гумен диск за абразивна хартија за брусилка • [RU] Резиновый диск для угловая шлифовальная машина • [SL] Podložak fiber gumena za kotni brusilnik • [EL] Μαξιλάρι δρασπάνου λαστιχένιο • [HR] Gumena ploča za Kutna brusilica • [FR] Disque de support en caoutchouc VELCRO pour meuleuse d'angle • [IT] Disco in gomma VELCRO per smerigliatrice angolare • [ES] Kaūča apogo Disk VELCRO por angula muellilo • [PT] Disco de apoio de borracha VELCRO para rebarbadora

Ø 180mm

Art. No. 139924
EAN: 3800123126062

FOR ANGLE GRINDER

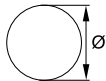

VELCRO



LAMBSWOOL POLISHING BONNET FOR POLISHER

[BG] Кече за полирмашина • [RO] Rezerva polisat • [SR] Navlaka za poliranje jagnjeće vune • [MK] Волнен пад за полирка • [RU] Круг полировальный (натуральная овчина) на липучке • [SL] Krzno za poliranje spužvasto • [EL] Μάλλινος σκούρος για στιλβωτές • [HR] Vuneni jastučić • [FR] Bonnet de polissage en laine d'agneau pour polisseuse • [IT] Cappellino per lucidatura Lambswool per lucidatrice • [ES] Lambswool poluranta tuneton por polisher • [PT] Boné de polimento de lã de cordeiro para polidor

| art. № | Ø (mm) | BARCODE |
|--------|--------|---------------|
| 209934 | 125 | 3800123150692 |
| 209935 | 180 | 3800123150708 |
| 209914 | 240 | 3800123107313 |

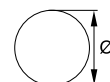

POLISHING KIT DISC VELCRO, LAMBSWOOL POLISHING BONNET, SPONGE

[BG] К-т за пастиране блокче, кече, гъба • [RO] 3Pcs/s Set polizare • [SR] Set za poliranje 3 kom • [MK] Сет за полирање 3 бројот • [RU] Набор насадок для полировки 3 шт. • [SL] 3-delni komplet za poliranje • [EL] Σετ στιλβωσης 3 τεμ • [HR] Vuneni jastučić, Spužvasti jastučić, Brusni disk • [FR] Kit de polissage disque, Bonnet de polissage en laine d'agneau, Eponge • [IT] Disco per lucidatura V, cuffia per lucidatura in lana d'agnello, spugna • [ES] Poluranta kitran diskon, Lambswool Poluranta Bonneton, Spongon • [PT] Kit de polimento disc, boné de polimento lambswool, esponja

Art. No. 499976
EAN: 3800123150715

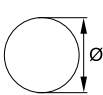

POLISHING SPONGE

[BG] Гъба за полиране • [RO] Buretele de lustruit • [SR] Spužva za poliranje • [MK] Полирање сунѓер • [RU] Полировка губки • [SL] Gobica za poliranje • [EL] Σφουγγάρι στιλβωσης • [HR] Spužva za poliranje • [FR] Éponge à polir • [IT] Spugna per lucidare • [ES] Polura spongo • [PT] Esponja de polimento

Art. No. 155801
EAN: 3800972016620

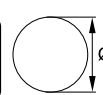

NEW PRODUCT



FLAT TAPERED SCYTHE STONE GREY

[BG] Брус овален сив • [RO] Piara pentru ascutit coasa • [SR] Kamen za oštrenje • [MK] Камен за острене на коса • [RU] Точильный камень • [SL] Brus za ostrenje • [EL] Πέτρα Ακονίσματος • [HR] Brusni kamen • [FR] Scythe plate, gris pierre • [IT] Pietra squadrata affusolata grigia • [ES] Ebena Blanca Štono • [PT] Cinza de pedra afilado liso da foice

Art. No. 499961
EAN: 3800123136412

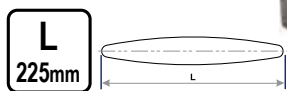

COMBINATION SHAPE STONE WHITE & GREY

[BG] Брус комбиниран бяло и сиво • [RO] Piatra dreptunghiulara pentru ascutit cutite • [SR] Kamen za oštrenje kompozitni • [MK] Брусен камен комбиниран • [RU] Точильный камень составной • [SL] Brus za ostrenje kompozitni • [EL] Πέτρα ακονίσματος σύνθετος • [HR] Brusni kamen • [FR] Combinaison forme pierre blanche et grise • [IT] Combinazione di forma pietra bianca e grigia • [ES] Kombina forma štono blanka kaj griza • [PT] Combinação em forma de pedra branca e cinza

200x50x25mm

Art. No. 499958
EAN: 3800123136382



COMBINATION SHAPE STONE PINK & GREY

[BG] Брус комбиниран розово и сиво • [RO] Piatra dreptunghiulara pentru ascutit cutite • [SR] Kamen za oštrenje kompozitni • [MK] Брусен камен комбиниран • [RU] Точильный камень составной • [SL] Brus za ostrenje kompozitni • [EL] Πέτρα ακονίσματος σύνθετος • [HR] Brusni kamen • [FR] Combination forme pierre rose & gris • [IT] Combinazione shape stone pink & grey • [ES] Kombina shape stone rozkolora & griza • [PT] Combinação forma pedra rosa e cinza

200x50x25mm

Art. No. 499959
EAN: 3800123136399

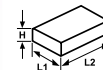

GRINDING WHEEL

[BG] Диск за шмиргел • [RO] Piatra ptr polizor • [SR] Brusni kamen • [MK] Брусни камен бел • [RU] Круг шлифовальный • [SL] Brusilni kamen • [EL] Πέτρα λείανσης (χοντρή) • [HR] Brusna ploča za dvostruke brusilice • [FR] Meule blanche • [IT] Moia bianca • [ES] Muelanta Radon Blanca • [PT] Rebolo branco

GRINDING WHEEL WHITE

| art. № | ∅ (mm) | D1 (mm) | D2 (mm) | P | BARCODE |
|--------|--------|---------|---------|-----|---------------|
| 165121 | 200 | 16 | 20 | P60 | 3800123127533 |

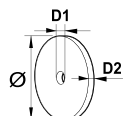

GRINDING WHEEL GREY

| art. № | ∅ (mm) | D1 (mm) | D2 (mm) | P | BARCODE |
|--------|--------|---------|---------|-----|---------------|
| 165119 | 150 | 13 | 16 | P36 | 3800123127519 |
| 165120 | 150 | 13 | 16 | P80 | 3800123127526 |
| 165123 | 200 | 16 | 20 | P60 | 3800123127557 |
| 165124 | 200 | 20 | 40 | P60 | 3800123127564 |

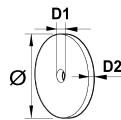

GRINDING WHEEL GREEN

| art. № | ∅ (mm) | D1 (mm) | D2 (mm) | P | BARCODE |
|--------|--------|---------|---------|-----|---------------|
| 165122 | 200 | 16 | 20 | P60 | 3800123127540 |

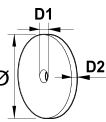

GRINDING WHEEL RED

| art. № | ∅ (mm) | D1 (mm) | D2 (mm) | G | BARCODE |
|--------|--------|---------|---------|------|---------------|
| 165126 | 75 | 10 | 20 | G120 | 3800123171840 |

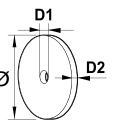

POLISHING WHEEL

| art. № | ∅ (mm) | D1 (mm) | D2 (mm) | PVE | BARCODE |
|--------|--------|---------|---------|-----|---------------|
| 165127 | 75 | 10 | 20 | 400 | 3800123171857 |



DISC FOR CHAIN SAW SHARPENER

| art. № | ∅ (mm) | D1 (mm) | D2 (mm) | BARCODE |
|--------|--------|---------|---------|---------------|
| 140109 | 100 | 10 | 3.2 | 3800123163227 |

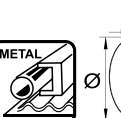

HAND SANDER

[BG] Шлайф ръчен • [RO] Suport smirghel • [SR] Nosač brusnog papira • [MK] Држач за шмиргла • [RU] Блок для ручного шлифования • [SL] Ročno brusilni blok • [EL] Μπλοκ για λείανσης • [HR] Ručna brusilica • [FR] Ponceuse à main • [IT] Mano levigatrice • [ES] Mueillo manlibro • [PT] Manual do moedor

| art. № | D1 (mm) | D2 (mm) | BARCODE |
|--------|---------|---------|---------------|
| 499986 | 85 | 160 | 3800123157059 |
| 499902 | 100 | 210 | 3800123135095 |



HAND SANDER WITH HANDLE

Art. No. 499901
EAN: 3800123135101



SOLDER WIRE

[BG] Тинол • [RO] Fluxdor • [SR] Žica za lemljenje • [MK] Жица за лемење • [RU] Проволочного припоя • [SL] Spajkalna žica • [EL] Κολληση • [HR] Tinol zica za lemljenje • [FR] Fil de soudure • [IT] Filo di saldatura • [ES] Drato de soldvilo • [PT] Fio de solda

60%Sn 40%Pb

| art. № | D1 (mm) | weight (g) | BARCODE |
|--------|---------|------------|---------------|
| 209924 | 1 | 200 | 3800123153518 |
| 209925 | 1.6 | 200 | 3800123153525 |



GLUE STICKS FOR GLUE GUNS

[BG] Силиконови пръчки прозрачни • [RO] Batoane silicon transparente • [SR] Topivi lepak Transparentni • [MK] Стапче за лемење • [RU] Набор стержней для клей-пистолета прозрачный • [SL] Lepilne palice, prozorne • [EL] Ράβδοι κόλλας διαφανής • [HR] Silikonski štapići • [FR] Bâtons de silicone transparents • [IT] Bastoncini di silicone trasparente • [ES] Silikaj bastonaj travideblaj • [PT] Varas de silicone transparentes

GLUE STICKS FOR GLUE GUNS TRANSPARENT

| art. № | D1 (mm) | L1 (mm) | weight (g) | BARCODE |
|--------|---------|---------|------------|---------------|
| 156701 | 7 | 200 | 8 pcs | 3800123162251 |
| 156702 | 7 | 200 | 1000g | 3800123162268 |
| 209909 | 11 | 300 | 1000g | 3800123122354 |
| 209910 | 11 | 300 | 6 pcs | 3800123122200 |



GLUE STICKS FOR GLUE GUNS BLACK

| art. № | D1 (mm) | L1 (mm) | weight (g) | BARCODE |
|--------|---------|---------|------------|---------------|
| 156703 | 7 | 200 | 8 pcs | 3800123162275 |
| 156704 | 11 | 200 | 6 pcs | 3800123162282 |
| 156705 | 11 | 300 | 1000g | 3800123163357 |

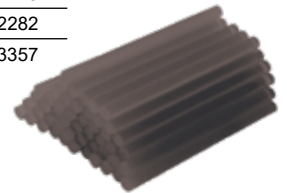

SOCKET FOR PP PIPE WELDING

[BG] Глава за поялник за PP тръби • [RO] Matrita pt lipit tevi PPR • [SR] Nastavak za peglu za plastične cevi • [MK] Продолжение на Електричен заварувач за пластични цевки • [RU] Насадка для полипропиленовых труб • [SL] Nastavka za Varilnik za PP-R cevi • [EL] Καλούπια για Μηχανημα συγκόλλησης πλαστικών • [HR] Nastavak za varenje PPR-a • [FR] Douille pour soudage de tubes en PP • [IT] Presa per saldatura tubi in PP • [ES] Socket por PP-tubo-soldado • [PT] Soquete para soldagem de tubos PP

| art. № | Ø (mm) | BARCODE |
|--------|--------|---------------|
| 123108 | 20 | 3800123151156 |
| 123109 | 25 | 3800123151163 |
| 123110 | 32 | 3800123151170 |
| 123111 | 40 | 3800123151187 |



ELECTRODE HOLDER

[BG] Ръкохватка за заваряване с електроди • [RO] Cleste electrozi sudura • [SR] Držac elektrode • [MK] Држач за заварување • [RU] Держатель электродов • [SL] Elektro varilni ročaji • [EL] Τσιμπιδά ηλεκτροδίου • [HR] Držac elektrode za zavarivanje sa oprugom • [FR] Porte-électrode • [IT] Portaelettrodo • [ES] Electrodo-posedanto • [PT] Suporte do eletrodo

| art. № | A | BARCODE |
|--------|-----|---------------|
| 499923 | 300 | 3800123104138 |
| 499924 | 500 | 3800123104121 |



EARTH CLAMP

[BG] Щипка за маса за електрожен • [RO] Cleste prindere ptr impantantare • [SR] Klešta za uzemljenje • [MK] Клешта за заземлување • [RU] Зажим для заземления • [SL] Klešče za maso • [EL] Συμπα ηλεκτροσυγκόλλησης • [HR] Klješti za masu • [FR] Pince de terre • [IT] Morsetto di terra • [ES] Trancajo de tero • [PT] Braçadeira da terra

Art. No. 499930
EAN: 3800123104145

500
A



ARROW MAGNET WELDING HOLDER

[BG] Магнитен ъгъл държач • [RO] Suport magnetic pentru sudura in unghi • [SR] Stezač magnetskog • [MK] Магнетн ъгъл държач • [RU] Магнитный держатель углов • [SL] Nosilec magnetnega kota • [EL] Μαγνητική γωνιακή βάση • [HR] Stezač magnetskog • [FR] Titulaire d'angle magnétique • [IT] Supporto magnetico per saldatura a freccia • [ES] Magneta angula holder • [PT] Suporte de ângulo magnético

| art. № | Size (mm) | Grade 0 | Weight (kg) | BARCODE |
|--------|--------------|--------------------------------|-------------|---------------|
| 138340 | 120x80x14mm | 45° 90° 135° | 11 | 3800972009752 |
| 138341 | 155x102x16mm | 45° 90° 135° | 22 | 3800972009769 |
| 138342 | 155x76mm | 165° 60° 90° 135° 120° 15° 45° | 11 | 3800972009776 |



Art. No. 130340



Art. No. 130341



Art. No. 130342

NEW
PRODUCT





SAW CHAIN

[BG] Верига за резачка • [RO] Lanț pentru ferestrau • [SR] Lanac za lančanu testeru • [MK] Ланец за моторна пила • [RU] Цепь пила • [SL] Veriga za žago • [EL] Αλυσίδα • [HR] Lanac za pila • [FR] Chaîne de scie • [IT] Ha visto la catena • [ES] Vidita Čeno • [PT] Corrente de serra





SAW CHAIN FOR GASOLINE CHAIN SAW

| art. № |  |  |  | BARCODE |
|---------------------------------------|---|---|---|---------------|
| 140116 for RDGCS18 | 3/8" | .050" (1.3mm) | 45 | 3800123174513 |
| 140117 for RD-GCS18 | 3/8" | .050" (1.3mm) | 40 | 3800123174650 |
| 140120 for RD-GCS22 | .325" | .058" (1.5mm) | 60 | 3800972014343 |
| 140105 | .325" | .050" (1.3mm) | 64 | 3800123162381 |
| 140119 RD-GCS13&14 | .325" | .058" (1.5mm) | 64 | 3800972004153 |
| 140106 | .325" | .050" (1.3mm) | 72 | 3800123162398 |
| 140107 for RD-GCS15,19,20,07,08,21 | .325" | .058" (1.5mm) | 72 | 3800123162404 |
| 140122 for RDP-GCS23 | .325" | .058" (1.5mm) | 86 | 3800972015593 |



COLOR BOX

SAW CHAIN FOR ELECTRIC CHAIN SAW

| art. № |  |  |  | BARCODE |
|--------------------------------------|---|---|---|---------------|
| 140101 | 3/8" | .050" (1.3mm) | 50 | 3800123162343 |
| 140102 for RD-ECS16X, SBCS20 | 3/8" | .050" (1.3mm) | 52 | 3800123162350 |
| 140103 | 3/8" | .050" (1.3mm) | 56 | 3800123162367 |
| 140104 for RD-ECS17X,18X,19,20,12 | 3/8" | .050" (1.3mm) | 57 | 3800123162374 |
| 140121 for RD-ECS25 | 3/8" | .050" (1.3mm) | 62 | 3800972015586 |







COLOR BOX

GUIDE BAR

[BG] Водач за верига за резачка • [RO] Lama ghidaj pentru drujba • [SR] Vodič lanca za motornu pilu • [MK] Водич за ланец за моторна пила • [RU] Направляющая шина для цепь бензопилы • [SL] Meč za veriga za motorno žago • [EL] Λαμα για αλυστοπριονα • [HR] Vodičica za lanac • [FR] Barre guide • [IT] Barra guida • [ES] Gvidilo trinkejo • [PT] Barra guia







| art. № |  |  |  |  | BARCODE |
|---------------------------------------|---|---|---|---|---------------|
| 141306 for RD-GCS18 | 12" 305mm | | 0.050"(1.3mm) | 45 | 3800123174551 |
| 141308 for RD-GCS18 | 10" 255mm | 3.8" | 0.050"(1.3mm) | 40 | 3800123174643 |
| 141307 for RD-ECS14 | 14" 355mm | 3.8" | 0.050"(1.3mm) | 52 | 3800123174568 |
| 141311 for RD-GCS22 | 14" 355mm | 0.325" | 0.058"(1.5mm) | 52 | 3800972014350 |
| 141301 for RD-ECS17X | 16" 400mm | 3.8" | 0.050"(1.3mm) | 57 | 3800123162718 |
| 141312 for RD-ECS25 | 18" 450mm | 3.8" | 0.050"(1.3mm) | 62 | 3800972015609 |
| 141309 for RD-GCS13,14 | 16" 400mm | 0.325" | 0.058"(1.5mm) | 64 | 3800972002333 |
| 139964 for RD-GCS15,19,20,07,08,21 | 18" 450mm | 0.325" | 0.058"(1.5mm) | 72 | 3800123139956 |
| 141313 for RD-GCS23 | 22" 550mm | 0.325" | 0.058"(1.5mm) | 86 | 3800972015616 |



COLOR BOX



GUIDE BAR OREGON

| art. № |  |  |  |  | BARCODE |
|-------------------------------|--|---|---|---|---------------|
| 141314 for RDP-SBCS20 | 14" 350mm | 3/8" | 0.050"(1.3mm) | 52 | 3800972015647 |
| 141305 for RD-ECS18X,19,20 | 16" 400mm | 3/8" | 0.050"(1.3mm) | 57 | 3800123174506 |



COLOR BOX



GREASE GUN WITH GREASE FOR CHAIN SAW

[BG] Такаламит с грес за верижен трион • [RO] Pistol gresare pentru fierastrau cu lant • [SR] Mazalica sa mast za motorna testera • [MK] Мазалица рачна декаламитна за моторна пила • [RU] Шприц для смазки для цепные пилы • [SL] Mazalica za motornih žag • [EL] Γρασαδόρος για βενζινοκίνητο αλυστρίο • [HR] Mazalica za motorna pila • [FR] Pistolet graisseur avec graisse pour scie à chaîne • [IT] Ingrassare la pistola con grasso per motosega • [ES] Armilo pafilo kun graso por čeno • [PT] Pistola de graxa com graxa para motosserra

Art. No. 141304

EAN: 3800123167423



FILE FILING GUIDE KIT FOR CHAIN SAW

[BG] Пила с водич комплект за верижен трион • [RO] Kit ascutire lant • [SR] Turpija za lančanu testeru sa vodič set • [MK] Турпија за ланец за моторна пила со водич • [RU] Набор для заточки цепей - напильник и шаблон • [SL] Držalo pile in okrogla pila • [EL] Βάση λίμας με στρογγυλή λίμα • [HR] Držač turpije (uklj. turpija) • [FR] Trousse de guide de classement pour scie à chaîne • [IT] Kit di guida per la limatura dei file per motosega • [ES] Dosiera ficha gvidilo por čeno • [PT] Kit de guia de arquivamento de arquivo para motosserra

art. №



BARCODE

140112 for electric chain saw 3/8" 4mm 3800123167430

140113 for gasoline chain saw .325" 4.8mm 3800123167447



POLISHING GALVANIZED LOG SAW TRESTLE

[BG] Стойка за рязане на дърва • [RO] Suport capra pentru taiat lemne • [SR] Metalni stalak za piljenje • [MK] Држач за сечење на дрва • [RU] Подставка для резания древесины • [SL] Koza za žaganje drv • [EL] Καβαλέτο Κοπής Ξύλων • [HR] Metalni stalak za piljenje • [FR] Tréteau de scie à grumes galvanisé • [IT] Tronchetto per seghe a filo zincato lucidato • [ES] Poluranta galvanan en saluton rigardis • [PT] Cavalete de serra galvanizado de polimento

Art. No. 140118

EAN: 3800123174704



TRIMMER LINE

[BG] Корда за косачка тример • [RO] Fir rezerva trimmer • [SR] Najlon za trimer • [MK] Конеч за косилка • [RU] Леска для триммера • [SL] Najlonska nitka za obrezovalnik trave • [EL] Μεισινέζα στρογγυλή • [HR] Najlonska nit Okrugla • [FR] Ligne de coupe pour coupe-herbe ronde • [IT] Trimmer per tosaerba rotondo • [ES] Trimmer-linio por herba trimmer • [PT] Aparador para aparador de grama

TRIMMER LINE FOR GRASS TRIMMER ROUND

| art. № | D1 (mm) | L1 (m) | BARCODE |
|--------|---------|--------|---------------|
| 110208 | 1.3 | 15 | 3800123151811 |
| 110210 | 1.65 | 15 | 3800123151859 |
| 110204 | 2.40 | 15 | 3800123141706 |

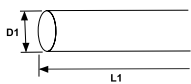

FORCE STRING TRIMMER LINE FOR BRUSH CUTTERS ROUND

| art. № | D1 (mm) | L1 (m) | BARCODE |
|--------|---------|--------|---------------|
| 110236 | 2.4 | 260 | 3800123167416 |

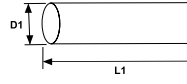

TRIMMER LINE FOR BRUSH CUTTERS ROUND

| art. № | D1 (mm) | L1 (m) | BARCODE |
|--------|---------|--------|---------------|
| 110227 | 3.0 | 15 | 3800123166372 |

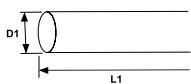

TRIMMER LINE SQUARE

| art. № | D1 (mm) | L1 (m) | BARCODE |
|--------|---------|--------|---------------|
| 110226 | 3.0 | 15 | 3800123166365 |

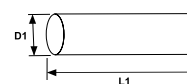

TRIMMER LINE FOR GRASS TRIMMER SQUARE

| art. № | D1 (mm) | L1 (m) | BARCODE |
|--------|---------|--------|---------------|
| 110209 | 1.3 | 15 | 3800123151828 |
| 110211 | 1.65 | 15 | 3800123151835 |
| 110212 | 2.40 | 15 | 3800123151842 |

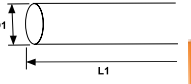

FORCE STRING TRIMMER LINE FOR BRUSH CUTTERS SQUARE

| art. № | D1 (mm) | L1 (m) | BARCODE |
|--------|---------|--------|---------------|
| 110280 | 1.65 | 15 | 3800972003880 |
| 110281 | 2.00 | 15 | 3800972003897 |

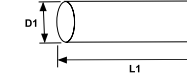

TRIMMER LINE

[BG] Корда за косачка тример • [RO] Fir rezerva trimmer • [SR] Najlon za trimer • [MK] Конец за косилка • [RU] Леска для триммера • [SL] Najlonska nitka za obrezovalnik trave • [EL] Μερίνιζα στρουγγυλή • [HR] Najlonska nit Okrugla • [FR] Ligne de coupe pour coupe-herbe ronde • [IT] Trimmer per tosaerba rotondo • [ES] Trimmer-linio por herba trimmer • [PT] Aparador para aparador de grama

FORCE STRING TRIMMER LINE FOR BRUSH CUTTERS SQUARE

| art. № | D1 (mm) | L1 (m) | BARCODE |
|--------|---------|--------|---------------|
| 110235 | 2.4 | 15 | 3800123167409 |

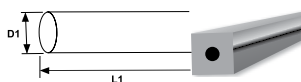

FORCE STRING TRIMMER LINE FOR BRUSH CUTTERS SQUARE PLATIN SILVER

| art. № | D1 (mm) | L1 (m) | BARCODE |
|--------|---------|--------|---------------|
| 110290 | 2.7 | 15 | 3800972015807 |
| 110291 | 3.0 | 12 | 3800972015814 |

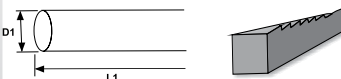

FORCE STRING TRIMMER LINE FOR BRUSH CUTTERS SQUARE

| art. № | D1 (mm) | L1 (m) | BARCODE |
|--------|---------|--------|---------------|
| 110282 | 3.0 | 12 | 3800972003903 |
| 110283 | 3.5 | 8 | 3800972003910 |
| 110285 | 4.0 | 6 | 3800972004269 |
| 110286 | 4.5 | 5 | 3800972004276 |



TRIMMER LINE FOR GRASS TRIMMER TWISTED

| art. № | D1 (mm) | L1 (m) | BARCODE |
|--------|---------|--------|---------------|
| 110248 | 3.0 | 28 | 3800123172090 |
| 110249 | 3.3 | 46 | 3800123172106 |
| 110250 | 4.0 | 32 | 3800123172113 |
| 110251 | 4.5 | 25 | 3800123172120 |

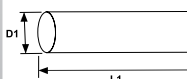

TRIMMER HEAD FOR BRUSH CUTTERS

[BG] Корда с тримерна глава за коса • [RO] Mosor cu fir pentru motocosoitoare • [SR] Najlon za trimer • [MK] Конец за косилка • [RU] Леска для триммера • [SL] Najlonska nitka za obrezovalnik trave • [EL] Κεφαλή μερίνιζας • [HR] Najlonska rezna glava s dvije niti • [FR] Le cordon avec une tête de cheveux en trois dimensions • [IT] La corda con una testa di capelli tridimensionale • [ES] La šnuro kun tridimensia hararo • [PT] O cabo com uma cabeça de cabelo tridimensional

TRIMMER HEAD FOR BRUSH CUTTERS

| art. № | D1 (mm) | L1 (m) | BARCODE |
|--------|---------|--------|---------------|
| 110207 | 2.4 | 3 | 3800123143526 |

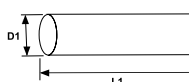

PAPER CARD

TRIMMER HEAD FOR ELECTRIC BRUSH CUTTERS

Art. No. 110273
EAN: 3800972002227



PAPER CARD

UNIVERSAL ALUMINIUM TRIMMER HEAD FOR BRUSH CUTTERS

Art. No. 110262
EAN: 3800123174667



PAPER CARD

UNIVERSAL TRIMMER HEAD FOR BRUSH CUTTERS

| art. № | D1 (mm) | L1 (m) | BARCODE |
|--------|---------|--------|---------------|
| 110228 | 2.4 | 2.5 | 3800123166389 |

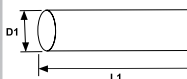

PAPER CARD

EASY LOAD TAP&GO TRIMMER HEAD FOR BRUSH CUTTERS

Art. No. 110234
EAN: 3800123167638



BLISTER

BLADE FOR GASOLINE BRUSH CUTTERS 3 TEETH

[BG] Нож за моторна коса три лъча • [RO] Cutit cu trei lame pentru motocosoitoare • [SR] Sečivo za trimer 3 kraka • [MK] Нож за бензински тример • [RU] Нож для бензиновый тример - газонокосилка • [SL] Nož za travo za motorna kosa • [EL] Ανταλλακτικός δίσκος 3 δοντιών • [HR] Oštrica • [FR] Lame pour débroussaillieuses à essence 3 dents • [IT] Lama per decespugliatori a benzina 3 denti • [ES] Blade por Gasoline Brush Cutters 3 Dentoj • [PT] Lámina para cortadores de escova de gasolina 3 dentes

Art. No. 142101
EAN: 3800123158629

D1
255mm

D2
25.4mm

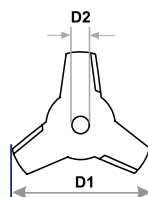

BLISTER

BLADE FOR GASOLINE BRUSH CUTTERS 4 TEETH

[BG] Нож за моторна коса четири лъча • [RO] Cutit cu trei lame pentru motocosoitoare • [SR] Sečivo za trimer 4 kraka • [MK] Нож за бензински тример • [RU] Нож для бензиновый тример - газонокосилка • [SL] Nož za travo za motorna kosa • [EL] Ανταλλακτικός δίσκος 4 δοντιών • [HR] Oštrica 4 zuba • [FR] Couteau de moto à quatre rayons • [IT] Coltello da moto a quattro raggi • [ES] Tranchilo de kvar-raketaj motorbikloj • [PT] Faca de moto de quatro feixes

Art. No. 110229
EAN: 3800123166396

D1
255mm

D2
25.4mm

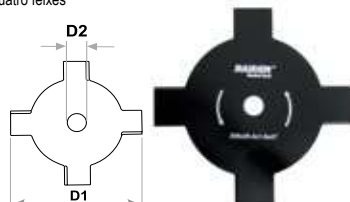

BLISTER

BLADE FOR GASOLINE BRUSH CUTTERS 40 TEETH

[BG] Диск за моторна коса ТСТ • [RO] Disc pentru motocosoitoare • [SR] List testere za trimer • [MK] Кружна пила за бензински тример • [RU] Циркулярный диск для бензиновый триммер - газонокосилка • [SL] Nož za motorna kosa • [EL] Δίσκος πύλα • [HR] Listova pila • [FR] Lame pour débroussaillieuses à essence 40 dents • [IT] Lama per decespugliatori a benzina 40 denti • [ES] Klingo por Gasoline Brush Cutters • [PT] Lâmina para cortadores de escova a gasolina

Art. No. 110230
EAN:3800123166402

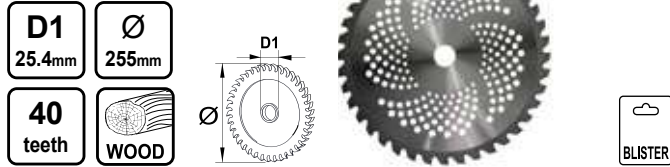

HARNESS FOR BRUSH CUTTERS

• [BG] Самар за моторна коса универсален • [RO] Ham reglabil ptr moto-coasa • [SR] Remen za nošenje • [MK] Ранац за бензински тример • [RU] Ременная оснастка • [SL] Standarden oprtnik • [EL] Εξάρτησι • [HR] Univerzalne naramenice • [FR] Harnais pour débroussaillieuses • [IT] Imbracatura per decespugliatori • [ES] Samar por motoro haro universal • [PT] Chicote de fios para cortadores de escova

Art. No. 110231
EAN:3800123166419



HARNESS WITH SHOULDER STRAPS

[BG] Самар за моторна коса с широки и меки колани универсален червен • [RO] Harnați cu curelele de umăr padding moale pentru tăietoare perie roșu • [SR] Žarenje sa ramenim kaiševima mekano podlogu za sečenje četkica crveno • [MK] Потпирач со ремени со рамно лежиште за црвени четкички • [RU] Жгут с погонами мягкой подкладки для кусторезов красный • [SL] Zadržalo z ramenskimi pasovi mehka obloga za rezila za krtače rdeča • [EL] Απολαύστε με ιμάντες ώμου μαλακή επένδυση για κόπτες βούρτσας κόκκινο • [HR] Kabel s trakama za ramena meki padding za crvene četkice • [FR] Samar pour les cheveux moteur avec ceintures larges et douces universels rouge • [IT] Samar per capelli motore con cinghie larghe e morbide universali rosse • [ES] Samar por motoro haroj kun laržaj kaj molaj zonoj universalaj ružaj • [PT] Samar para cabelos com cintos largos e macios vermelho universal



Art. No. 110284
EAN:3800972003927



HARNESS WITH SHOULDER STRAPS & SOFT PADDING FOR BRUSH CUTTERS

[BG] Самар за моторна коса с широки и меки колани универсален • [RO] Ham reglabil ptr motocoasa • [SR] Remen za nošenje • [MK] Ранац за бензински тример • [RU] Ременная оснастка • [SL] Standarden oprtnik • [EL] Εξάρτησι • [HR] Univerzalne naramenice • [FR] Samar pour les cheveux moteur avec ceintures larges et douces universels • [IT] Samar per capelli motore con cinghie larghe e morbide universali • [ES] Samar por motoro haroj kun laržaj kaj molaj zonoj universalaj • [PT] Samar para cabelos com cintos largos e macios universal



Art. No. 110263
EAN:3800123174674



TRIMMER LINE ON SPOOL FOR GRASS TRIMMER

[BG] Корда с макара за косачка-тример • [RO] Fir rezerva trimmer • [SR] Najlon za trimer • [MK] Конец за косилка • [RU] Леска для триммера • [SL] Najlonska nitka za obrezovalnik trave • [EL] Κεφαλή μεσινέζας • [HR] Najlonska rezna glava s dvije niti • [FR] Trimmer Line sur bobine pour tondeuse à gazon • [IT] Il cavo con un mulinello tagliaerba • [ES] La šnuro kun veturilo-trimmerilo • [PT] O cabo com um carreto aparador

| art. № | D1 (mm) | L1 (m) | BARCODE |
|--------------------------|---------|--------|---------------|
| 110222 for RD-GT11,20 | 1.4 | 3 | 3800123163975 |
| 110223 for RD-GT11,20,26 | 1.2 | 3 | 3800123163982 |
| 110260 for RD-GT21 | | | 3800123174452 |



TRIMMER LINE ON SPOOL WITH CAP FOR GRASS TRIMMER

[BG] Корда с макара и шайба за косачка-тример • [RO] Fir rezerva trimmer cu disc • [SR] Najlon za trimer • [MK] Конец за косилка • [RU] Леска для триммера • [SL] Najlonska nitka za obrezovalnik trave • [EL] Κεφαλή μεσινέζας • [HR] Najlonska rezna glava s dvije niti • [FR] Trimmer Line sur bobine pour tondeuse à gazon • [IT] Il cavo con un mulinello tagliaerba • [ES] La šnuro kun veturilo-trimmerilo • [PT] O cabo com um carreto aparador

Art. No. 110261
EAN:3800123174469

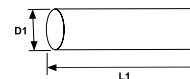

REFILL PACK WITH 10 SAFETY PLASTIC BLADES FOR CORDLESS GRASS TRIMMER

[BG] Ножчета 10 бр. за акум. тример • [RO] Set 10 lame • [SR] Lezvia 10 komada komplet • [MK] Ножеви 10 парчиња комплет • [RU] Клинки 10 штук комплект • [SL] Rezila 10 kos • [EL] Λεπίδες 10 κομ • [HR] Oštrice 10 komada set • [FR] Recharge de 10 lames en plastique de sécurité pour taille-bordure sans fil • [IT] Confezione di ricarica con 10 lame in plastica di sicurezza per tagliaerba a batteria • [ES] Refill Pack Kun 10 sekurecaj plastaj Klingoj por cordless herba trimmer • [PT] Recarga com 10 lâminas de plástico de segurança para aparador de grama sem fio

Art. No. 110252
EAN:3800123174353



10 pcs
↑ ↑ ↑

FOR RD-GTL22



Art. No. 110253
EAN:3800123174360



10 pcs
↑ ↑ ↑

FOR RD-GTL22



BLADE FOR LAWN MOWER

• [BG] Нож за косачка • [RO] Cutit pentru masina de tuns iaba • [SR] Sečivo za kosачica • [MK] Нож за косилка за trava • [RU] Нож для газонокосилка • [SL] Nož za travo za kosilnica • [EL] Ανταλλακτικό Μαχαίρι για Χλοοκοπτικό • [HR] Oštrica • [FR] Couteau de tonte • [IT] Coltello falciante • [ES] Tranchilo trançante • [PT] Faca de corte

| art. № | L1 (m) | BARCODE |
|------------------------|----------------|---------------|
| 110255 for RD-LM17 | 320mm (13") | 3800123174407 |
| 110256 for RD-LM18 | 350mm (14") | 3800123174414 |
| 110257 for RD-LM19 | 420mm (17") | 3800123174421 |
| 110203 for RD-GLM01 | 400mm (16") | 3800123141584 |
| 110264 for RD-GLM04 | 410mm (17") | 3800123174698 |
| 110266 for RD-GLM05 | 460mm (18") | 3800123174797 |
| 110271 for RD-GLM06 | 530mm (20") | 3800972000346 |
| 110278 for RD-LM23 | 400mm (16") | 3800972003637 |

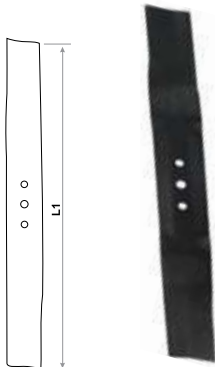

GRASS BAG FOR LAWN

• [BG] Кош за косачка • [RO] Pungă de iarbă pentru mașină de tuns iarbă • [SR] Torba za travu • [MK] Торба за trava за косилка за trava • [RU] Сумка для газонокосилки • [SL] Torba za kosilnico • [EL] Μηχανή γκαζόν • [HR] Kosilica kosh • [FR] Tondeuse à gazon • [IT] Tosaerba • [ES] Lignoçambro • [PT] Saco de grama para cortador de grama

| art. № | BARCODE |
|------------------------|---------------|
| 110277 for RD-LM23 | 3800972003644 |
| 110274 for RD-GLM04 | 3800972003590 |
| 110275 for RD-GLM05 | 3800972003606 |
| 110276 for RD-GLM06 | 3800972003613 |



HOSE FOR HIGH PRESSURE CLEANER

• [BG] Маркуч за водоструйка • [RO] Furtun pentru spalator cu presiune • [SR] Crevo visokog pritiska za perač • [MK] Црево за машина за перенье • [RU] Шланг для мойки высокого давления • [SL] Cev za visokotlačni čistilec • [EL] Αποφρακτικός Σωλήνας Υψηλής Πίεσης • [HR] Visokotlačno crijevo za Visokotlačni čistač • [FR] Tuyau 5m pour les travaux d'eau • [IT] Tubo flessibile 5m per acquedotto • [ES] Hose 5m por akvaj verkoj • [PT] Mangueira 5m para sistema hidráulico

| art. № | Bar | Hose length | BARCODE |
|---------------------------|-----|-------------|---------------|
| 138101 for RD-HPC01,04 | 100 | 5m | 3800123158476 |



| art. № | Bar | Hose length | BARCODE |
|---------------------------|-----|-------------|---------------|
| 139962 for RD-HPC02 | 140 | 8m | 3800123115813 |
| 138121 for RD-HPC07,08 | 200 | 8m | 3800972016040 |
| 138113 for RD-HPC05 | 120 | 6m | 3800972009974 |



GUN FOR HIGH PRESSURE CLEANER

• [BG] Пистолет за водоструйка • [RO] Pistol pentru aparat de spalat cu presiune • [SR] Pištol za perač • [MK] Пиштол за машина за перенье • [RU] Пистолет для мойки высокого давления • [SL] Pištola za pranje • [EL] Πιστόλι για πλυτικό υψηλής πίεσης • [HR] Pištolj za Visokotlačni čistač • [FR] Arme à feu • [IT] Pistola • [ES] Pafilo • [PT] Pistola de ar

| art. № | BARCODE |
|---------------------------|---------------|
| 138117 for RD-HPC07,08 | 3800972016002 |
| 138102 for RD-HPC02 | 3800123158483 |
| 138114 for RD-HPC05 | 3800972009981 |



| art. № | BARCODE |
|---------------------------|---------------|
| 139960 for RD-HPC01,04 | 3800123115790 |



LANCE GUN FOR HIGH PRESSURE CLEANER

• [BG] Накрайник за пистолет на водоструйка • [RO] Lance pentru pistol aparat de spalat cu presiune • [SR] Nastavak visokog pritiska za perač • [MK] Спoјкa за машина за перенье • [RU] Струйная насадка • [SL] Razpršilna šoba za visokotlačni čistilec • [EL] Προεκταση κανής • [HR] Rotacijska mlaznica za Visokotlačni čistač • [FR] Pointe de pistolet hydraulique • [IT] Punta della pistola a pistola idraulica • [ES] Hidráulica pafilo • [PT] Ponta da pistola hidráulica

| art. № | BARCODE |
|------------------------------|---------------|
| 138118 for RD-HPC07,08 | 3800972016019 |
| 138103 for RD-HPC01,02,04 | 3800123158490 |



| art. № | BARCODE |
|------------------------------|---------------|
| 139961 for RD-HPC01,02,04 | 3800123115806 |
| 138116 for RD-HPC05 | 3800972010000 |



ROTARY BRUSH KIT FOR HIGH PRESSURE CLEANER

• [BG] Четка ротациона за водоструйка • [RO] Perie pentru aparat de spalat cu presiune • [SR] Četka za perač • [MK] Четка за машина за перенье • [RU] Вращающаяся щетка для мойки высокого давления • [SL] Akumulatorski Vrtalniki Vijasnik • [EL] Βούρτσας περιστροφική πλυσίματος γενικής χρήσης για πλυστικά • [HR] Rotirajuća četka za Visokotlačni čistač • [FR] Brosse rotative pour jet d'eau • [IT] Spazzola rotante per getto d'acqua • [ES] Rotacia broso por akvoplugo • [PT] Escova rotativa para jato de água

| art. № | BARCODE |
|------------------------------|---------------|
| 138119 for RD-HPC07,08 | 3800972016026 |
| 138105 for RD-HPC01,02,04 | 3800123158513 |



DETERGENT TANK FOR HIGH PRESSURE CLEANER

• [BG] Контейнер за препарат за водоструйка • [RO] Cisternă pentru aparat de spalat cu presiune • [SR] Posuda za šampon za perač • [MK] Контејнер за машина за перенье • [RU] Насадка для пенной чистки • [SL] Posodica za detergent • [EL] Απορριπταντικό με δοχείο • [HR] Mlaznica sa spremnikom deterđenta • [FR] Conteneur pour la préparation au jet d'eau • [IT] Contenitore per la preparazione a getto d'acqua • [ES] Enhavanto por akvopara preparado • [PT] Recipiente para preparação de jato de água

| art. № | BARCODE |
|---------------------------|---------------|
| 138120 for RD-HPC07,08 | 3800972016033 |
| 138104 for RD-HPC01,02,04 | 3800123158506 |
| 138115 for RD-HPC05 | 3800972009998 |



BAG FOR BLOWER VACUUM

[BG] Торба за листосъбирач • [RO] Sac colector • [SR] Preklopna torba za skropljenje • [MK] Преклопна вретена за скрепи • [RU] Складной скребок • [SL] Zložljiva torba za strgalo • [EL] Πτυσσόμενη σακούλα απόξεσης • [HR] Sklopiva vrećica za struganje • [FR] Sac à raclette pliable • [IT] Sacca raschietto pieghevole • [ES] Foldanta kraketa sako • [PT] Saco de raspador dobrável

| art. № | L (capacity) | BARCODE |
|------------------------|-----------------|---------------|
| 075523 for RD-EBV03 | 35 | 3800123173509 |
| 075539 for RD-EBV04 | 35 | 3800972002067 |



BAG FOR GASOLINE BLOWER VACUUM

| art. № | L (capacity) | BARCODE |
|------------------------|-----------------|---------------|
| 140401 for RD-GBV05 | 30 | 3800972003729 |



TILE CUTTER BLADE

[BG] Резец за машина за плочки • [RO] Cap taiere placi • [SR] Nož za mašinu zasečenje pločica • [MK] Сечило за машина за сечење на плочки • [RU] Резак машина для резки плитки • [SL] Rezalnik za keramične ploščice • [EL] Κοπή για Κόφτες Πλακιδίων Χειρός • [HR] Nož za ručna pila, precizna za kut • [FR] Lame de coupe de tuile • [IT] Tagliapiastrelle • [ES] Tondilo de Kahelo • [PT] Lâmina de corte de telha

| art. № | Ø (mm) | BARCODE |
|-----------------------------|-----------|---------------|
| 321518 for RD-TC01,02,03 | 15x6x1.5 | 3800123150456 |
| 321521 for RD-TC16 | 16x4x3 | 3800123104749 |



| art. № | Ø (mm) | BARCODE |
|-----------------------------|-----------|---------------|
| 321504 for RD-TC10,12,13 | 15x6x2 | 3800123116353 |
| 321520 for RD-TC11,14,18 | 22x10.5x2 | 3800123153938 |



NOZZLE, NEEDLE & AIR CAP SET

• [BG] Дюза, игла и капачка за бояджийски пистолет • [RO] Set duza pentru pistol de vopsit • [SR] Dizna za pn. Pištolj za farbanje • [MK] Резервни прскалки - дизна, игла и капачка за пиштол за фарбање • [RU] Набор дополнительных сопел (воздушная голова, красочное сопло и игла) для краскопульта • [SL] Šoba za lakirne pištole • [EL] Βελώνια, ακροφύσιο & πώμα αέρος • [HR] Mlaznica za raspršivanje boje set • [FR] Bouchon de buse, aiguille et pistolet à peinture • [IT] Ugello, ago e cappuccio della pistola di vernice • [ES] Nozzle, nadlo kaj pentri pafilon çapo • [PT] Bocal, agulha e tampa de pistola de pintura



| art. № | Ø (mm) | BARCODE |
|--------------------|-----------|---------------|
| 110907 for RD-SG04 | Ø1.5 mm | 3800123165399 |
| 110909 for RD-SG05 | Ø1.2 mm | 3800123173042 |
| 110908 for RD-SG05 | Ø1.4 mm | 3800123165405 |
| 110910 for RD-SG05 | Ø1.8 mm | 3800123173059 |
| 110911 for RD-SG05 | Ø2.0 mm | 3800123173066 |
| 110913 for RD-SG07 | Ø2.0 mm | 3800123173677 |



CUP FOR RD-SG05

• [BG] Казанче за бояджийски пистолет RD-SG05 • [RO] Rezervor pentru pistol de vopsit • [SR] Plastično lonče za pištolj za farbanje • [MK] Пластичен сад за спреј пиштол • [RU] Бак нейлоновый для краскопульта • [SL] Dozirni lonček • [EL] Άνω δοχείο PVC πιστολιών βαφής • [HR] Plastično lonče za pištolj za boju • [FR] Atelier de peinture pour la peinture au pistolet • [IT] Negozio di vernici per verniciatura a pistola • [ES] Paint-vendejo por pafotrapo • [PT] Loja de pintura para pintura de armas

| art. № | ml (capacity) | BARCODE |
|-----------------------|------------------|---------------|
| 110912 for RD-SG05 | 600 | 3800123173073 |



SILICONE CARBIDE SAND FOR SANDBLASTING

• [BG] Пясък абразивен за пясъкоструен пистолет • [RO] Nisip carbură de siliciu • [SR] Abrazivni pesok • [MK] Песок абразивен • [RU] Порошок абразивный • [SL] Vakrova žindra • [EL] Λειαντικός άμμος • [HR] Brusni pijesak • [FR] Sable abrasif pour un pistolet de sablage • [IT] Sabbia abrasiva per una pistola di sabbatura • [ES] Abrasiva sablo por sandblast pafilo • [PT] Areia abrasiva para uma pistola de jato de areia

| art. № | kg | BARCODE |
|--------|----|---------------|
| 160151 | 1 | 3800123166655 |



HEPA FILTER

• [BG] HEPA филтър • [RO] Filtru HEPA • [SR] HEPA filter • [MK] HEPA филтер • [RU] HEPA фильтр • [SL] HEPA filter • [EL] Φίλτρο HEPA • [HR] HEPA filter • [FR] Filtre HEPA • [IT] Filtro HEPA • [ES] HEPA-filtrilo • [PT] Filtro HEPA

HEPA FILTER FOR METAL ASH CLEANER

| art. № | L (capacity) | BARCODE |
|-------------------------------|-----------------|---------------|
| 090307 for metal container | 18 | 3800972003316 |



HEPA FILTER FOR VACUUM CLEANER

| art. № | L (mm) | Ø (mm) | BARCODE |
|-----------------------|-----------|-----------|---------------|
| 090302 for RD-WC01 | 116 | 122 | 3800123167843 |
| 090305 for RD-WC02 | 108 | 123 | 3800123173684 |
| 090309 for RD-WC03 | 120 | 100 | 3800972008830 |
| 090311 for RD-WC04 | 107 | 137 | 3800972012639 |



ENGINE OIL SAE30 1L

• [BG] Масло SAE30 1L • [RO] Ulei de motor SAE 30 1L • [SR] Motorno ulje SAE 30 1L
 • [MK] Моторно масло SAE 30 1L • [RU] Моторное масло SAE 30 1л • [SL] Motorno olje SAE 30 1L
 • [EL] Λάδι κινητήρα SAE 30 1L • [HR] Motorno ulje SAE 30 1L • [FR] Huile moteur SAE 30 1L
 • [IT] Olio motore SAE 30 1L • [ES] Engine Oil SAE 30 1L • [PT] Óleo de Motor SAE 30 1L

Art. No. 075906
 EAN: 3800972005105

Art. No. 075903
 EAN: 3800123172076



Two Stroke Oil 2T MIX
Масло за двутактови
двигатели 2T MIX
1000 ml

GEAR OIL EP90 1L

• [BG] Масло трансмисионно EP90 1L • [RO] Ulei de transmisie EP 90 1L • [SR] Prenosno ulje EP 90 1L
 • [MK] Преносно масло EP 90 1L • [RU] Трансмисионное масло EP 90 1L • [SL] Prenosno olje EP 90 1L
 • [EL] Λάδι κιβωτίου ταχυτήτων EP 90 1L • [HR] Ulje mjenjača EP 90 1L • [FR] Huile de transmission EP 90 1L
 • [IT] Olio cambio EP 90 1L • [ES] Transdono petrolo EP 90 1L • [PT] Óleo de Transmissão EP 90 1L

Art. No. 075902
 EAN: 3800123172069



TWO STROKE SEMI SYNTHETIC LOW STROKE OIL 1L

• [BG] Масло за двутактови двигатели полусинтетично бездимно
 • [RO] Ulei de transmisie • [SR] Prenosno ulje • [MK] Преносно
 масло • [RU] Трансмисионное масло • [SL] Prenosno olje
 • [EL] Λάδι κιβωτίου ταχυτήτων • [HR] Ulje mjenjača • [FR] Huile de
 transmission • [IT] Olio cambio • [ES] Transdono petrolo • [PT] Óleo
 de Transmissão



Art. No. 075905
 EAN: 3800972002487

BLOW TORCH FOR CARTRIDGE PIEZO

• [BG] Горелка за патрон с пиезо • [RO] Lampă de gaz cu arzător • [SR] Gasni brener • [MK] Горилник
 со тенк • [RU] Газовая горелка • [SL] Plinski gorilnik • [EL] Καμινέτο υγραερίου • [HR] Plamenik Plinski
 • [FR] Brûleur à gaz • [IT] Bruciatore a gas • [ES] Gasfumilo • [PT] Queimador a gás

Art. No. 450101
 EAN: 3800123164606



BLOW TORCH

[BG] Горелка със спусък • [RO] Arzator • [SR] Gasni brener • [MK] Горилник со активирање
 • [RU] Газовая горелка • [SL] Plinski gorilnik • [EL] Καμινέτο υγραερίου • [HR] Plamenik Sa
 Ručkom • [FR] Brûleur • [IT] Bruciatore • [ES] Burner • [PT] Queimadoro

| art. № | Ø (mm) | L1 (mm) | BARCODE |
|---------------------|--------|---------|---------------|
| 491512 for RD-GHT01 | 40 | 30 | 3800123118722 |
| 491513 for RD-GHT02 | 50 | 40 | 3800123118739 |
| 491514 for RD-GHT03 | 60 | 40 | 3800123118746 |

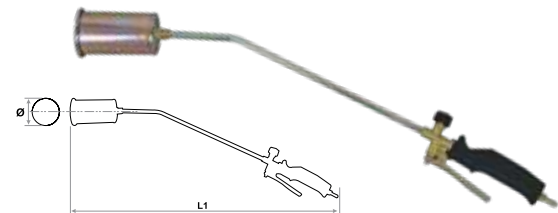

MOBILE SYSTEM WHEEL BASE

• [BG] Основа на колела за мобилна система • [RO] Baza roti sistem mobil • [SR] Kolica za ladice [MK]
 Носач на мобилен систем • [RU] Тележка для пластмассового ящика • [SL] Kовček za orodje plastični
 • [EL] Πλατφόρμα εμπορευμάτων τροχήλατη • [HR] Kolica za ladice • [FR] Chariot pour boîte en plastique
 • [IT] Carrello per scatola di plastica • [ES] Carro para caja de plástico • [PT] Carrinho para caixa de plástico

| art. № | Sze cm | BARCODE |
|--------|------------|---------------|
| 139612 | 46.5x33x11 | 3800972012370 |



SAFETY GLASSES WITH UVA400 AND ANTI SCRATCH PROTECTION

• [BG] Очила предпазни с UVA400 и защита против надраскване • [RO] ochelari de
 protecție • [SR] заштитне наочаре • [MK] заштитни очила • [RU] защитные очки
 • [SL] zaščitna očala • [EL] προστατευτικά γυαλιά • [HR] zaštitne naočale • [FR] lunettes de
 sécurité • [IT] occhiali di sicurezza • [ES] gafas protectoras • [PT] óculos de segurança



Art. No. 561401
 EAN: 3800972016170

SAFETY HELMET, STEEL MESH AND EARMUFF

• [BG] Каска, мрежа и антифони предпазни • [RO] Cască de
 protecție • [SR] Заштитни шлем • [MK] Безбедносен шлем
 • [RU] Шлем безопасности • [SL] Varnostna čelada • [EL] Κράνος
 ασφαλείας • [HR] Cascu di securità • [FR] Casque de sécurité
 • [IT] Casco di sicurezza • [ES] Casco de seguridad
 • [PT] Capacete de segurança



Art. No. 561301
 EAN: 3800972016163

MAGNET TORPEDO LEVEL

• [BG] Нивелир с магнит • [RO] Nivelă • [SR] Ниво магнетног торпеда
 • [MK] Магнетно ниво на Торпедо • [RU] Магнитный торпедный
 уровень • [SL] Magnetna raven torpeda • [EL] Επίπεδο μαγνητικής
 торπίλης • [HR] Razina magnetskog torpeda • [FR] Niveau de
 torpille magnétique • [IT] Torpedo magnetico • [ES] Nivel de
 torpedo magnético • [PT] Nivel de torpedo magnético



Art. No. 549789
 EAN: 3800972002210

DUST COLLECTOR FOR IMPACT DRILL Ø10

• [BG] Прахоуловител за бормашина за свредла до Ø10mm • [RO] Colector de praf
 pentru găurit • [SR] Сакупљач праšине за бушилицу • [MK] Колектор за прашина за
 вежба • [RU] Пылеуловитель для дрели • [SL] • [EL] Συλλέκτης σκόνης για τρυπάνι
 • [HR] Sakupljač prašine za bušilicu • [FR] Collecteur de poussière pour perceuse
 • [IT] Depolverizzatore per trapano • [ES] Colector de polvo para taladro
 • [PT] Coletor de pó para broca



Art. No. 499801
 EAN: 3800972001497

TOOL BAG 18"

• [BG] Чанта за инструменти 18" • [RO] Geanta scule • [SR] Torba za alat • [MK] Торба за алатки
• [RU] Мешка для инструмента • [SL] Vreča za orodja • [EL] Τσάντα μαστόρων • [HR] Torba s alatom • [FR] Caisse à outils
• [IT] Borsa degli attrezzi • [ES] Saco de herramientas • [PT] Bolsa de ferramentas



Art. No. 499941

EAN: 3800972012479

PLASTIC CASE FOR MOBILE SYSTEM WITH ORGANISER

[BG] Пластмасов куфар за инструменти с организер • [RO] Cutie pentru scule
• [SR] Kutija za alat plasticna • [MK] Кутија за алат од пластика • [RU] Ящик для инструментов • [SL] Kovček za orodje plastični • [EL] Εργαλειοθήκη κουτία πλαστική
• [HR] Kutija za alat plasticna • [FR] Servante mobile en plastique • [IT] Scatola degli attrezzi di plastica • [ES] Caja de herramientas modular plastica
• [PT] Caixa de ferramentas plastica



| art. № | Size cm | capacity kg | BARCODE |
|--------|------------|----------------|---------------|
| 139610 | 44x32x15 | 15 | 3800972012356 |

PLASTIC CASE FOR MOBILE SYSTEM

























[BG] Пластмасов куфар за инструменти • [RO] Cutie pentru scule • [SR] Kutija za alat plasticna
• [MK] Кутија за алат од пластика • [RU] Ящик для инструментов • [SL] Kovček za orodje plastični
• [EL] Εργαλειοθήκη κουτία πλαστική • [HR] Kutija za alat plasticna • [FR] Servante mobile en plastique
• [IT] Scatola degli attrezzi di plastica • [ES] Caja de herramientas modular plastica • [PT] Caixa de ferramentas plastica























| art. № | Size cm | capacity kg | BARCODE |
|--------|------------|----------------|---------------|
| 139611 | 44x32x25.5 | 18 | 3800972012363 |



Meaning of Pictograms / Описание на Пиктограмите

| | | | |
|--|---|---|--|
|  <p>230V~50Hz</p> | <p>Power supply • Захранване • Tensione in trare • Napajanje • Напон • Источник питания • Napetost • Τροφοδοσία • Napajanje • Source de courant • Alimentazione elettrica • Fonte de nutrado • Fonte de energia</p> |  <p>LASER</p> | <p>Device is equipped with laser indicator • Машината е снабдена с лазерен индикатор • Echipat cu indicator laser • Машина poseduje laserski indikator • Уредот е опремен со ласерски индикатор • Устройството осначено индикатором лазерный • Vsebuje laser • Η συσκευή είναι εξοπλισμένη με δείκτη λέιζερ • Laser • L'appareil est équipé d'un indicateur laser • Il dispositivo è dotato di indicatore laser • Aparato estas ekipita per lasera indikilo • O dispositivo está equipado com indicador de laser</p> |
|  <p>950W</p> | <p>Power • Мощност • Putere • Snaga • Моќност • Питание • Моќ • Εξουσία • Snaga • Puissance • Energia • Potenco • Poder</p> |  <p>LCD DISPLAY</p> | <p>Dust Capture • Прахоулавње • Praf de extracție • Усисавање • Прав факње • Очистка воздуха от пыли • Odsesavanje • Ανορθόφηση σκόνης • За праšinu • Capture de poussière • Cattura della polvere • Kovnilo de Polvo • Captura de poeira</p> |
|  <p>0-1000 min⁻¹</p> | <p>Maximum rotations • Обороты • Nr. maxim rotatii • Максimalni broj obrtaja • Максимални вртежи • Максималният вращения • Število vrteljev • Μέγιστος τριπλιτος • Revolucje • Rotations maximales • Rotazioni massime • Maksimumaj rotacioj • Rotações máximas</p> |  <p>45°</p> | <p>Cutting angle adjustment • Рязане под ъгъл • Ajustare unghi taiera • Sebeñanje pod ugolom • Сеченье под агол • Регулировка угла резания • Nastavljivj kot rezanja • Κοπή ρυθμιζόμενη γωνίας • Kut rezanja • Réglage de l'angle de coupe • Regolazione dell'angolo di taglio • Angleustiga angulo • Ajuste do ângulo de corte</p> |
|  <p>3.5 kg</p> | <p>Max. drilling diameter in metal • Макс. диаметър на пробиване в метал • Diametru maxim gaurire metal • Maks. prečnik probijanja kroz metal • Макс. диаметар на дупчење во метал • Макс. диаметр сверления в металле • Maks. premer vrtanja v kovino • Μέγιστη διάμετρος τριπλιτος σε μέταλλο • Maks. promjer bušenja u metalu • Max. diamètre de perçage en métal • Max. diametro di foratura in metallo • Maks. boranta diametro en metalo • Max. diâmetro de perfuração em metal</p> |  <p>Ø [mm] 185x20x18T</p> | <p>Circular disc dimensions • Размери на диска за циркуляр • Dimensiuni disc • Dimenzije diska • Размер на дискот • Диск размери • Velikosti diska • Διαστάσεις δίσκου • Velicina kružnog diska • Dimensions du disque circulaire • Dimensiões del disco circolare • Cirkulaj diskodimensioj • Dimensões do disco circular</p> |
|  <p>VARIABLE SPEED</p> | <p>Max. drilling diameter in concrete • Макс диаметър на пробиване в бетон • Diametru maxim gaurire in beton • Maks. prečnik probijanja kroz beton • Макс. диаметар на дупчење во бетон • Макс. диаметр сверления в бетоне • Maks. premer vrtanja v betonu • Μέγιστη διάμετρος τριπλιτος σε μπετόν • Maks. promjer bušenja u beton • Max. diamètre de perçage dans le béton • Max. boranta diametro en betono • Max. diâmetro de perfuração concreto</p> |  <p>63 mm (max)</p> | <p>Cutting depth in wood • Дълбочина на рязане в дрво • Adancime taiera in lemn • Dubina sečenja kroz drvo • Длабочина на сеченье во дрво • Глубина пропила в дрвесине • Globina reza • Βόθος κοπής σε ξύλο • Dubina rezanja u drvu • Profondeur de coupe dans le bois • Profondità di taglio in legno • Trança profundo en ligno • Profundidade de corte em madeira</p> |
|  <p>L R</p> | <p>Max. drilling diameter in wood • Макс. диаметър на пробиване в дрво • Diametru maxim gaurire in lemn • Maks. prečnik probijanja kroz drvo • Макс. диаметар на дупчење во дрво • Макс. диаметр сверления в дрвесе • Maks. premer vrtanja v les • Μέγιστη διάμετρος τριπλιτος σε ξύλο • Maksimalni promjer bušenja u drvu • Max. diamètre de perçage dans le bois • Max. diametro di foratura in legno • Maks. boranta diametro en madeira • Energia do martelo por curso</p> |  <p>0-3 mm</p> | <p>Planning depth • Дълбочина на рендосване • Adancime maxima prelucrare • Dubina renđanja • Длабочина на стругање • Глубина строгания • Nastavljivj globina utora • Βόθος πλάνοιζατος • Dubina planiranja • Profondeur de planification • Profondità di pianificazione • Planado de profundo • Profundidade de planejamento</p> |
|  <p>1-16mm</p> | <p>Hammer energy per stroke • Макс. енергија на единичен удар • Max. energie provenind un pumn singur • Макс. енергија једног удара • Макс. енергија на еден удар • Макс. Енергија, получаемом одним ударом • Max. energia, pridobljena en udarcu • Max. Ενέργεια του προυχρητα για ενιαία χροιά • Max. енергија једном potezu • Marteau energie par coup • Energia del martello per colpo • Martela energia per streko</p> |  <p>82 mm</p> | <p>Planning maximum width • Макс. ширина на рендосване • Latime maxima prelucrare • Maksimalna širina renđanja • Макс. ширина на стругање • Ширина строгания • Nastavljiva širina • Πλάτος πλάνοιζατος • Širina blanjanja • Planifier la largeur maximale • Pianificazione della larghezza massima • Planante maksimumum larğon • Largura maxima de planejamento</p> |
|  <p>Impact function</p> | <p>Impact function • Ударна функција • Functie impact • Udarana funkcija • Ударна функција • Импакт функција • Udarana funkcija • Λειτουργία των επιπτώσεων • Udarce funkcija • Fonction d'impact • Funzione d'impatto • Trafo funkcio • Função de impacto</p> |  <p>8 mm</p> | <p>Collet sleeves diameter • Диаметър на цангата • Diametru mandrina freza electrica • Prečnik stezne čaure • Диаметар на футер • Цановый диаметр • Premier stroicnik • Διάμετρος τοку • Promjer stezne čahure • Diamètre des manchons • Diametro delle maniche delle pizze • Pinça maniko diametro • Diâmetro de mangas</p> |
|  <p>Keyless chuck</p> | <p>Impact rate at no-load speed • Честота на ударите • Rata de impact si viteza in afara sarcinii • Уčestalost udaraca Брзина на ударот во празен од • Частота ударов на холостом ходу • скорост • Število udarcev • Αριθμός κρούσεων στο ρελαντί • Učestalost moždanog udara • Таux д'impact à la vitesse à vide • Velocità d'impatto a velocità a vuoto • Trafo-rapidece senčese • Taxa de impacto na velocidade sem carga</p> |  <p>0-40 mm</p> | <p>Plunge depth • Ход на фрезовацката глава • Afundare maxima • Ulaz za glavu frezera • Од на главата на фрезата • Окуничать глубины • Stroke rezkalna glava • Βόθος βουτιά • Potezom mljevenja glave • Profondeur de plongée • Profondità di immersione • Profundidgu • Profundidade de mergulho</p> |
|  <p>COLOR BOX</p> | <p>Wrap in color box • Опаковано в цветна кутија • Ambalaj colorat • Uprakovano u kutiji u boji • Спакувано во кутија • Обверните в коробке цвета • Zavijte ga v polju barva • Туλιците се култи хуријатос • Pakiranje u kutiji u boji • Envelopper dans la boîte de couleur • Avvolgi nella scatola dei colori • Envolvijo en kolora skatolo • Embrulhar em caixa de cor</p> |  <p>120-380 m/min</p> | <p>Belt transport speed • Скорост на лентата • Viteza curea transmisie • Brzina trake • Издржливост на ременот • Скорост протегивањето ленти • Hitrost krožnega brusilca • Ταχύτητα ταινίας • Brzina trake • Courroie de transport • Velocità di trasporto della cinghia • Rapido de transporte de zono • Velocidade de transporte da correia</p> |
|  <p>Case packing</p> | <p>Spindle lock • Блокровка на вала • Buton blocare ax • Blokator talasa • Блокада на вратило • Блокровка шинделња • Snemalni gumb • То клејдишо то дрво • Zaključavanje osovine • Blocage de la broche • Blocco del mandrino • Spinita seruo • Bloqueio do eixo</p> |  <p>76x533 mm</p> | <p>Belt dimensions • Размери на шкурката за лентос • Dimensiuni curea transmisie • Dimenzija šmirgle za trakasto šlafovanje • Големина на шмирглата • Размери ленти • Dimenzija brusnega traku • Ζώνη διαστάσεις • Velicina papirni za Tračna brusilica • Dimensions de la ceinture • Dimensioni della cinghia • Zonoj • Dimensões da correia</p> |
|  <p>2x GEARS</p> | <p>Inner diameter of the disc • Втрешен диаметър на диска • Diametru interior disc • Unutrašnji prečnik diska • Напон • Внутренний диаметр дисков • Внатрешен диаметар на дискот • Εσωτερική διάμετρος του δίσκου • Unutarnji promjer diska • Diamètre intérieur du disque • Diametro interno del disco • Interna diametro de la disko • Diâmetro interno do disco</p> |  <p>22.2 mm</p> | <p>Mixing paddle length • Дължина на бъркалката • Lungime paleta mixare • Dužina mešalice • Должина на мешалката • Длина смешивания веспом • Dolžina mešanje veslo • Αύχμητή μίχκος κοπτή • Dulžina miješalicom • Longueur de la palette de mélange • Lunghezza della palette di miscelazione • Miksado de padeloko • Comprimento da pá de mistura</p> |











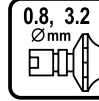

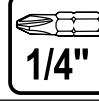







Meaning of Pictograms / Описание на Пиктограмите

| | | | | | |
|---|---|--|--|---|---|
|  <p>CHARGING TIME 1h</p> | <p>Charging time • Време за зареждане на батерията • Timp de încărcare a bateriei • Vreme punjenja baterije • Време на пълнене на батерията • Време заряди акумулатора • Čas polnjenja baterije • Ο χρόνος φόρτισης της μπαταρίας • Vrijeme punjenja baterija • Temps de charge • Tempo di carica • Tempo de sarço • O tempo de carga</p> |  <p>115 mm</p> | <p>Cutting depth in wood • Дълбочина на рязане в дърво • Adancime taiere in lemn • Dubina sečenja kroz drvo • Длабочина на сечене во дрво • Глубина пропила в дресевине • Globina reza • Βάθος κοπής σε ξύλο • Dubina rezanja u drvu • Profondeur de coupe dans le bois • Profondità di taglio in legno • Trança profundo em ligno • Profundidade de corte em madeira</p> |  <p>Ø120/140 mm</p> | <p>Mixing paddle diameter • Диаметър на бъркалката • Diametru paleta mixare • Prečnik mešalice • Диаметар на мешаклата • Диаметр смешивание веспом • Mešanje veslo premera • Αντίστοιχο διάμετρο κοπτή • Promjer miješalcom • Diamètre de la palette de mélange • Diametro della palette di miscelazione • Miksante diametron • Diâmetro da pá de mistura</p> |
|  <p>18 V</p> | <p>Voltage • Волтаж • Voltaj • Voltaža • Напон • Напряжение • Napetost • Δυναμικό • Napon • L'voltage • Voltaggio • Tensio • Voltagem</p> |  <p>90 mm</p> | <p>Max cutting depth in metal • Макс. дълбочина на рязане в метал • Adancime maxima de taiere in metal • Maksimalna dubina sečenja kroz metal • Максимальна длабочина на сечене во метал • Максимальная глубина резания металлов • Največja globina reza v kovino • Μέγιστο βάθος κοπής μετάλλων • Maks. dubina rezanja u metalu • Profondeur de coupe max en métal • Massima profondità di taglio in metallo • Maksimuma trança profundo em metalo • Profundidade máxima de corte em metal</p> |  <p>0.30 L/min</p> | <p>Maximum capacity • Максимален капацитет • Capacitate maxima • Maksimalni kapacitet • Максимальная емкость • Največji pretok • Η μέγιστη χωρητικότητα • Maksimalni kapacitet • Capacité maximale • Capacità massima • Maksimuma kapacito • Capacidade máxima</p> |
|  <p>42 Nm</p> | <p>Torque • Въртящ момент • Cuplu maxim • Obrtni momenat • Вртежен момент • Крутящий момент • Моџ в Nm • Potņi • Zakretnog momenta • Couple • Momento torcente • Paro • Esforço de torção</p> |  <p>90 mm</p> | <p>Max cutting depth in PE / PP • Макс дълбочина на рязане в PE / PP • Adancime maxima de taiere in PE / PP • Maks. dubina sečenja kroz PE / PP • Максимальна длабочина на сечене во PE / PP • Максимальная глубина резания PE / PP • Največja globina reza v PE / PP • Μέγιστο βάθος κοπής PE / PP • Maks. dubina rezanja u PE / PP • Profondeur de coupe max en PE / PP • Profondità di taglio massima in PE / PP • Maksimuma trança profundo em PE / PP • Profundidade máxima de corte em PE / PP</p> |  <p>Ø0.8mm</p> | <p>Container capacity • Объем на контейнера • Capacitate recipient • Kapacitet kontejnera • Капацитет на контейнерот • Объем контейнера • Frostomina posode • Όγκος δοχείου • Volumen spremnika • Capacité du conteneur • Capacità del contenitore • Kapabilo • Capacidade do recipiente</p> |
|  <p>16 + 1</p> | <p>Torque control range • Степени на регулиране на въртящия момент • Control putere-cuplu • Stepan regulacije unutrašnjeg momenta • Степен на регулация на вртежниот момент • Диапазон управления моментом • Navoga območje • Potņi ējros ēlēģuma • Stupanj kontrole momenta • Plage de contrôle de couple • Campo di controllo della coppia • Paro kontrolo gamo • Faixa de controle de torque</p> |  <p>24 mm</p> | <p>Move of the knife • Ход на ножа • Accident vascular cerebral lama • Нод ножа • Потег на мечот • Ход лезвия • Нод rezila • Ευκερφακό η λαιβό • Pomiscanje noz • Mouvement du couteau • Spostamento del coltello • Movó de la trançilo • Mover da faca</p> |  <p>115 mm</p> | <p>Paint nozzle diameter • Диаметър на дюзата за боя • Diametru duza • Prečnik mlaznice za boju • Диаметар на дюзната • Диаметер сопла для краски • Premer šobe za barve • Διάμετρος πύκτου υλικού βαφής • Promjer mlaznice boja • Diamètre de la buse de peinture • Dipingi il diametro dell'ugello • Pentras cigaredon diametron • Diâmetro do bico de pintura</p> |
|  <p>Ø125mm</p> | <p>Diameter of abrasive disc • Диаметър на шлифовъчния диск • Diametru disc abraziv • Prečnik diska za šljafovanje • Диаметар на абразивниот диск • Диаметер шлифовального диска • Premer brusilnega diska • Διάμετρος δίσκου τυπ λειαντικού • Promjer brusa • Diamètre du disque abrasif • Diametro del disco abrasivo • Diametro de abrasia disko • Diâmetro do disco abrasivo</p> |  <p>12.7 mm</p> | <p>Disc dimensions • Размери на диска • Dimensiuni disc • Dimenzije diska • Размер на диск • Диск размери • Velikosti diska • Διαστάσεις δίσκου • Veličina diska • Dimensions du disque • Dimensioni del disco • Dimensiaj diskov • Dimensões do disco</p> |  <p>Ø [mm] 210x30mm</p> | <p>Base dimensions of finishing sander • Размери на шурката • Dimensiunile bazei de slefuire • Dimenzije šmirgle • Диаметар на базата на шнајферката • Базовые размеры отделочных шлифовальный • Osuvnina dimenzija brusnega papirja • Διαστάσεις βάσης της τριβείας πινελιού • Veličina brusnih papirnov • Dimensions de base de la ponceuse de finition • Dimensioni di base della levigatrice di finitura • Bazo-dimensioj de finado de polvo • Dimensões da base da lixadeira de acabamento</p> |
|  <p>230V~ 50Hz</p> | <p>Power supply • Захранване • Tensiune intrare • Napajanje • Напон • Источник питания • Napetost • Трофопоδот • Napajanje • Source de courant • Alimentazione elettrica • Fonte de nutrado • Fonte de energia</p> |  <p>10 MPa</p> | <p>Maximum pressure • Максимално налягане • Presiune maxima • Maksimalni pritisk • Максимален притисок • Максимальное давление • Maksimalni pritisk • Μέγιστη πίεση • Maksimalni pritisk • Pression maximale • Pressione massima • Maksimuma premo • Pressão máxima</p> |  <p>0-45°</p> | <p>Cutting angle adjustment • Рязане под ъгъл • Ajustare unghi taiere • Sečenjenje pod uglom • Сечене под агол • Регулировка угла резания • Nastavljiv kot rezanja • Κοπή πύθιση γωνίας • Kut rezanja • Réglage de l'angle de coupe • Regolazione dell'angolo di taglio • Angleustiga angulo • Ajuste do ângulo de corte</p> |
|  <p>760 W</p> | <p>Power • Мощност • Putere • Snaga • Мојност • Питание • Моџ • Εξουσία • Snaga • Puissance • Energia • Potenco • Poder</p> |  <p>M12-M24</p> | <p>Bolt thread dimensions • Размер на резбата на болта • Dimensiunea de fire suruburi • Veličina šrafovske niti • Големина на заврската • Velikost rezbane niti • Μέγεθος σπειρώματις βιδών • Iznos vijak niti • Dimensions du filetage du boulon • Dimensioni della filettatura del bullone • Dimensio de riglio • Dimensões da rosca</p> |  <p>24T</p> | <p>Circular disc dimensions • Размери на диска за циркулар • Dimensiuni disc • Dimenzije diska • Размер на дискот • Диск размери • Velikosti diska • Διαστάσεις δίσκου • Veličina kružnom disku • Dimensions du disque circulaire • Planifier la largeur maximale • Pianificazione della larghezza massima • Planante maksimumam larjon • Largura máxima de planeamento</p> |
| <p>0-2600 min⁻¹</p> | <p>Maximum rotations • Обороти • Nr. maxim rotatii • Maksimalni broj obrtaja • Максимални вртежи • Максимальный вращения • Številni vrtitveji • Μέγιστες περιστροφές • Revolucije • Rotations maximale • Rotazioni massime • Maksimumaj rotacij • Rotações máximas</p> | <p>115 mm</p> | <p>Maximum diameter of grinding disc • Макс. диаметър на шлифовъчния диск • Diametru maxim disc slefuire • Maksimalni prečnik diska za šljafovanje • Макс. диаметар на дискот за брусьене • Максимальный диаметр шлифовального диска • Največji premer brusilnega diska • Μέγιστο διάμετρος δίσκου λειαντικού • Max. Promjer brusa • Diamètre maximum du disque de meulage • Diametro massimo del disco di levigatura • Maksimuma diametro de muelanta disko • Diâmetro máximo do disco de moagem</p> | <p>0-3 mm</p> | <p>Planning depth • Дълбочина на рендосване • Adancime maxima prelucrare • Dubina renđanja • Длабочина на стругање • Глубина строгания • Nastavljiva globina utora • Βάθος πλάνισματος • Dubina planiranja • Profondeur de planification • Profondità di pianificazione • Planado de profundo • Profundidade de planeamento</p> |
| <p>2 kg</p> | <p>Weight • Terno • Greutate • Težina • Тежина • Масса • Teža • Βάρος • Težina • Poids • Il peso • Peso • Carga</p> | <p>22.2 mm</p> | <p>Inner diameter of the disc • Втрешен диаметър на диска • Diametru interior disc • Unutrašnji prečnik diska • Напон • Внутренний диаметр дисков • Внатрешен диаметар на дискот • Εσωτερική διάμετρος του δίσκου • Unutarnji promjer diska • Diamètre intérieur du disque • Diametro interno del disco • Interna diametro de la disko • Diâmetro interno do disco</p> | <p>82 mm</p> | <p>Planning maximum width • Макс. ширина на рендосване • Latime maxima prelucrare • Maksimalna širina renđanja • Макс. ширина на стругање • Ширина строгания • Nastavljiva širina • Πλάτος πλάνισματος • Širina blanjanja • Planifier la largeur maximale • Pianificazione della larghezza massima • Planante maksimumam larjon • Largura máxima de planeamento</p> |
| | <p>Variable speed • Регулируеми обороти • Viteza variabila • Podešavanje broja obrtaja • Варијација на вртежи • Регулируемая скорость • Nastavljiva hitrost • Ρυθμιζόμενη ταχύτητα • Posedvi brzine • Vitesse variable • Velocità variabile • Varia rapido</p> | | <p>Spindle lock • Блокровка на вала • Buton blocare ax • Блокатор talasa • Блокада на вратилото • Блокровка шпинделя • Snemalni gumb • Το κλειδίμα του άξονα • Zaključavanje osovine • Blocage de la broche • Blocco del mandrino • Spinita seruro • Bloqueio do eixo</p> | <p>0-12.5mm</p> | <p>Plunge depth • Ход на фрезоващата глава • Afundare maxima • Ujaz za glavu frezera • Од на главата на фрезата • Окуניתесь глубины • Stroke rezalna glava • Βάθος βουτιά • Potezom mljevenja glave • Profondeur de plongée • Profundità di immersione • Profundígu • Profundidade de mergulho</p> |
| | <p>Left-right rotations • Реверс • Rotatie stanga-dreapta • Rotacija u oba smera • Реверс • Реверс • Leva – desna rotacija • Αντίστροφη • Reversna Rotations gauche - droite • Rotazioni sinistra-destra • Maldekstre-dekstraj rotacioj • Rotações esquerda-direita</p> | <p>Ømax 13 mm</p> | <p>Maximum diameter of equipment • Максимален диаметър • Diametru maxim accesorii • Maksimalni prečnik • Максимален диаметар на опремата • Максимальный диаметр оборудование • Maksimalni premer orodja • Μέγιστο διάμετρος του εξοπλισμού • Maksimalni promjer • Diamètre maximum de l'équipement • Diametro massimo dell'attrezzatura • Maksimuma diametro de ekipajo • Diâmetro máximo do equipamento</p> | <p>0-200 °C</p> | <p>Temperature range • Температурен обхват • Interval temperatura • Temperaturni opseg • Опек на температура • Диапазон температура • Обмоте temperature • Εύρος θερμοκρασίας • Temperaturno područje • Ecart de température • Intervalo di temperatura • Temperaturo • Faixa de temperatura</p> |
| <p>1.5-13 mm</p> | <p>Chuck diameter • Размер патронник • Diametru interior mandrina • Dimenzije glave bušilice • Диаметар на футер • Диаметер патрона • Velikost glave • Дιаметροσ άξονα • Stezna glava veličina • Diamètre du mandrin • Diametro del mandrino • Chuck-diametro • Diâmetro do mandril</p> | <p>1200 mAh</p> | <p>Battery type and capacity • Тип батерия и капацитет • Tip si capacitate baterie • Tip baterije i kapacitet • Тип на батерия и капацитет • Аккумулятор и мощность • Моџ батерие • Τύπος μπαταρίας και ικανότητα • Vrsta baterije i kapacitet • Type de batterie et capacité • Tipo di batteria e capacità • Tipo de batería kaj kapacito • Tipo de bateria e capacidade</p> | <p>LCD DISPLAY</p> | <p>LCD Display • LCD Экран • Display LCD • LCD Ekran • LCD Экран • LCD дисплей • LCD Display • Οθόνιν LCD • LCD zaslon • Afichage LCD Display • Ekranu LCD • Ekranu LCD</p> |

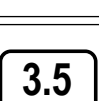
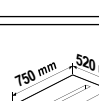

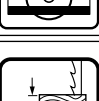
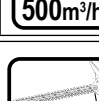
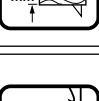































Meaning of Pictograms / Описание на Пиктограмите

| | | | | | |
|--|---|---|---|--|---|
|  | <p>Impact function • Ударна функция • Functie impact • Udarna funkcija • Ударна функција • Импакт функција • Udarne funkcija • Λειτουργία των επιπτώσεων • Udarce funkcio • Fonction d'impact • Funzione d'impatto • Trato funkcio • Função de impacto</p> |  | <p>Max. drilling diameter in metal • Макс. диаметър на пробиване в метал • Diametru maxim gaurire metal • Maks. prečnik probijanja kroz metal • Макс. диаметар на дупчење во метал • Макс. дијаметр сверления в металле • Maks. premer vrtanja v kovino • Μέγιστη διάμετρος τρυπήματος σε μέταλλο • Maks. promjer bušenja u metalu • Max. diamètre de perçage en métal • Max. diametro di foratura in metallo • Maks. boranta diametro en metalo • Max. diâmetro de perfuração em metal</p> |  | <p>Device is equipped with bulb or LED • Машината е снабдена с LED диод • Echipat cu bec sau LED • Mašina poseduje LED sijalicu • Уредот е опремен со LED Свјатилца • Устройство оснащено лампы или светодиода • Vsebuje žarnico ali LED žarnico • H συσκευή είναι εξοπλισμένη με λάμπα ή LED • Stroj sa LED diodom L'appareil est équipé d'une ampoule ou d'une LED • Il dispositivo è dotato di lampadina o LED • Aparato estas ekipita per ampolo aŭ LED • Il dispositivo è dotato di lampadina o LED • O dispositivo está equipado com lâmpada ou LED</p> |
|  | <p>Chuck thread • Резба на патронника • Mandrina tip • Navoj glave bušilice • Объем на вратилото • Тема Чака • Chuck temo • Тоак θεμά • Stezna glava provucite • Fil de mandrin • Filo di Chuck • Chuck-fadeno • Rosca de mandril</p> |  |  | <p>Working temperature • Работна температура • Temperatura de lucru • Radna temperatura • Работна температура • Рабочая температура • Temperatura • Θερμοκρασία λειτουργίας • Radna temperatura • Température de fonctionnement • Temperatura di lavoro • Laboranta temperaturo • Temperatura de trabalho</p> | |
|  | <p>Chuck diameter • Размер патронник • Diametru interior mandrina • Dimenzije glave bušilice • Дијаметар на футер • Диаметр патрона • Velikost glave • Трофобоција • Veličina stezna glava • Diamètre du mandrin • Diametro del mandrino • Chuck-diametro • Diâmetro do mandril</p> |  |  | <p>Flow capacity • Дебит на въздуха • Capacitate de evacuare • Capacitet struje • Капацитет на струјата • Производителность потока • Pretočnost • Ικανότητα ροής • Protok zraka • Capacité de débit • Portata • Flua kapacito • Capacidade de fluxo</p> | |
|  | <p>Maximum height • Максимална височина • Inaltime maxima • Maksimalna visina • Максимална висина • Максимална висота • Maksimalna višina • Μέγιστο ύψος • Maksimalna visina • Hauteur maximale • Altezza massima • Maksimuma alteco • Altura máxima</p> |  |  | <p>Working temperature • Работна температура • Temperatura de lucru • Radna temperatura • Работна температура • Рабочая температура • Temperatura • Θερμοκρασία λειτουργίας • Radna temperatura • Température de fonctionnement • Temperatura di lavoro • Laboranta temperaturo • Laboranta temperaturo • Temperatura de trabalho</p> | |
|  | <p>Diameter of abrasive disc • Дијаметар на шлифовачнија диск • Diametru disc abraziv • Prečnik diska za šljifovanje • Дијаметар на абразивниот диск • Дијаметр шлифовалног диска • Premer brusilnega diska • Διάμετρος δίσκου των λευκτικών • Promjer brusa • Diamètre du disque abrasif • Diametro del disco abrasivo • Diametro de abrasia disko • Diâmetro do disco abrasivo</p> |  |  | <p>Blade length • Дължина на режештата лента • Lungime lama • Dužina trake za sečenje • Должина на сечило • Длина клина • Dolžina rezanja traku • Μέκος λαιός • Duljina rezanja trake • Longueur de la lame • Lunghezza della lama • Klingo longeco • Comprimento da lâmina</p> | |
|  | <p>Base dimensions of finishing sander • Размери на шкурката • Dimensiunile bazei de slefuire • Dimenzije šmirgle • Дијаметар на базата на шлајферката • Базовые размеры отделочных шлифовальный • Основна dimenzija brusnega papirja • Διαστάσεις βάσης της τριβείο φινιρίσματος • Veličina brusnim papirrom • Dimensions de base de la ponceuse de finition • Dimensioni di base della levigatrice di finitura • Dimensioni di base della levigatrice di finitura • Bazo-dimensioj de finado de polvro • Dimensões de base da lixadeira de acabamento</p> |  |  | <p>Teeth per inch • Брой зъби на инч • Dinti per 1 Inch • Број зуби по инч • Број на зъби на инч • Зуби на дюйм • Številó zob na palec • Δόντια ανά ίντσα • Број зуби по инчу • Dents par pouce • Dentí per pollice • Dentoj po colo • Dentes por polegada</p> | |
|  | <p>Belt transport speed • Скорост на лентата • Viteza curea transmisie • Brzina trake • Издржливиост на ременот • Скорост протягивания ленти • Hitrost krožnega brusilca • Ταχύτητα ταινίας • Brzina trake • Courroie de transport • Velocità di trasporto della cinghia • Rapido de transporte de zona • Velocidade de transporte da correia</p> |  |  | <p>Pendulum movement position • Позиции на махаповидното движение • Pozitie reglabila • Pozicije klatnastog rotovanja • Позиција на поклањаче • Положение маятника движение • Nihajnega pretok položaja • Εκκρεμές θέση κίνησης • Položaj kretanja klatna • Pendolo movo pozicio • Posizione del movimento del pendolo • Pendolo movo pozicio • Posição do movimento pendular</p> | |
|  | <p>Belt dimensions • Размери на шкурката за лентов шлайф • Dimensiuni curea transmisie • Dimenzija šmirgle za trakasto šljifovanje • Големина на шмирплата • Размери ленти • Dimenzija brusnega traku • Ζώνη διαστάσεις • Veličina papirrom za Trakna brusilica • Dimensions de la ceinture • Dimensioni della cinghia • Zonaj • Dimensões da correia</p> |  |  | <p>Blade size • Размер на ножа • Marime lama • Dimenzije noža • Големина на ножот • Размер лезвия • Velikost rezila • Μέκος λαιτός • Veličina nožem • Taille de la lame • Dimensione della lama • Klingo grandeco • Tamnaha da lâmina</p> | |
|  | <p>SDS Plus chuck • Патронник SDS+ • Mandrina SDS Plus • Burgija SDS Plus • Футер SDS Plus • SDS plus Чак • Vpetje SDS+ • Тоак SDS+ • Stezna glava SDS+ • Mandrin SDS Plus • SDS+ chuck • Chuck SDS+ • Mandril SDS Plus</p> |  |  | <p>Maximum width of the workpiece • Максимална ширина на обработанија детал • Dimensiune maxima de prelucrat • Maksimalna širina obradivog predmeta • Максимална широчина на работното парче • Максимална ширина заготовки • Največja širina obdelovanca • Μέγιστο πλάτος του τεμαχίου • Maksimalna širina komada • Largeur maximale de la pièce • Larghezza massima del pezzo • Maksimuma laržo de la peco • Largura máxima da peça de trabalho</p> | |
|  | <p>Scope of moment • Въртящ момент • Cuplu maxim • Obrtni momenat • Вртежен момент • Крутящий момент • Моќ в Nm • Ροπή • Zakretnog momenta • Couple • Momento torcente • Paro • Esforço de torção</p> |  |  | <p>Cutting angle adjustment • Рязане под ъгъл • Ajustare unghi taiere • Sečenje pod uglom • Сечење под арон • Регулировка угла резания • Nastavljiv kot rezanja • Κοπή ρύθμιση γωνίας • Kut rezanja • Réglage de l'angle de coupe • Regolazione dell'angolo di taglio • Anglestigta angulo • Ajuste do ângulo de corte</p> | |
|  | <p>Sockets dimensions • Размер вложки • Dimensiuni adaptor • Dimenzije utičnice • Дијаметар на продолжетокот • Сокетими размери • Utičnice dimenzije • Πρίζες διαστάσεις • Veličina umeci • Dimensions des douilles • Dimensiuni prese • Kovrondimensioj • Dimensões dos soquetes</p> |  |  | <p>Max load • Максимален товар • Încărcătură maximă • Maksimalno opterećenje • Максимален товар • Максимална нарузка • Največja obremenitev • Μέγιστο φορτίο • Maksimalni opterećenje • Charge maximale • Carico massimo • Maksimuma šaržo • Carregamento máximo</p> | |











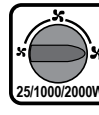
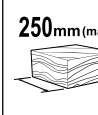



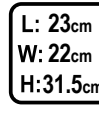
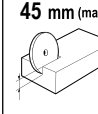













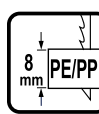
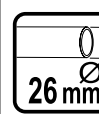

Meaning of Pictograms / Описание на Пиктограмите

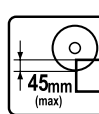
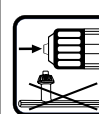
| | | | |
|--|---|--|--|
|  <p>2.8 cfm 79.2L/min</p> | <p>Avg. Air Consumption • Консумация на въздух • Consum aer/Putere absorbtie aer • Konzumacija vazduha • Консумация на въздух • Потребление воздуха • Poraba zraka • Κατανάλωση Αέρα • Потрошња zraka • Consumption d'air • Consumo d'aria • Aera konsumo • Consumo de ar</p> |  <p>0.8, 3.2 Ø mm</p> | <p>Diameter collet • Диаметр на цангата • Diametru mandrina freza electrica • Prečnik stezne čaure • Диаметр на футер • Цанговий диаметр • Premer stročnic • Διάμετρος τοοκ • Promjer stezne čahure • Diamètre des manchons • Diametro delle maniche delle pinze • Pinča manjiko diameter • Diâmetro de mangas</p> |
|  <p>52 cm</p> | <p>Log length • Дължина на дървото • Lungime bustean • Dužina drveta • Должина на дрвото • Дължина дървета • Dolžina drevesa • Μήκος του δέντρου • Dujina stabla • Longueur du journal • Lunghezza del registro • Log longa • Comprimento do log</p> |  <p>600ml</p> | <p>Container capacity • Объем на контейнера • Capacitate recipient • Kapacitet kontejnera • Капацитет на контейнерот • Объем контейнера • Prostornina posode • Όγκος βουξίου • Volumen spremnika • Capacité du conteneur • Capacità del contenitore • Kapabilo • Capacidade do recipiente</p> |
|  <p>50-250cm</p> | <p>Log diameter • Диаметр на дървото • Diametru bustean • Prečnik drveta • Диаметр на дрвото • Диаметр дървета • Premer drevesa • Διάμετρος του δέντρου • Promjer stabla • Diamètre de la bûche • Diametro del registro • Diametro de stipo • Diâmetro do log</p> |  <p>80L</p> | <p>Dust bag capacity • Объем на торбата за прах • Capacitate sac colector • Zapremina torbe za prašinu • Капацитет на торба за прашина • Емкост мешка для сбора пыли • Prostornina vrečke za prah • Χωρητικότητα σακούλας • Objam vrećice za prašinu • Capacité du sac à poussière • Capacità del sacchetto di polvere • Kapabla saketo • Capacidade do saco de poeira</p> |
|  <p>7500min⁻¹</p> | <p>Blade revolutions per minute • Обороти на ножа • Rotatii pe minut • Lama • Obrtaji noža • Вртежи на ножот во минута • Клинок оборотов в минуту • Režilo vrtljajev na minuto • Летѝба стpоуѝс оуѝ летѝто • Brzina nožem • Tours de lame par minute • Rotazioni della lama al minuto • Klingo-revolucioji je minuto • Rotações da lâmina por minuto</p> |  <p>102mm</p> | <p>Connector diameter • Диаметр на конектора • Diametru conector • Prečnik konektora • Диаметр на конекторот • Конектор диаметра • Priključek premera • Διαμέτρος σύνδεσης • Promjer priključka • Diametro de konektio • Diametro del connettore • Diâmetro do conector</p> |
|  <p>5000min⁻¹</p> | <p>Cord revolutions per minute • Обороти на кордата • Rotatii pe minut • Fir • Obrtaji strune • Вртежи на корецот во минута • Скорост шпaгaт • Hitrosti vrvi • Τοχύτητα νήματος • Brzina viti • Tours de corde par minute • Rotazioni del cavo al minuto • Kabloturmaj je minuto • Rotações de cabo por minuto</p> |  <p>3 A</p> | <p>AC Current • Големина на тока • Amperaj • Struja • Тек • Переменный ток • Izmenični tok • Εναλλασσόμενο ρεύμα • Veličina struje • Courant alternatif • Corrente AC • AC-Fluo • Corrente alternada</p> |
|  <p>255mm</p> | <p>Blade diameter • Диаметр на ножа • Diametru lama • Prečnik noža • Диаметр на ножот • Диаметр лезвия • Premer rezila • Διάμετρος λαιός • Promjer noža • Diamètre de la lame • Diametro della lama • Klingo diameter • Diâmetro da lâmina</p> |  <p>18 V</p> | <p>Voltage • Напрежение • Voltaj • Voltaža • Нaпoн • Напряжение • Napetost • Δυναμικό • Napon • Tension • Voltaggio • Tensio • A tensão</p> |
|  <p>4 tons</p> | <p>Maximum splitting force • Максимална сила на цепене • Forta maxima de spintecare • Maksimalna snaga seranja • Максимална сила на цепене • Максимальная сила расщепления • Najveća serpilna sila • Μέγιστη δύναμη σχίσματος • Maksimalna snaga razbijanje • Force de fente maximale • Massima forza di spaccatura • Maksimuma forta • Força máxima de divisão</p> |  <p>COLOR BOX</p> | <p>Wrap in Color box • Опаковано в цветна кутия • Ambalaj colorat • Ураковано и kutiji u boji • Спакувано во кутија • Оберните в коробе цвета • Zavijte ga u rolju barva • Τυλίξτε σε κουτί χρώματος • Pakiranjа u kutiji u boji • Envelopper dans la boîte de couleur • Avvolgi nella scatola dei colori • Envolviño en kolora skatolo • Embrulhar em caixa de cor</p> |
|  <p>3 functions</p> | <p>Functions of chiselling and drilling • Функции на къртене и пробиване • Funcțiile dăltuire și găurire • Funcție ștețovanje i bušenje • Функции на къртене и дупчење • Функции долбленија и сверленија • Funkcije Dletenje in vrtanje • Λετοურύξис του καλέμιου και τρύπανα • Funkcije dijelom i bušenje • Fonctions de burnage et de forage • Funzioni di cesellatura e foratura • Funkcioj de dziło kaj borado • Funções de cinzelamento e perfuração</p> |  <p>impeller X6</p> | <p>Number of impellers • Брой на турбините • Numărul de turbinelor • Broj turbinama • Број на турбините • Количество турбинама • Število turbin • Αριθμός τουρμπίνες • Broj turbine • Nombre d'impérateurs • Numero di impreatori • Nombro de impellers • Número de impellers</p> |
|  <p>3.5 J</p> | <p>Hammer energy per stroke • Макс. енергия на единичен удар • Max. energie provenind un pumn singur • Maks. energija jednog udarca • Макс. енергия на еден удар • Макс. Енергия, получаемая одним ударом • Max. energija, pridobijena en udarec • Max. Енергија поу троухрѝтати једнoг удaрoчa • Max. energija jednog potezu • Marteau energie per coup • Energia del martello per colpo • Martela energio per streko • Energia do martelo por curso</p> |  <p>750 mm x 520 mm</p> | <p>Table dimensions • Размери на работния плот • Dimensiuni masa de lucru • Dimenzije radne površine • Димензи на работна плоча • Размери рабочего • Namizne dimenzij • Διαστάσεις επιφάνειας εργασίας • Dimenzije radna površina • Dimensions de la table • Dimensioni della tabella • Tabla-dimensioj • Dimensões da mesa</p> |
|  <p>610mm (max)</p> | <p>Cutting length • Дължина на рязане • Lungime taiere • Dužina sečenja • Должина на сечење • Дължина реза • Dolžina rezanja • Κοπή μήκος • Dujina rezanja • La longueur de coupe • Lunghezza di taglio • Trañca longo • Comprimento de corte</p> |  <p>2x GEARS</p> | <p>Gears • Скорости • Pinioane • Zupčaniци • Запчаници • Передачи • Zobnici • Γρανάζια • Brzine • Engrenages • ingranaggi • Gears • Engrenagem</p> |
|  <p>65 mm</p> | <p>Cutting depth in wood • Дълбочина на рязане в дърво • Adâncime taiere in lemn • Dubina sečenja kroz drvo • Длабочина на сечење во дрво • Глубина пропила в дрвесине • Globina reza • Βάθος κοπής σε ξύλο • Dubina rezanja u drvu • Profondeur de coupe dans le bois • Profondità di taglio in legno • Trañca profundo en ligno • Profundidade de corte em madeira</p> |  <p>6 mm</p> | <p>Hose inner diameter • Втрешен диаметр на маркуча • Diametru interior furtun • Unutrašnji prečnik creva • Внатрешен дијаметар на цревето • Внутренний диаметр шланга • Notranji premer cevi • Συλλήγνα εσωτερικής διαμέτρου • Unutarnji promjer cijevna • Diamètre intérieur du tuyau • Diametro interno del tubo • Diâmetro interno da mangueira</p> |
|  <p>8 mm</p> | <p>Maximum cutting depth in metal • Макс. дълбочина на рязане в метал • Adâncime maximă de tăiere în metal • Maksimalna dubina sečenja kroz metal • Максимална длабочина на сечење во метал • Максимальная глубина резания металлов • Najveća globina reza u kovino • Μέγιστο βάθος κοπής μετάλλων • Maks. dubina rezanja u metalu • Profondeur de coupe max en métal • Massima profondità di taglio in metallo • Maksimuma trañca profundo en metalo • Profundidade máxima de corte em metal</p> |  <p>2.4mm</p> | <p>Cord diameter • Диаметр на кордата • Diametru cablu • Prečnik strune • Диаметр на кабелот • Шур дијаметром • Niz premer • Διαμέτρος καλωδίου • Promjer viti • Diamètre du cordon • Diametro del cavo • Korda diameter • Diâmetro do cordão</p> |
|  <p>max 11 mm</p> | <p>Cutting capacity (max) • Рязане капацитет (max) • Capacitate maxima taiere • Kapacitet sečenja (max) • Макс. Капацитет на сечење • Режущая способность (макс) • Rezanje (max) • Διεισδυτική κοπή (max) • Rezanje kapaciteta (max) • Capacité de coupe (max) • Capacità di taglio (max) • Trañcantá kapacito (maksimumo) • Capacidade de corte (max)</p> |  <p>x50</p> | <p>Sanding sheets quantity • Брой шкурки в комплекта • Nr. coli pentru slefuire • Broj šmirgli u kompletu • Број на шмиргли • Шлифистичко количество • Brusilni listi količina • Φύλλα λείανσης ποσότητα • Broj brusnih papirum • Quantité de feuilles de ponçage • Quantità di fogli abrasivi • Sanding sheet-kvanto • Quantidade de folhas de lixamento</p> |

Meaning of Pictograms / Описание на Пиктограмите

| | | | |
|--|--|--|---|
|  <p>196 cm³</p> | <p>Cylinder displacement • Работен обем на двигателя • Dislocare cilindrica • Radna zapremina motora • Работна зафатина на цилиндерот • Рабочий объем цилиндра • Valja • Κυβισμός • Capacitat motora • Déplacement de cylindre • Cilindrata • Cilindra movo • Deslocamento do cilindro</p> |  <p>1/2" inch</p> | <p>Wrench size • За вложки • Dimensiune cliket • Za uložke • Големина на вложката • Размер ключа • Velikost ključa • Μέγεθος κλειδιού • Za umetnica • Taille de la clé • Misura della chiave • Slosila grandeco • Tamanho da chave</p> |
|  <p>min H 180 mm</p> |  <p>Case packing • Куфар • Cutie • Upakovano u koferu • Купер • Чемодан • Zadeva pakiranje • Υπόθεση Συσκευασία • U kofer Emballage de cas • Imballaggio della cassa • Skatola pakado • Embalagem da caixa</p> |  <p>Pmax 0.7 MPa</p> | <p>Maximum pressure • Максимально работно налягане • Maxima presiune de lucru • Maksimalni radni pritisk • Максимальна работна притисок • Максимальное рабочее давление • Najveća delovni tlak • Μέγιστη πίεση εργασις • Maksimalni radni tlak • Pression maximale • Pressione massima • Maksimuma premo • Pressão máxima</p> |
|  <p>max H 340 mm</p> |  <p>Blister packing • Опаковка блистер • Blister • Upakovano u kesji • Блистер пакување • Блистерной упаковки • Pretisni pakiranje • Συσκευασία Κυψέλη • Emballage blister • Imballaggio in blister • Blister-pakado • Embalagem blister</p> |  <p>P 0.5 MPa</p> | <p>Working pressure • Работно налягане • Presiune de lucru • Radni pritisk • Работен притисок • Рабочее давление • Delovni tlak • Πίεση λειτουργίας • Radni tlak • Pression de travail • Pressione lavorativa • Laboranta premo • Pressão no trabalho</p> |
|  <p>max H 110 mm</p> |  <p>220V-50Hz</p> |  <p>16-40mm</p> | <p>Staples width • Височина на скобите • Latime carpe • Širina municije za heftanje • Ширина на муницијата • Ширина скобках • Širina objemke • Πλάτος του σφιγκτήρα • Visina zagradi • Largeur des agrafes • Larghezza delle graffette • Bukloj largó</p> |
|  <p>max H 50 mm</p> |  <p>Manual start the engine • Ръчно стартиране на двигателя • Pomire manuala • Ručno stratiranje motora • Рачно стартување на моторот • Ручной запуск двигателя • Ročni zaopn motora • Χειροκίνητη εκκίνηση του κινητήρα • Ručno pokretanje motora • Démarrage manuel du moteur • Manuale avvia il motore • Manilbro startigas la motoron • Manual de arranque do motor</p> |  <p>5.7mm 1.2mm</p> | <p>Staples dimensions • Размер на скобите • Dimensiuni carpe • Dimenje municije za heftanje • Големини на муницијата • Размер скобках • Velikost nosici • Μέγεθος σφιγκτήρα • Velicina zagradi • Largura dos grampos</p> |
|  <p>3m</p> |  <p>1.6-4mm</p> |  <p>100 pcs</p> | <p>Number of nails in the magazine • Брой пириони в пълнителя • Numărul de cuie în revista • Брой еккера у магазину • Брой на клинци во пълнителя • Количество гвоздей в магазине • Število žebeljev v reviji • Αριθμός κορδών στο περιόριο • Broj noktiju u magazini • Nombre de clous dans la cartouche • Numero di chiodi nella cartuccia • Nombro da ungoj en la kartoĉo • Número de pregos no cartucho</p> |
|  <p>500gr</p> |  <p>Ø120 mm</p> |  <p>30 pcs/min</p> | <p>Nails per minute • Брой пириони в минута • Cuie pe minut • Ekseri u minuti • Клинци во минута • Гвозди в минуту • Žebli na minuto • Κορδών ανά λεπτό • Broj noktiju minuti • Ongles par minute • Unghie al minuto • Najloj por minuto • Unhas por minuto</p> |
|  <p>500mm</p> |  <p>6-12 m</p> |  <p>15-50mm</p> | <p>Nails length • Дължина на пирионите • Lungime cuie • Diametriu eckera • Должина на клинци на пълнителя • Гвозди динии • Žebli dolžina • Κορδών μήκος • Duljina noktiju • Longueur des ongles • Lunghezza dei chiodi • Longa ungoj • Comprimento de unhas</p> |
|  <p>max 5mm</p> |  <p>Ø5.7mm</p> |  <p>H D</p> | <p>Nails dimensions • Размер на пирионите • Dimensiune cuie • Dimenjeje eckera • Големина на клинциот • Гвозди размери • Žebli dimenzije • Κορδών διαστάσεις • Velicina noktiju • Dimensions des ongles • Dimensiuni dei chiodi • Dimensiaj ungoj • Dimensões de unhas</p> |
|  <p>560mm 360mm</p> |  <p>22 + 1</p> |  <p>0.058" (1.5mm)</p> | <p>Thickness of units of the chain leading • Дебелина на водещите звена • Grosime zale lant • Debljina zubaca • Дебелина на водичката на забецот • Толщина единици цели водещих • Debljina vodilnih enot • Πάχος των μονάδων της αλυσίδας οδηγών • Debljina od vodečih jedinica • Epaisseur des unités de la chaîne en tête • Spessore delle unità della catena che porta • Dikeco de unuoj de la ĉeno kondukanta • Espessura das unidades da cadeia principal</p> |
|  <p>DUST CAPTURE ПРАХО-УПЛАВЯНЕ</p> |  <p>0-40 000 min⁻¹</p> |  <p>X 72</p> | <p>Number of units of the chain leading • Брой на водещите звена на верига • Capacitate rezervor combustibil • Broj zubaca u lancu • Брой на заци на ланецот • Число единици цели водещих • Število enot v verigi, ki vodijo • Αριθμός μονάδων της αλυσίδας που οδηγεί • Broj jedinica vodećeg lanca • Nombre d'unités de la chaîne en tête • Numero di unità della catena che porta • Nombro da unuoj de la ĉeno kondukanta • Número de unidades da cadeia principal</p> |
|  <p>3/4"</p> |  <p>CONCRETE</p> |  <p>0.325"</p> | <p>Chain pitch • Стъпка на веригата • Pas pentru lant • Korak lanca • Вредност на веригата • Шаг цели • Pogonski korak • Βήμα αλυσίδας • Koraci lanca • Pas de la chaîne • Passo della catena • Ĉenpaŝo • Passo em cadeia</p> |

Meaning of Pictograms / Описание на Пиктограмите

| | | |
|--|---|---|
|  <p>Maximum drilling diameter with holesaw arbor • Макс. диаметър на пробиване с боркорона • Diametru maxim găurire carota • Maks. prečnik probijanja s krunska glava • Макс. диаметар на дупченье с круна • Макс. диаметър сверления с коронка • Maksimalni premer vranja krona • Διάμετρος τριπύρατος σε κορυφή • Bušenje s Kruna • Diamètre de perçage maximum avec arbre de sciage • Diametro massimo di foratura con albero a sega • Maksimuma borado diametro kun holesaw arbor • Diámetro máximo de furação com mandril de furos</p> |  <p>Power settings • Степени на мощност • Setările de putere • Postavke paražanja • Степени на мојност • Настройки питания • Nastavitve porabe • Ρυθμίσεις ενέργειας • Postavke paražanja • Paramètres de puissance • Impostazioni di potenza • Potencaj agorđoj • Configurações de energia</p> |  <p>Maximum width of the workpiece • Максимална ширина на обработвания детал • Dimensiune maxima de prelucrat • Maksimalna širina obradivog predmeta • Максимална широчина на работното парче • Максималная ширина заготовки • Najveća širina obdelovanca • Μέγιστο πλάτος του τεμαχίου • Maksimalna širina komada • Largeur maximale de la pièce • Larghezza massima del pezzo • Maksimuma larđo de la peco • Largura máxima da peça de trabalho</p> |
|  <p>Oscillations • Осцилации • Oscilație • Oscilação • Oscilazioni • Oscillations • Oscilazioni • Oscilaj • Oscilações</p> |  <p>Heated area • Отопляема площ • Zona încălzită • Grejana površina stambenih • Загрева површина • Оттапливаемое помещение • Ogrevanih prostor • Огріваний періоду • Grijanu prostorju • Zone chauffée • Area riscaldata • Varmigita areo • Área aquecida</p> |  <p>Planing depth • Дълбочина на рендосване • Adancime maxima prelucrare • Dubina rezanja • Длабочина на стругане • Глубина строгания • Nastavljiva globina utora • Βάθος πλάνισματος • Dubina planiranje • Profondeur de planification • Profundità di planificazione • Planado de profundo • Profundidade de planejamento</p> |
|  <p>Oscillations angle • Ъгъл на осцилациите • Unghiul Oscilație • Oscilação unjo • Осцилации под агол • Угол Осцилляция • Κοί Oscilacja • Γωνία Ταλάντωσης • Kut Osciliranja • Angle des oscillations • Angolo delle oscillazioni • Osciloj-angulo • Angulo de oscilação</p> |  <p>Length, width and height • Дължина, ширина и височина • Lungimea, lățimea și înălțimea • Dužina, širina i visina • Должина, ширина и висина • Дина, ширина и высота • Dolžina, širina in višina • Μήκος, το πλάτος και το ύψος • Dužina, širina i visina • Longueur, largeur et hauteur • Longueur, largeur et hauteur Longueur, largeur et hauteur • Comprimento, largura e altura</p> |  <p>Maximum cutting depth • Максимална дълбочина на рязане • Adancime maxima de taiere • Maksimalna dubina sečenja • Максимална длабочина на сеченье • Максималная глубина пропила • Najveća dubina reza • Μέγιστο βάθος κοπής • Najveća dubina rezanja • Profondeur de coupe maximale • Massima profondità di taglio • Maksimuma tranča profundo • Profundidade máxima de corte</p> |
|  <p>Warm-up time • Време за загряване • Timp de incalzire • Vreme zagrevanja • Време за загревање • Время прогрева • Cas toplo • Χρόνος προθέρμανσης • Toplo vrijeme • Temps de préchauffage • Tempo di riscaldamento • Varmigita tempo • Hora de aquecimento</p> |  <p>Ingoing amount air • Входящо количество въздух • Intrăni aer • Ulazi vazduha • Дојдовен количество воздух • Входи воздуха • Входи zraka • Είσοδος αέρα • Ułaza zraka • Quantitè d'air entrant • Quantità d'aria in entrata • Enirado de aero • Quantidade de entrada de ar</p> |  <p>Cutting length • Дължина на рязане • Lungime taiere • Dužina sečenja • Должина на сеченье • Должина реза • Najveća dubina reza • Μέγιστο βάθος κοπής • Dujina rezanja • La longueur de coupe • Lunghezza di taglio • Tranča longo • Comprimento de corte</p> |
|  <p>Liquid volume • Капацитет • Volum • Capacitet • Капацитет • Емкост • Zmogljivost • Χωρητικότητα • Kapacitet • Volume de liquide • Volume liquido • Likva volumo • Volume liquido</p> |  <p>Outgoing air quantity • Изходящо количество въздух • Cantitate de aer de ieșire • Odlazeci količina vazduha • Појдовен количество воздух • Исходящие количество воздуха • Odlazni količina zraka • Εξέρχόμενη ποσότητα αέρα • Odlazni količina zraka • Quantitè d'air sortant • Quantità d'aria in uscita • Kvantò de ekstera aeron • Quantidade de ar de saída</p> |  <p>Flow rate • Скорост на струята • Debitul • Protok • Брзина на млазот • Скорост потока • Pretok • Ένας ρυθμός ροής • Protok • Debit • Portata • Fluo-rapideco • Quociente de vazão</p> |
|  <p>Nozzle diameter • Диаметър на дюзата • Diametru duza • Prečnik mlaznice • Дијаметар на динзата • Диаметр сопла • Premer šobe • Διάμετρος πτεκ • Promjer mlaznice • Diamètre de la buse • Diametro dell'ugello • Nozzle diametro • Diámetro do bico</p> |  <p>Capacity bag leaves • Капацитет на торбата за листа • Frunze sac Capacitate • Kapacitet jastuk lišće • Капацитет на торбата за листови • Вместимость мешка листьев • Zmogljivost torba listi • Φύλλα σακούλα χωρητικότητας • Kapacitet jastuka lišće • Capacité sac feuilles • Foglie di capacità • Folioj de sako • Folhas de saco de capacidade</p> |  <p>Capacity • Капацитет • Volum • Capacitet • Капацитет • Емкост • Zmogljivost • Χωρητικότητα • Kapacitet • Capacité • Capacità • Kapablo • Capacidade</p> |
|  <p>Maximum piston stroke • Максимален ход на буталото • Deplasare maxima piston • Maksimalni hod potiskivača • Максимален од на осовината • Максимальный ход • Najveći gib • Μέγιστο εκκεφαλικό ετπεσόδιο • Maksimalni hod • Course maximale du piston • Corsa massima del pistone • Maksimuma streketo • Curso máximo do pistão</p> |  <p>Width of milling • Ширина на фрезование • Lățime de frezare • Širina mlevenja • Ширина на гладане • Ширина фрезерования • Širina rezkanja • Πλάτος του άλεσης • Širina glodanje • Largeur de fraisage • Larghezza della fresatura • Largeco de moliđo • Largura da moagem</p> |  <p>Blade Diameter • Диаметър на ножа • Diametru lamă • Prečnik oštrice • Дијаметар на ножот • Диаметр лезвия • Premer rezila • Διάμετρος λετρίδος • Promjer noža • Diamètre De La Lame • Diametro lama • Klingo Diameter • Diámetro de la Lámina</p> |
|  <p>Milling depth • Дълбочина на фрезование • Adancime de rutare • Dubina rutiranje • Длабочина на меленье • Глубина фрезерования • Globine rezkanja • Βάθος άρολιόλησης • Dubine glodanja • Profondeur de fraisage • Profundità di fresatura • Muelanta profundo • Profundidade de moagem</p> |  <p>Type of cable • Вид на кабела • Tipul de cablu • Tip kabla • Вид на кабелот • Тип кабела • Vrsta kabla • Τύπος καλωδίου • Vrsta kabela • Type de cable • Tipo di cavo • Tipo de kablo • Tipo de cabo</p> |  <p>Maximum size of solids • Максимален размер на твърдите частици • Dimensiunea maximă a solidelor • Maksimalna veličina čvrstih materija • Максимална големина на цврсти материи • Макс. размер твердых частиц • Maksimalna velikost trdnih delcev • Μέγιστο μέγεθος των στερεών • Maksimalna veličina krutih tijela • Taille maximale des solides • Dimensione massima dei solidi • Maksimuma grandeco de solidoj • Tamanho máximo de sólidos</p> |
|  <p>Max cutting depth in PE / PP • Макс дълбочина на рязане в PE / PP • Adancime maxima de taiere în PE / PP • Maks. dubina sečenja kroz PE / PP • Максимална длабочина на сеченье во PE / PP • Максимальная глубина резания PE / PP • Najveća globina reza v PE / PP • Μέγιστο βάθος κοπής PE / PP • Maks. dubina rezanja u PE / PP • Profondeur de coupe max en PE / PP • Profundità di taglio massima in PE / PP • Maksimuma tranča profundo en PE / PP • Profundidade máxima de corte em PE / PP</p> |  <p>Pipe diameter • Диаметър на тръбата • Diametru teava • Prečnik cevi • Дијаметар на тръбата • Диаметр трубы • Premer cevi • Διαμέτρο σωλήνων • Promjer cijevi • Diamètre du tuyau • Diametro del tubo • Tubo diametro • Diámetro do tubo</p> |  <p>Grass cutting height • Височина на косене • Înaltime taiere iarba • Visina košenja • Височина на косенье • Высота стрижки травы • Visina Sprej • Υψος ψεκστοίου • Visina pskanje • Gamme de liquide verticale • Gamma di liquidi verticale • Likva gamo vertikalna • Vertical liquido</p> |
|  <p>Maximum cutting depth • Максимална дълбочина на рязане • Adancime maxima de taiere • Maksimalna dubina sečenja • Максимална длабочина на сеченье • Максималная глубина пропила • Najveća globina reza • Μέγιστο βάθος κοπής • Najveća dubina rezanja • Profondeur de coupe dans le bois • Profundità di taglio in legno • Tranča profundo en ligno • Profundidade de corte em madeira</p> |  <p>Keyless chuck • Бързоазягащ патрончик • Mandrina rapida • Brzozatežajúsi dodatak • Брзо затегувачки футер • Быстрозажимной патрон • Hitrovrpenjalna vrtalna glava • Τοχυτόκος • Brzostezna glava • Mandrin sans clé • Mandrino senza chiave • Keyless chuck • Mandril sem chavre</p> |  <p>Basket capacity • Объем на кош за трева • Capacitate cos colector • Zapremina koře za travu • Капацитет на корпата за трева • Объем корзины травы • Obseg trave košarico • Όγκος υροστί καλάδι • Obujam prikupljanje trave • Capacité du panier • Capacità del cesto • Korpa kapacito • Capacidade do cesto</p> |
|  <p>Cable cord length • Дължина на кабела • Lungime cablu alimentare • Dužina kabla • Должина на кабелот • Дина кабела • Dolžina kabla • Καλώδιο μήκος • Duljina kabla • Longueur du cordon • Lunghezza del cavo • Longa snuro de kablo • Comprimento do cabo</p> |  <p>Grass cutting diameter • Диаметър на косене • Diametru taiere iarba • Prečnik košenja • Дијаметар на косенье • Диаметр стрижки травы • Premer pri rezanju • Διάμετρος κοπής χόρτου • Promjer košnje • Diamètre de coupe de l'herbe • Diametro di taglio dell'erba • Herbo de diametro • Diámetro de corte de grama</p> |  <p>Liquid range vertical • Височина на пръскане • Înălțimea pulverizare • Visina sprej • Висина на пръскане • Высота распыления • Visina Sprej • Υψος ψεκστοίου • Visina pskanje • Gamme de liquide verticale • Gamma di liquidi verticale • Likva gamo vertikalna • Vertical liquido</p> |
|  <p>Hose inner & outer diameter • Вътрешен и външен диаметър на маркуча • Diametru interior-exterior furtun • Unutrašnji i spojašnji prečnik ceva • Вънатрешен и надворешен диаметар на цревето • Шланг внутренни и внешний диаметр • Notranji in zunanji premer cevi • Σωλήνος εσωτερική & εξωτερική διάμετρο • Unutarnji i vanjski promjer cijeva • Diamètre intérieur et extérieur du tuyau • Diametro interno ed esterno del tubo • Hoso ena kaj ekstera diametro • Diámetro interno e externo da mangueira</p> |  <p>Oil tank capacity • Объем на резервоара за масло • Capacitate rezervor ulei • Zapremina rezervoara za ulje • Капацитет на резервоарот за масло • Емкост мляного бака • Prostorina rezervoarja olja • Χωρητικότητα δεξαμενής λαδιού • Obujam spremnika ulja • Capacité du réservoir d'huile • Capacità del serbatoio dell'olio • Kapacito de nafno-tanko • Capacidade do tanque de óleo</p> |  <p>Liquid range horizontal • Дължина на хоризонтално пръскане • Evacuare lichid la orizontala • Dužina horizontalno pskanja • Должина на пръскане хоризонтално • Дина хоризонталното распыление • Dolžina horizontalne razpršila • Μήκος των οριζόντιων ψεκστοίου • Duljina horizontalne pskanje • Gamme de liquide horizontale • Gamma di liquidi orizzontale • Likva gamo horizontalna • Intervalo liquido horizontal</p> |

Meaning of Pictograms / Описание на Пиктограмите

| | | | |
|----------------------|--|--------------------------------|---|
| <p>40 pcs</p> | <p>Accessory quantity • Брой в комплекта • Nr. Accesorii • Број комада у комплекту • Број на додатоци • Аксесуари количество • Dodatna količina • Ποσότητα Αξεσουάρ • Broj isporučuje • Quantité d'accessoire • Quantità di accessori • Aksesora kvanto • Quantidade acessória</p> | <p>8 mm</p> | <p>Fuel tank capacity • Объем на резервоара за гориво • Capacitate rezervor combustibil • Zapremina rezervoara za gorivo • Капацитет на резервоарот за гориво • Емкость топливного бака • Prostorina rezervoarja za gorivo • Χωρητικότητα δεξαμενών • Obujam spremnika goriva • Capacité du réservoir de carburant • Capacità della tanica di benzina • Kapacito de benzinujo • Capacidade do tanque de combustivel</p> |
| <p>1.8 m</p> | <p>Hose length • Дължина на маркуча • Lungime furtun • Dužina creva • Должина на црево • Длина шланга • Dolžina cevi • Μήκος σωλήνα • Dujlina crjeva • Longueur du tuyau • Lunghezza del tubo • Longitudo de tubo • Comprimento da mangueira</p> | <p>Length 100mm</p> | <p>18" 450mm</p> |
| | <p>Always wear protective mask • Винаги носете предпазна маска • Purtați masca de protecție • Uvek nosite zaštitnu masku • Задолжително користете заштитна маска • Всегда надевайте защитную маску • Vedno nosite zaščitno masko • Πάντα να φοράτε προστατευτική μάσκα • Uvijek nosite zaštitnu masku • Toujours porter un masque de protection • Indossare sempre una maschera protettiva • Ciam surhavas protektan maskon • Sempre use máscara de proteção</p> | <p>230mm 280mm</p> | <p>1.2 L/h</p> |
| | <p>Always wear protective earmuffs • Винаги носете антифони • Purtați casti de protecție pentru urechi • Uvek nosite zaštitu za uši • Задолжително користете заштитни слушалки • Всегда надевайте защитные наушники • Vedno nosite zaščitna muhi uho • На φοράτε πάντα προστατευτικά αυστοσπίδες • Uvijek nosite štítneke za uši • Toujours porter des cache-oreilles protecteurs • Indossare sempre cuffie antirumore • Ciam surhavas protektajn orellingojn • Use sempre protetores de ouvido protetores</p> | <p>LIQUID ≥ 4 L/min</p> | <p>AUTO</p> |
| | <p>Always wear protective glasses • Винаги носете предпазни очила • Purtați manusi de protecție • Uvek nosite zaštitne naočare • Задолжително користете заштитни наочари • Всегда надевайте защитные очки • Vedno nosite zaščitna očala • На φοράτε πάντα προστατευτικά γυαλιά • Uvijek nosite zaštitne naočale • Toujours porter des lunettes de protection • Indossare sempre occhiali protettivi • Ciam surhavas protektajn okulvitrojn • Use sempre óculos de proteção</p> | <p>DUST ≥ 6 L/min</p> | <p>0.14 sec</p> |
| <p>SDS+</p> | <p>SDS-plus Tip • Захаат SDS-plus • Tip SDS Plus • SDS-plus Tip • SDS Plus Тип • Пика SDS-Plus • SDS-plus Tip • Κορυφή SDS-plus • Nositelj SDS-plus • Conseil SDS-plus • Suggestimento SDS-plus • SDS-plus Tip • Dica SDS-plus</p> | <p>20 L</p> | <p>3/8" ID</p> |
| <p>SDS+</p> | <p>SDS-plus adapter • SDS-plus адаптер • Adaptor SDS plus • SDS-plus adapter • SDS Plus Адаптер • SDS-Plus адаптер • SDS-plus adapter • SDS-plus приспособление • SDS-plus adapter • Adaptateur SDS-plus • Adattatore SDS-plus • SDS-plus adaptilo • Adaptador SDS-plus</p> | <p>TANK 100L</p> | <p>1/4"</p> |



Марката Raider през годините

Уважаеми клиенти и партньори,

Пред вас е новият каталог на Raider 2020 год., където можете да намерите цялостни решения за Вашия бизнес сред богатия избор от акумулаторни, електрически, бензинови и пневматични машини и консумативи за тях. Този каталог включва 1630 артикули, от които 388 са нови.

Марката Raider е собствен бранд на Евромастер Импорт Експорт ООД, познат и утвърден на българския пазар от двадесет години. Разнообразието на машини в този бранд, покрива практически целия диапазон дейности - строителство, дървообработване, металообработване, авто и градинска техника. Предлагаме и пълна гама съответни консумативи, съвместими не само с машините с бранд Raider. След успешния старт през 2000 година, марката Raider не е изменила на визията и мисията си, базирани на потребностите и очакванията на потребителите. Съобразно тях сме обновили асортимента си, достигайки по-високо технологично равнище.

Ценностите, на които се гради успехът ни са:

- Технологично качество, отговарящо на високи професионални изисквания, на разумна, достъпна и конкурентна цена;
- Качество, на което клиентите се доверяват;
- Стабилни, открити и честни взаимоотношения с бизнес партньори, производители и дистрибутори;
- Професионална и лична отговорност за поетите рискове и взетите решения.

С новите машини и усъвършенстването на моделите, спечелили Вашето доверие с доказаното си качество, ние добавяме допълнителни ползи и предимства и адаптираме продуктите към пазарната среда, за да продължава Raider да бъде най-доброто предложение при избор на машини за интензивна работа при професионални условия.

След утвърждаването на продуктите в България, Raider успешно разширява дистрибуторската си мрежа и пазарния си дял в редица страни от Централна и Източна Европа.

Raider Brand over the years

Dear Customers and Partners,

The trademark Raider celebrates its 20th birthday anniversary during this year.

Now you have our new Raider product catalogue, where you can find complete solutions for your business among the wide selection of electric, gasoline and pneumatic equipment and consumables. This catalog includes 1630 articles, of which 388 are new.

Raider brand is Euromaster Import - Export Ltd. own brand known and recognized on Bulgarian market for twenty years. The variety of instruments with this brand covers practically the whole range of activities - construction, woodworking, metalworking, auto- and garden equipment. The variety of machines with this brand covers practically the whole range of activities - construction, woodworking, metalworking, auto- and garden equipment. We offer also a full range of related accessories, compatible not only with Raider brand machines.

After the successful launch in 2000, Raider brand has not altered its vision and mission based on the needs and expectations of consumers; we have upgraded its range accordingly, reaching a higher level of technology. The values upon which our success was built are:

- Technological quality meeting the highest professional requirements at a reasonable, affordable and competitive price;
- Quality that customers trust;
- Stable, open and honest relationships with business partners, manufacturers and distributors;
- Professional and personal responsibility for the taken risks and decisions.

With the new machines and improvement of models, which earn your trust with proven quality, we add additional benefits and advantages and adapt our products to the market environment to keep being RAIDER best deal when choosing a machine for intensive use in a professional environment.

With the recognition of the products in Bulgaria, Raider has been successfully expanding its market share and developing its distribution network in several countries of Central and Eastern Europe.

ЕВРОМАСТЕР Импорт Експорт ООД

Р. България, 1231 София,
бул. "Ломско шосе" 246
тел.: 0700 44 155 за цялата страна
e-mail: info@euromasterbg.com
www.euromasterbg.com

EUROMASTER Import Export Ltd.

Bulgaria, 1231 Sofia,
246 Lomsko Chaussee Blvd.
tel.: (00 359) 87 530 0101
e-mail: info@euromasterbg.com
www.euromasterbg.com

EUROMASTER SRL Romania

Str. Drumul Garii Otopeni,
Nr. 6, Otopeni, Ilfov
Tel.: +4 021 3510106
e-mail: info@euromasters.ro
www.euromasters.ro

"Евромастер Импорт Експорт" ООД, информира, че авторските права на този каталог, включващи неговия текст, поместените фотографии, пиктограми, схеми, чертежи и дизайн, принадлежат изключително на "Евромастер Импорт Експорт" ООД и подлежат на правна защита съгласно „Закона за авторското право и сродните му права“ влязъл в сила на 01.08.1993 г. и последните изменения публикувани в „Държавен вестник“ бр. 32 от 28 Април 2009 г.

Копирането, публикуването, модифицирането с комерсиална цел на каталога, както и на отделни елементи от него без съгласието на "Евромастер Импорт Експорт" ООД, изразено в писмена форма, е строго забранено и може да доведе до подвеждане под отговорност.

All rights reserved. Euromaster Import - Export Ltd informs that the copyright of this catalog, including its text, photographs, pictograms, diagrams, drawings and designs belong exclusively to Euromaster Import - Export Ltd and are subject to legal protection.

Copying, publishing, modifying the catalog with commercial purposes, as well as individual elements thereof without the consent of Euromaster Import - Export Ltd expressed in written form is strictly prohibited and may result in liability.

www.raider.bg

euromaster

 **0700 44 155**

 **info@euromasterbg.com**

 **www.raider.bg**

Art. № 108028



Euromaster Import - Export Ltd
Bulgaria
1231 Sofia
246, "Lomsko shose" blvd
www.raider.bg
www.euromasterbg.com
Tel.: +359 875 300 101

